

Traffic Impact Study

Proposed Dunkin' Coffee Shop
3 Dover Road (NH Route 108)
Durham, New Hampshire

Prepared for:

Tropic Star Development
321D Lafayette Road
Hampton, New Hampshire

February 2025

Prepared by:

 **Vanasse &
Associates inc**
Transportation Engineers & Planners

35 New England Business Center Drive
Suite 140
Andover, MA 01810

CONTENTS

EXECUTIVE SUMMARY	1
INTRODUCTION.....	4
Study Methodology	4
EXISTING CONDITIONS	5
Geometry	5
Existing Traffic Volumes	6
Pedestrian and Bicycle Facilities.....	7
Public Transportation Services.....	7
Motor Vehicle Crash Data.....	7
Vehicle Speed Measurements.....	8
FUTURE CONDITIONS	9
Future Traffic Growth	9
Project-Generated Traffic.....	10
Trip Distribution and Assignment.....	14
Future Traffic Volumes – Build Condition	14
Turn Lane Warrant Analyses.....	15
SIGHT DISTANCE EVALUATION.....	16
TRAFFIC OPERATIONS ANALYSIS	18
Methodology	18
Analysis Results	21
RECOMMENDATIONS AND CONCLUSIONS.....	25
Recommendations	28
Conclusions	29

FIGURES

No.	Title
1	Site Location and Study Area Map
2	Existing Intersection Lane Use, Travel Lane Width, and Pedestrian Facilities
3	2024 Existing Peak-Hour Traffic Volumes
4	2025 Opening-Year No-Build Peak-Hour Traffic Volumes
5	2035 Design-Year No-Build Peak-Hour Traffic Volumes
6	Trip Distribution Map
7	Existing Dunkin' Trips Redistributed
8	Proposed Dunkin' Trips Due to Expansion
9	2025 Opening-Year Build Peak-Hour Traffic Volumes
10	2035 Design-Year Build Peak-Hour Traffic Volumes
11	Conceptual Signage Plan

TABLES

No.	Title
1	2024 Existing Roadway Traffic-Volume Summary
2	Public Transportation Services
3	Vehicle Travel Speed Measurements
4	Existing Trip Generation Summary
5	Proposed Trip Generation Summary
6	Net New Trip Generation Summary
7	Trip-Distribution Summary
8	Peak-Month Peak-Hour Traffic-Volume Increases
9	Sight Distance Measurements
10	Level-of-Service Criteria for Signalized Intersections
11	Level-of-Service Criteria for Unsignalized Intersections
12	Signalized Intersection Level-of-Service and Vehicle Queue Summary
13	Unsignalized Intersection Level-of-Service and Vehicle Queue Summary
14	Mitigated Intersection Level-of-Service and Vehicle Queue Summary

EXECUTIVE SUMMARY

Vanasse & Associates, Inc. (VAI) has conducted a Traffic Impact Study (TIS) in order to determine the potential impacts on the transportation infrastructure associated with the proposed relocation of a Dunkin' coffee shop from the Irving gas station located at 4 Dover Road (NH Route 108) to 3 Dover Road in Durham, New Hampshire (hereafter referred to as the "Project"). This study has been completed in accordance with New Hampshire Department of Transportation (NHDOT) standards for the preparation of a TIS. This study evaluates the following specific areas as they relate to the Project: i) access requirements; ii) potential off-site improvements; and iii) safety considerations; and identifies and analyzes existing traffic conditions and future traffic conditions, both with and without the Project.

PROPOSED PROJECT

The Project will entail the construction of a 1,500 square foot (sf) Dunkin' coffee shop with indoor seating and no drive-through window facility to be located at 3 Dover Road (NH Route 108) in Durham, New Hampshire. The 1,100-sf Dunkin' coffee shop, currently located in the Irving gas station at 4 Dover Road, will be relocating to the new 1,500-sf facility at 3 Dover Road. The Project site currently contains a one-story vacant commercial building with an existing driveway to Dover Road. The Project is surrounded by residential buildings to the north and east, NH Route 108 to the south, and a hotel to the west.

EXISTING CONDITIONS

A comprehensive field inventory was conducted to collect existing roadway geometrics, traffic volumes, operating characteristics, speed limits, and sight distances, as well as land use information. Traffic volumes were collected in October and November 2024 at the intersections which are expected to accommodate the majority of Project-related traffic. The study area is listed below.

- Dover Road/Main Street at Newmarket Road/Holiday Inn Express driveway
- Dover Road at Irving gas station driveway
- Dover Road at Irving gas station driveway/Holiday Inn Express driveway
- Dover Road at Project site driveway

FUTURE CONDITIONS

Traffic volumes in the study area were projected to the years 2025 and 2035, which reflect the anticipated opening-year of the Project and a ten-year planning horizon from the opening-year, respectively, consistent with NHDOT guidelines. These conditions incorporate traffic growth due to general background traffic increases, as well as development projects, currently being proposed/permitted or under construction and expected to generate traffic in the future. This condition is referred to as the No-Build condition.

PROJECT-GENERATED TRAFFIC

As compared with the existing coffee shop, the expansion is expected to generate 232 additional vehicle trips on an average weekday with 49 additional vehicle trips during the weekday morning peak hour and 20 additional vehicle trips during the weekday evening peak hour. On Saturday, the Project is expected to generate 252 additional vehicle trips with 30 additional vehicle trips during the Saturday midday peak hour.

In total, the relocated coffee shop is expected to generate 868 vehicle trips on an average weekday with 183 vehicle trips (83 entering and 100 exiting) during the weekday morning peak hour and 75 vehicle trips (35 entering and 40 exiting) during the weekday evening peak hour. On a Saturday, the Project is expected to generate 946 vehicle trips with 111 vehicle trips (55 entering and 56 exiting) during the Saturday midday peak hour.

Project-related traffic-volume increases external to the study area relative to 2025 and 2035 No-Build conditions are anticipated to range from 1 to 13 vehicles or 0.1 to 1.1 percent during the peak periods.

TRAFFIC OPERATIONS ANALYSIS

Analysis indicates that the Project will generally result in minimal impact on motorist delays and vehicle queue lengths at the study intersections.

RECOMMENDATIONS

Access to the Project site will be provided via the curb cut onto Dover Road. It is suggested that the driveway be placed under a peak-hour exiting left-turn prohibition for 7-9AM and 4-6PM. During non-peak hours, the left turn movement may be able to be processed as both volumes exiting the site and volumes on Dover Road would be lower during off-peak periods.

The following recommendations are offered with respect to the design and operation of the Project site driveway:

- The Project site driveway should be designed to accommodate the turning and maneuvering requirements of the largest expected delivery and emergency vehicles.
- The driveway should be placed under STOP-sign (*Manual on Uniform Traffic Control*

Devices (MUTCD)¹ R1-1) control, with a painted STOP-bar included.

- All signs and other pavement markings to be installed within the Project site shall conform to the applicable standards of the current MUTCD.
- Signs and landscaping adjacent to the Project site driveways should be designed and maintained so as not to restrict lines of sight.
- Snow windrows within sight triangle areas of the Project site driveways should be promptly removed where such accumulations would impede sightlines.

CONCLUSIONS

As documented in this study, Project-related traffic increases will not result in significant increases in traffic volumes or traffic delays within the study area. Although the Project site driveway will operate with delay during peak hours, these delays will be realized on-site. The peak-period prohibition on left turns out of the site will allow operations on Dover Road, where motorists use the center turn lane as a de facto westbound left-turn lane, to continue as they currently exist.

The Project represents a redistribution of trips from an existing Dunkin' coffee shop to a new location across Dover Road; therefore, many of the existing trips are already on the road network. However, if the new site does not align with customers' travel patterns, they will most likely find other businesses to frequent. In general, Project-related traffic can be accommodated within the existing and future infrastructure with manageable impact to the general traffic operations within the study area.

¹*Manual on Uniform Traffic Control Devices (MUTCD)*; Federal Highway Administration; Washington, DC; 2009.

INTRODUCTION

VAI has conducted a TIS in order to determine the potential impacts on the transportation infrastructure associated with the proposed relocation of a Dunkin' coffee shop from the Irving gas station located at 4 Dover Road (NH Route 108) to 3 Dover Road in Durham, New Hampshire. This report identifies and analyzes existing and future traffic conditions both with and without the Project and reviews access requirements, potential off-site improvements, and safety considerations.

STUDY METHODOLOGY

This study was prepared in consultation with the Town of Durham and NHDOT; was performed in accordance with NHDOT guidelines for the preparation of a TIS and the standards of the Traffic Engineering and Transportation Planning Professions for the preparation of such reports; adhered to the traffic study scope agreed upon with NHDOT at the October 16, 2024 scoping meeting; and was conducted in three distinct stages.

The first stage of the study involved an assessment of existing conditions in the study area and included an inventory of roadway geometrics, pedestrian and bicycle facilities, and public transportation services; observations of traffic flow; and the collection of daily and peak-period traffic counts.

In the second stage of the study, the future conditions of the transportation system were projected and analyzed. Specific travel demand forecasts for the Project were assessed along with future demands on the transportation system that are expected due to growth independent of the Project. In accordance with NHDOT guidelines for the preparation of a TIS, four future conditions were evaluated: 1) 2025 Opening-Year No-Build conditions without the Project; 2) 2025 Opening-Year Build conditions with the Project; 3) 2035 Design-Year No-Build conditions without the Project; and 4) 2035 Design-Year Build conditions (ten-year projection from opening-year) with the Project. The analyses conducted in stage two of the study identify existing or projected future roadway capacity and traffic safety issues.

The third stage of the study presents and evaluates measures to address roadway and intersection capacity issues and safety concerns, if any, identified in stages one and two of the study.

EXISTING CONDITIONS

A comprehensive field inventory of existing conditions within the study area was conducted in November 2024. The field investigation consisted of an inventory of existing roadway geometrics and operating characteristics; as well as posted speed limits, sight distance, and land use information within the study area. Traffic volumes were collected in October and November 2024. The study area for the Project contains the major roadway that provides access to the Project, as well as the intersections that are expected to accommodate the majority of Project-related traffic. The study area is listed below and graphically depicted on Figure 1.

- Dover Road/Main Street at Newmarket Road/Holiday Inn Express driveway
- Dover Road at Irving gas station driveway
- Dover Road at Irving gas station driveway/Holiday Inn Express driveway
- Dover Road at Project site driveway

The following describes the study area roadway which provides access/egress to the Project.

GEOMETRY

Roadway

Dover Road

Dover Road is classified as a “minor arterial” roadway under NHDOT jurisdiction. Dover Road runs in a general east-to-west alignment throughout the study area and provides one general-purpose travel lane in each direction separated by a double-yellow centerline with turn lanes provided at some intersections. Land use along Dover Road throughout the study area generally consists of commercial properties.

Intersections

Figure 2 summarizes existing lane use, travel lane widths, and sidewalk and crosswalk locations at the study area intersections.

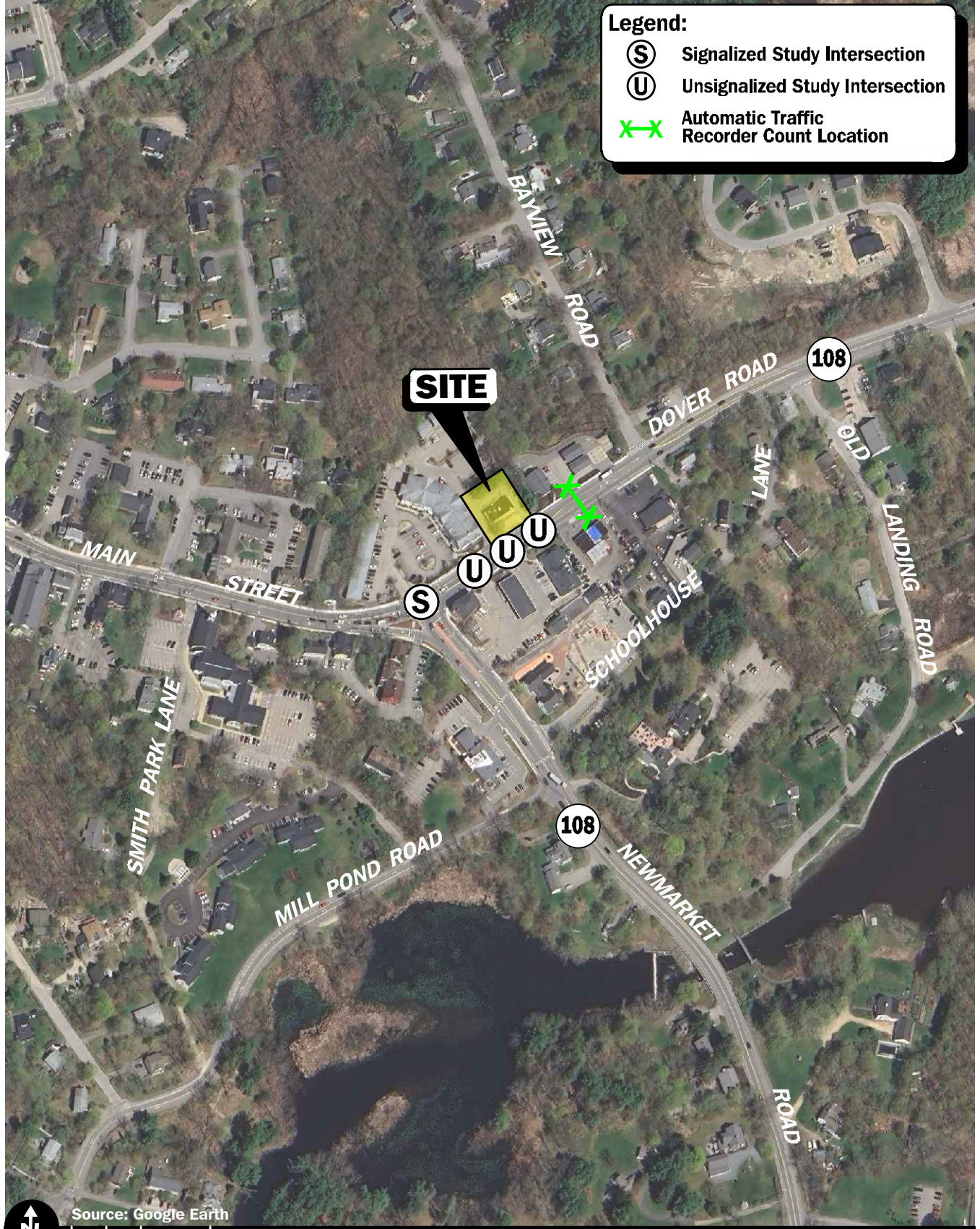

Figure 1

Site Location and Study Area Map



Legend:

- Ⓢ Signalized Intersection
- Ⓤ Unsignalized Intersection
- Sidewalk
- Crosswalk
- xx'↔ Lane Use and Travel Lane Width
- *xx'↪ Channelized Right-Turn Movement

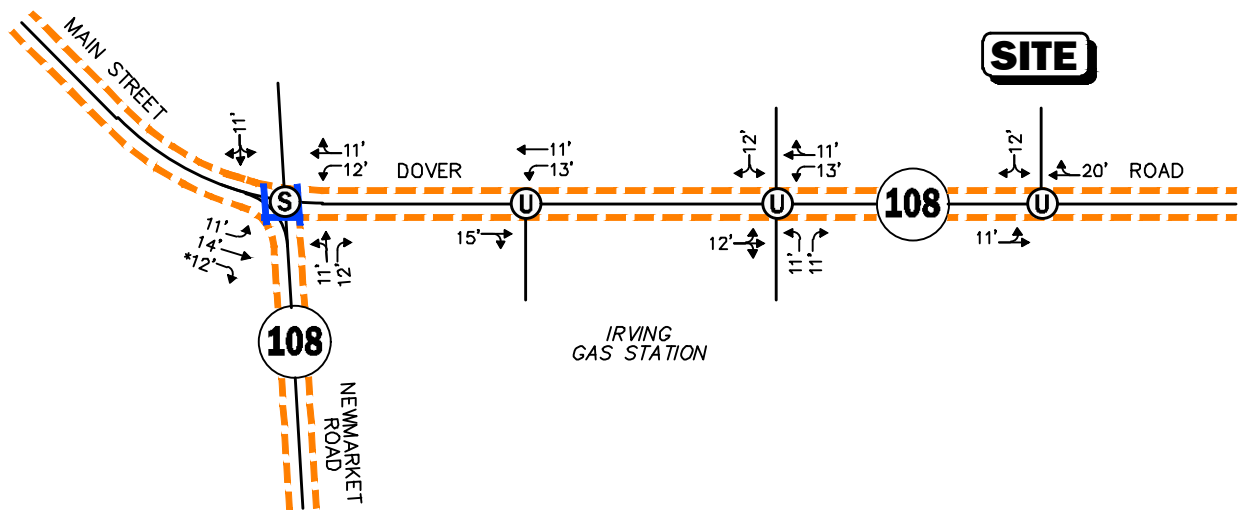

 Not To Scale



Figure 2
Existing Intersection Lane Use, Travel Lane Width, and Pedestrian Facilities

R:\10078\Graphics\TIA\December 2024\10078NT1.dwg, 1/7/2025 2:13:03 PM

EXISTING TRAFFIC VOLUMES

In order to establish existing traffic-volume conditions within the study area, manual turning movement counts (TMCs) were completed in October and November 2024. The TMCs were conducted during the weekday morning (7:00 to 9:00 AM), weekday evening (4:00 to 6:00 PM), and Saturday midday (11:00 AM to 2:00 PM) peak periods. An automatic traffic recorder count (ATR) was conducted in October and November 2024 east of the Project site driveway for 72 hours (Thursday through Saturday).

Traffic-Volume Adjustments

In order to develop 2024 Existing traffic-volume conditions, the data collected required review to determine if adjustments due to the effects of the COVID-19 pandemic were necessary. To achieve this, count data from the NHDOT permanent count station ID 02133021² located on Piscataqua Road (US Route 4) east of NH Route 108 was used. Daily count data from October and November 2019 and 2024 were used to develop COVID-19 correction factors. Based on this evaluation, the 2024 traffic volumes were higher than the 2019 traffic volumes for all periods.

In addition to correction factors for COVID-19, the data collected required review to determine if adjustments to account for seasonal fluctuations in traffic were required. Again, the NHDOT permanent count station ID 02133021 was used to adjust the traffic volumes for seasonal fluctuations. Based on this data, it was determined that October traffic volumes are equal to peak-month conditions and November traffic volumes are approximately 9 percent below peak-month conditions for this station. Therefore, the October traffic volumes were left unadjusted while the November traffic volumes were increased by 9 percent to peak-month conditions for analysis. The 2024 Existing traffic volumes on Dover Road are summarized in Table 1.

**Table 1
2024 EXISTING ROADWAY TRAFFIC-VOLUME SUMMARY**

Location/Peak-Hour	Weekday Daily ^a	Saturday Daily ^b	VPH ^c	K Factor ^d	Directional Distribution ^e
<i>Dover Road, east of Project Site Driveway:</i>	14,650	17,150	--	--	--
Weekday Morning	--	--	1,338	9.1	51.0% EB
Weekday Evening	--	--	1,499	10.2	50.8% EB
Saturday Midday	--	--	1,516	8.8	50.3% EB

^aAverage weekday traffic in vehicles per day, based on ATR data.

^bAverage Saturday traffic in vehicles per day, based on ATR data adjusted for peak-month conditions.

^cVehicles per hour.

^dPercent of daily traffic occurring during the peak hour.

^ePercent traveling in peak direction.

As can be seen in Table 1, Dover Road east of the Project site driveway was found to accommodate approximately 14,650 vehicles on an average weekday (two-way, 24-hour volumes), with approximately 1,338 vehicles per hour (vph) during the weekday morning peak hour and 1,499 vph

²NHDOT Transportation Data Management System; Location ID 02037090; located on F.E. Everett Turnpike at the Bedford Toll Plaza.

during the weekday evening peak hour. On Saturday, Dover Road was found to accommodate 17,150 vpd with 1,516 vph during the Saturday midday peak hour. The 2024 Existing weekday morning, weekday evening, and Saturday midday peak-hour traffic volumes for the study area intersections are graphically depicted on Figure 3.

PEDESTRIAN AND BICYCLE FACILITIES

A comprehensive field inventory of pedestrian and bicycle facilities within the study area was undertaken in November 2024. The field inventory consisted of a review of the location of sidewalks and pedestrian crossing locations along the study area roadways and at the study area intersections, as well as the location of bicycle facilities. Based on this review, it was determined that sidewalk is provided on both sides of Dover Road, Main Street, and Newmarket Road. Crosswalks are provided across the east, west, and south legs of the Dover Road/Main Street at Newmarket Road/Holiday Inn Express driveway intersection. On Main Street west of Newmarket Road, the shoulders of the roadway have pavement markings indicating the road is to be shared with bicyclists.

PUBLIC TRANSPORTATION SERVICES

Public transportation services are provided within the study area by the University of New Hampshire (UNH) for fixed-route bus services. Table 2 summarizes the characteristics of these services. It should be noted that there is no Sunday service provided. Schedules and fare information for the services are provided in the Appendix.

**Table 2
PUBLIC TRANSPORTATION SERVICES**

Service	Stop Closest to Project Site	Distance from Project Site	Weekday		Saturday	
			Hours of Operation	Headway (minutes)	Hours of Operation	Headway (minutes)
UNH Bus: Route 3: Durham – Dover	Dover Road at Young Drive	~ 750 feet east	6:40 AM – 10:33 PM	65-210	10:05 AM – 9:03 PM	240-300
UNH Bus: Route 4: Durham – Malls/ Portsmouth Market Square	Dover Road at Young Drive	~ 750 feet east	6:40 AM – 10:49 PM	65-269	11:35 AM – 10:33 PM	90-270

MOTOR VEHICLE CRASH DATA

Motor vehicle crash data for the study area intersections has been requested from the Durham Police Department in order to examine motor vehicle crash trends occurring within the study area. Once the data is received, it will be summarized in a supplemental memorandum.

WEEKDAY MORNING PEAK HOUR

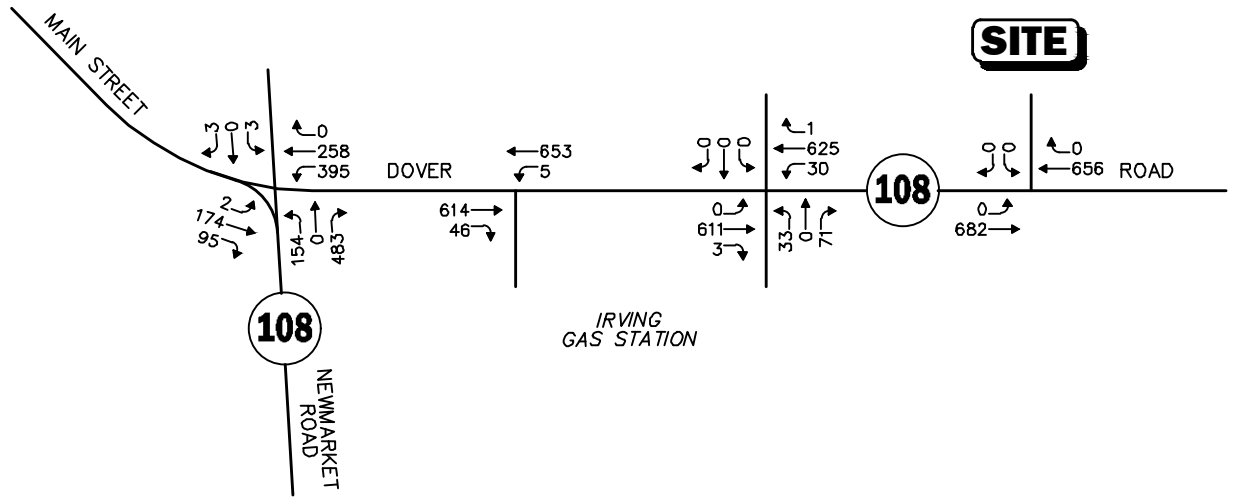

WEEKDAY EVENING PEAK HOUR

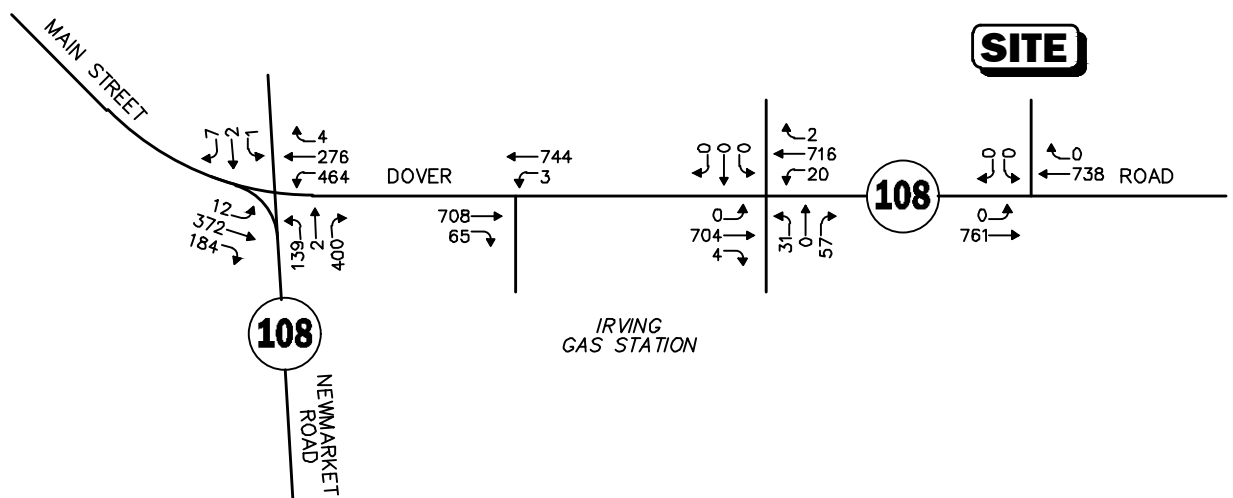

SATURDAY MIDDAY PEAK HOUR

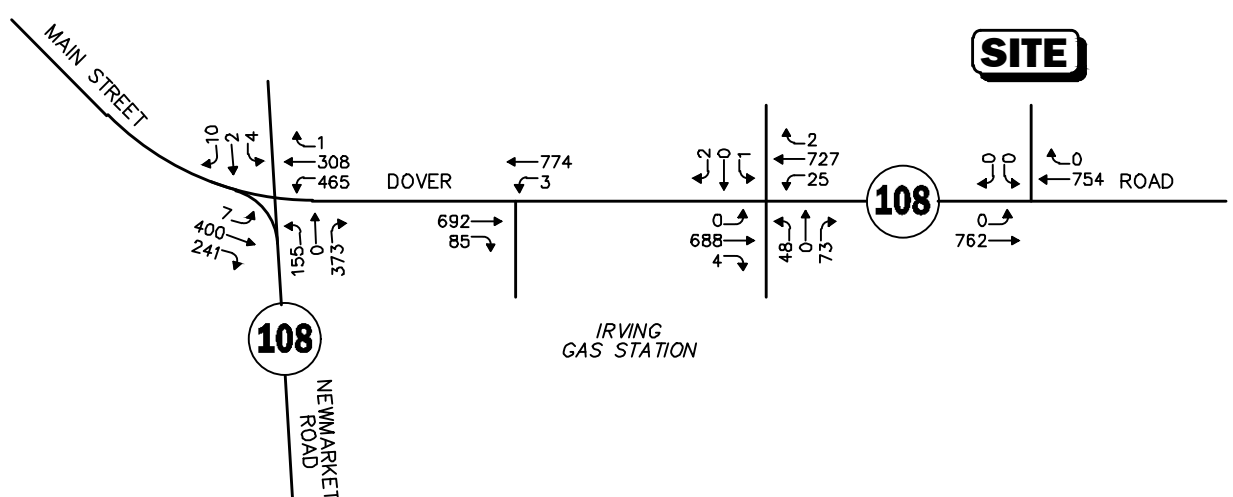

Not To Scale Figure 3



2024 Existing Peak-Hour Traffic Volumes

R:\10078\Graphics\TIA\December 2024\10078NT1.dwg, 1/7/2025 2:13:12 PM

VEHICLE SPEED MEASUREMENTS

Existing vehicle speeds along Dover Road east of the Project site driveway were recorded in conjunction with the ATR to determine the average and 85th percentile vehicle speeds. The 85th percentile speed is used as the basis of engineering design and in the evaluation of sight distances and is often used in establishing posted speed limits. The speed limit on Dover Road in the area of the Project site is posted at 25 mph eastbound and 30 mph westbound. The results of the speed measurements are shown in Table 3.

Table 3
VEHICLE TRAVEL SPEED MEASUREMENTS

	Dover Road	
	Eastbound	Westbound
Speed Limit (mph)	25	30
Average Travel Speed (mph)	30	25
85 th Percentile Speed (mph)	33	30

mph = miles per hour.

As can be seen in Table 3, the average travel speed along Dover Road in the vicinity of the Project site was found to be 25 mph westbound and 30 mph eastbound. The measured 85th percentile travel speed was found to be 30 mph westbound and 33 mph eastbound.

FUTURE CONDITIONS

To determine the impact of site-generated traffic volumes on the roadway network under future conditions, baseline traffic volumes in the study area were projected to the years 2025 and 2035. Traffic volumes on the roadway network at that time, in the absence of the Project (that is, the No-Build condition), would include existing traffic, new traffic due to general background traffic growth, and traffic related to specific development by others expected to be completed by 2025 and 2035. Inclusion of these factors resulted in the development of 2025 and 2035 No-Build traffic volumes. Anticipated site-generated traffic volumes were then superimposed upon these No-Build traffic-flow networks to develop the 2025 Opening-Year and 2035 Design-Year Build traffic-volume conditions.

FUTURE TRAFFIC GROWTH

Traffic growth on area roadways is a function of the expected land development impacting the study area. Several methods are used to estimate this growth. A procedure frequently employed estimates an annual percentage increase in traffic growth and applies that percentage to all existing traffic volumes under study. The drawback to such a procedure is that some turning volumes may actually grow at either a higher or a lower rate at particular intersections.

In addition, we identified the location and type of planned development affecting the study area, estimated the traffic to be generated by that development, and assigned it to the area roadway network. This produces a more realistic estimate of growth for local traffic. However, the drawback of this procedure is that the potential growth in population and development external to the study area would not be accounted for in the traffic projections.

To provide a conservative analysis framework, both procedures were used in this TIS.

General Background Growth

Traffic-volume data compiled by NHDOT from a permanent count station 02133021 was reviewed in order to determine general traffic growth trends in the study area. This data indicates that traffic volumes have decreased over the 10-year period between 2009 and 2019, with an average decrease of -0.58 percent. To be conservative and consistent with NHDOT standards, a 1 percent per year compounded annual background traffic growth rate was used in order to account for future traffic growth and presently unforeseen development within the study area.

Specific Development by Others

The Town of Durham was contacted in order to determine if there are any projects planned within the study area that would have an impact on future traffic volumes at the study intersections. Based on these discussions there are no projects planned within the study area at this time.

Planned Roadway Improvements

NHDOT and the Strafford Regional Planning Commission were contacted in order to determine if there were any planned future roadway improvement projects within the study area. Based on these discussions, no roadway improvement projects aside from routine maintenance activities were identified to be planned within the study area at this time.

No-Build Traffic Volumes

The 2025 and 2035 No-Build peak-month peak-hour traffic-volume networks were developed by applying the 1.0 percent per year compounded annual background traffic growth rate to the 2024 Existing peak-hour traffic volumes and incorporating the above background development traffic volumes. The resulting 2025 and 2035 No-Build weekday morning, weekday evening, and Saturday midday peak-hour traffic volumes are graphically depicted on Figure 4 and Figure 5, respectively.

PROJECT-GENERATED TRAFFIC

The Project entails relocation and expansion of a 1,100-sf Dunkin' coffee shop without a drive-through window to a 1,500-sf Dunkin' coffee shop without a drive-through window. The existing Dunkin' coffee shop is located within the Irving gas station building. As this Dunkin' is relocating across Dover Road, the trips generated by the existing Dunkin' were not considered new trips to the area while the new trips generated by the expansion were considered new. To develop the traffic characteristics of the existing Dunkin', weekday morning (7:00 to 9:00 AM) and weekday evening (3:00 to 6:00 PM) peak period doorway counts were conducted. All patrons of the Dunkin' coffee shop were counted in order to develop peak-hour trips for the existing facility and develop trip rates to be applied to the new facility. Using this data in conjunction with the Institute of Transportation Engineers (ITE)³ data for Land Use Code (LUC) 936, *Coffee/Donut Shop without Drive-Through Window*, empirical Saturday peak-hour trip rates were developed. Weekday daily and Saturday daily trips for the existing facility were estimated using ITE.

Pass-By Trips

Deductions in the base trip-generation calculations can be made to account for pass-by trips. Pass-by trips are drivers already traveling along adjacent roadways for purposes other than visiting the Dunkin' coffee shop in conjunction with their trip and then continuing to their original destination. LUC 938, *Coffee/Donut Shop with Drive-Through Window and No Indoor Seating*, reports that a percentage of the total vehicle trips to the site should be considered as existing vehicle trips or vehicles that were already passing by the site. These pass-by vehicle trips are not considered to be generated by the site, so they are removed. LUC 938 was used in place of LUC 936 as ITE does not have pass-by data for LUC 936. A conservative estimate of 80 percent was used for this assessment.

³*Trip Generation*, 11th Edition; Institute of Transportation Engineers; Washington, DC; 2021.

WEEKDAY MORNING PEAK HOUR

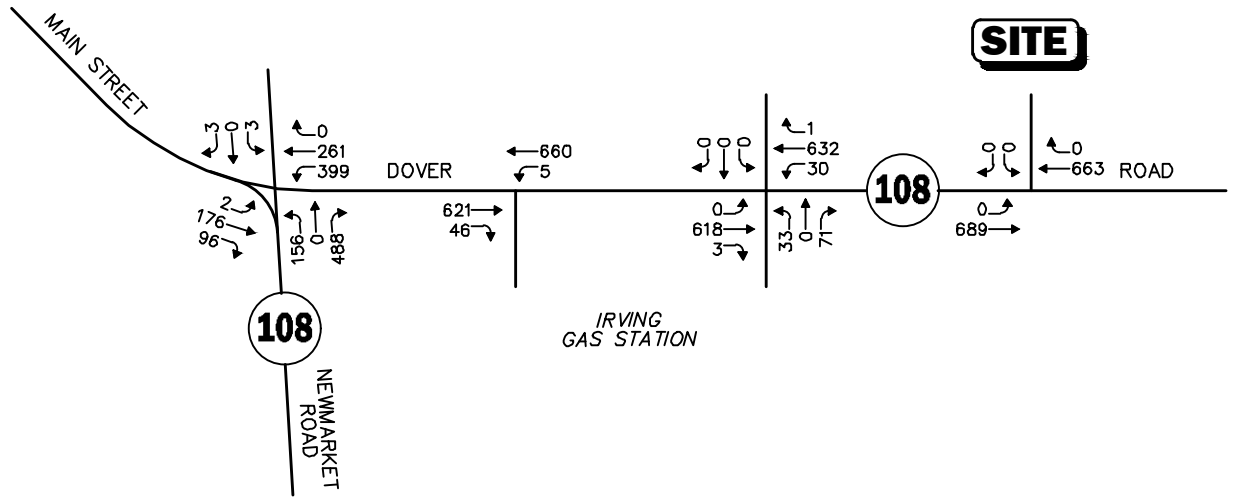

WEEKDAY EVENING PEAK HOUR

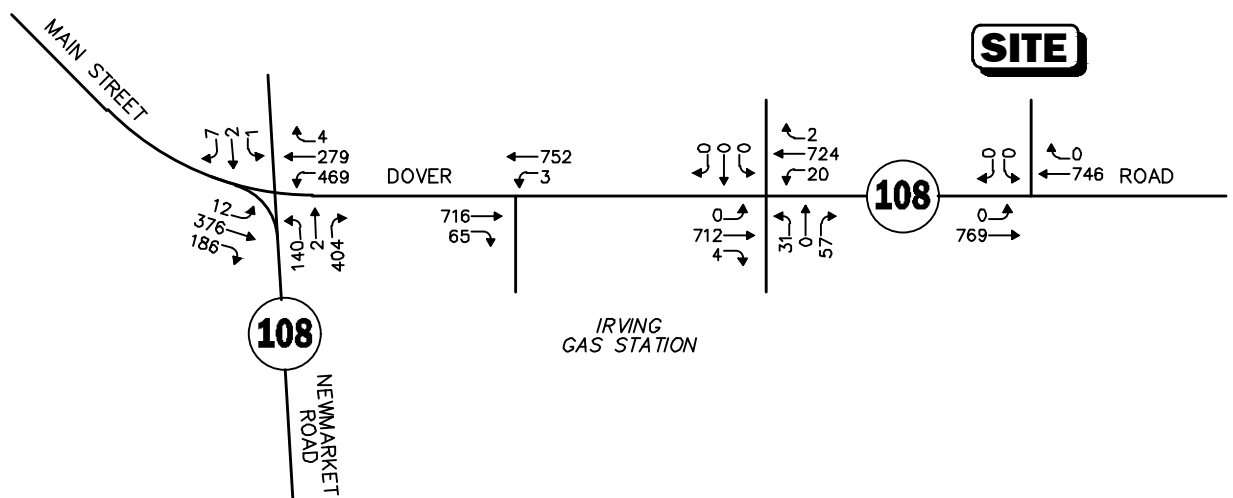

SATURDAY MIDDAY PEAK HOUR

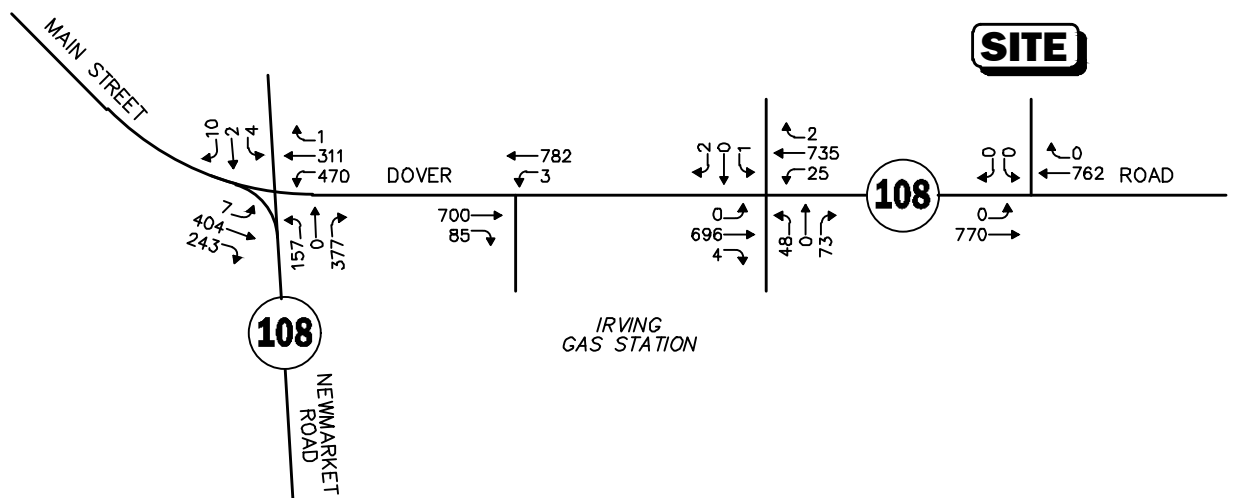

Not To Scale Figure 4



2025 Opening-Year No-Build Peak-Hour Traffic Volumes

R:\10078\Graphics\TIA\December 2024\10078NT1.dwg, 1/7/2025 2:13:21 PM

WEEKDAY MORNING PEAK HOUR

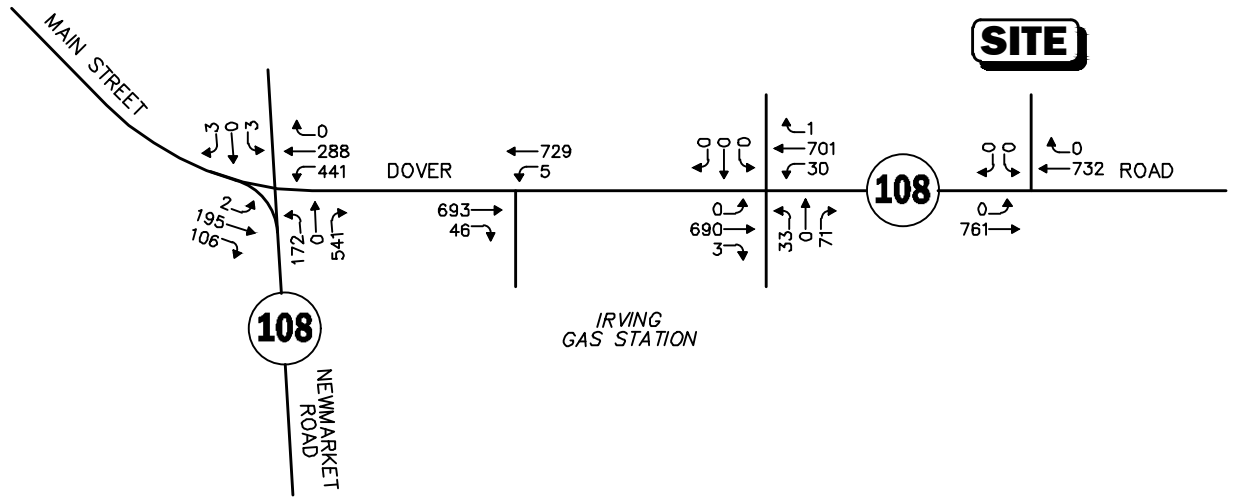

WEEKDAY EVENING PEAK HOUR

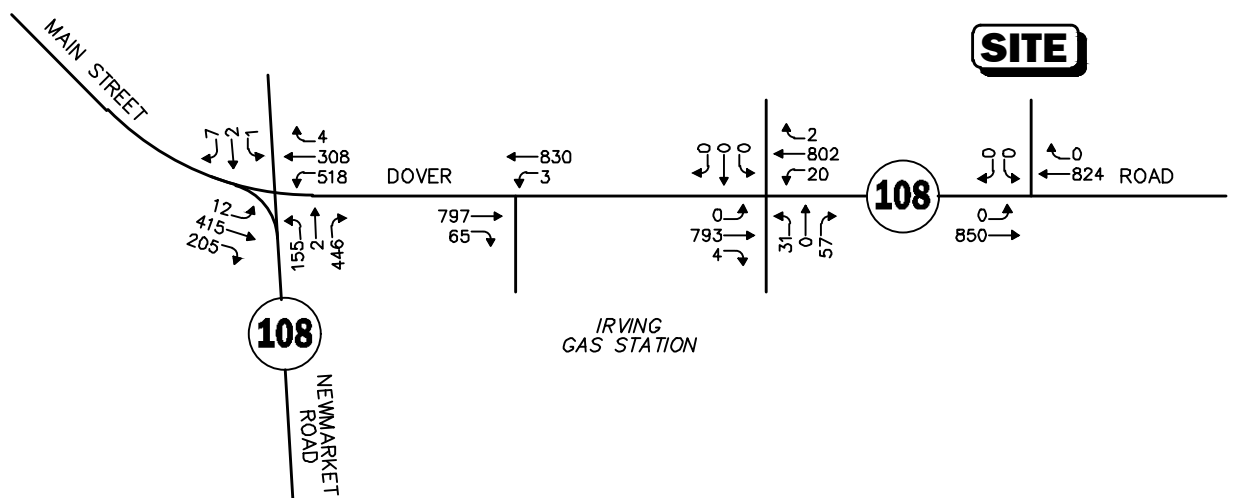

SATURDAY MIDDAY PEAK HOUR

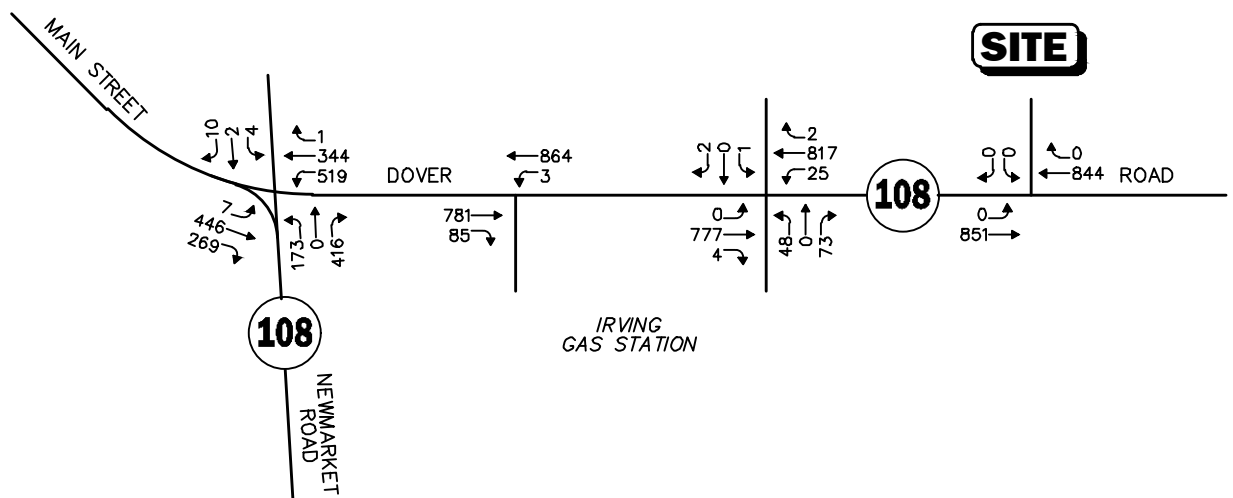

 Not To Scale

Figure 5

2035 Design-Year No-Build Peak-Hour Traffic Volumes



A summary of the existing Dunkin’ trip generation is provided in Table 4.

**Table 4
EXISTING TRIP GENERATION SUMMARY**

Time Period/Direction	Existing Trips	Empirical Trip Rates (Trips/1,000 sf)	Pass-by Trips ^d	New Trips
Weekday Daily	636 ^a	--	508	128
<i>Weekday Morning Peak Hour:</i>				
Entering	61	55.45	54	7
<u>Exiting</u>	<u>73</u>	<u>66.36</u>	<u>54</u>	<u>19</u>
Total	134 ^b	121.81	108	26
<i>Weekday Evening Peak Hour:</i>				
Entering	26	23.64	22	4
<u>Exiting</u>	<u>29</u>	<u>26.36</u>	<u>22</u>	<u>7</u>
Total	55 ^b	50.00	44	11
Saturday Daily	694 ^a	--	556	138
<i>Saturday Midday Peak Hour:</i>				
Entering	40	36.36	32	8
<u>Exiting</u>	<u>41</u>	<u>37.27</u>	<u>32</u>	<u>9</u>
Total	81 ^c	73.63	64	17

^aBased on ITE LUC 936, *Coffee/Donut Shop without Drive-Through Window*; 1,100 sf.

^bBased on observations by VAI in December 2024.

^cBased on ITE LUC 936, *Coffee/Donut Shop without Drive-Through Window*; 1,100 sf. Then adjusted using the observed weekday morning trips multiplied by ITE LUC 936 weekday morning trips divided by ITE LUC 936 Saturday midday trips.

^dPass-By Trips based on ITE LUC 938, *Coffee/Donut Shop with Drive-Through Window and No Indoor Seating*; 80 percent.

As shown in Table 4, the existing Dunkin’ coffee shop is estimated to generate 636 vehicle trips on an average weekday (two-way, 24-hour volume). A total of 134 trips (61 entering and 73 exiting) were observed during the weekday morning peak hour and 55 trips (26 entering and 29 exiting) were observed during the weekday evening peak hour. On a Saturday, the Project is estimated to generate 694 vehicle trips with 81 vehicle trips (40 entering and 41 exiting) during the Saturday midday peak hour.

In order to develop the traffic characteristics of the proposed Dunkin’ coffee shop, LUC 936, *Coffee/Donut Shop without Drive-Through* was used in conjunction with the trip rates from Table 4. Table 5 summarizes the trip generation of the proposed Dunkin’.

Table 5
PROPOSED TRIP GENERATION SUMMARY

Time Period/Direction	Empirical Trip Rates ^a	Proposed Total Trips	Pass-by Trips ^d	New Trips
Weekday Daily	--	868 ^b	694	174
<i>Weekday Morning Peak Hour:</i>				
Entering	55.45	83	73	10
<u>Exiting</u>	<u>66.36</u>	<u>100</u>	<u>73</u>	<u>27</u>
Total	121.81	183 ^c	146	37
<i>Weekday Evening Peak Hour:</i>				
Entering	23.64	35	30	5
<u>Exiting</u>	<u>26.36</u>	<u>40</u>	<u>30</u>	<u>10</u>
Total	50.00	75 ^c	60	15
Saturday Daily	--	946 ^b	756	190
<i>Saturday Midday Peak Hour:</i>				
Entering	36.36	55	44	11
<u>Exiting</u>	<u>37.27</u>	<u>56</u>	<u>44</u>	<u>12</u>
Total	73.63	111 ^c	88	23

^aFrom Table 4.

^bBased on ITE LUC 936, *Coffee/Donut Shop without Drive-Through Window*; 1,500 sf.

^cBased on trip rates multiplied by 1.5 ksf.

^dPass-By Trips based on ITE LUC 938, *Coffee/Donut Shop with Drive-Through Window and No Indoor Seating*; 80 percent.

As shown in Table 5, the Project is expected to generate 868 vehicle trips on an average weekday with 183 vehicle trips (83 entering and 100 exiting) during the weekday morning peak hour and 75 vehicle trips (35 entering and 40 exiting) during the weekday evening peak hour. On a Saturday, the Project is expected to generate 946 vehicle trips with 111 vehicle trips (55 entering and 56 exiting) during the Saturday midday peak hour.

In order to determine the new trips generated by the expansion of the Dunkin' coffee shop from 1,100 sf to 1,500 sf, the trips from Table 4 were subtracted from Table 5 as shown in Table 6.

Table 6
NET NEW TRIP GENERATION SUMMARY

Time Period/Direction	Proposed ^a			Existing ^b			Net New		
	Total Trips	Pass-by Trips	New Trips	Total Trips	Pass-by Trips	New Trips	Total Trips	Pass-by Trips	New Trips
Weekday Daily	868	694	174	636	508	128	232	186	46
<i>Weekday Morning Peak Hour:</i>									
Entering	83	73	10	61	54	7	22	19	3
Exiting	<u>100</u>	<u>73</u>	<u>27</u>	<u>73</u>	<u>54</u>	<u>19</u>	<u>27</u>	<u>19</u>	<u>8</u>
Total	183	146	37	134	108	26	49	38	11
<i>Weekday Evening Peak Hour:</i>									
Entering	35	30	5	26	22	4	9	8	1
Exiting	<u>40</u>	<u>30</u>	<u>10</u>	<u>29</u>	<u>22</u>	<u>7</u>	<u>11</u>	<u>8</u>	<u>3</u>
Total	75	60	15	55	44	11	20	16	4
Saturday Daily	946	756	190	694	556	138	252	200	52
<i>Saturday Midday Peak Hour:</i>									
Entering	55	44	11	40	32	8	15	12	3
Exiting	<u>56</u>	<u>44</u>	<u>12</u>	<u>41</u>	<u>32</u>	<u>9</u>	<u>15</u>	<u>12</u>	<u>3</u>
Total	111	88	23	81	64	17	30	24	6

^aFrom Table 5.

^bFrom Table 4.

As shown in Table 6, the Project is expected to generate 232 additional vehicle trips on an average weekday with 49 additional vehicle trips (22 entering and 27 exiting) during the weekday morning peak hour and 20 additional vehicle trips (9 entering and 11 exiting) during the weekday evening peak hour. On Saturday, the Project is expected to generate 252 additional vehicle trips with 30 additional vehicle trips (15 entering and 15 exiting) during the Saturday midday peak hour.

TRIP DISTRIBUTION AND ASSIGNMENT

The directional distribution of the site-generated trips to and from the Project was developed based on a review of existing travel patterns throughout the study area. The trip distribution for the Project is summarized in Table 7 and graphically depicted in Figure 6. The existing Dunkin’ trips were redistributed to the Project site as shown on Figure 7 while the proposed Project trips due to the expansion of the facility were assigned to the roadway network as shown on Figure 8.

**Table 7
TRIP-DISTRIBUTION SUMMARY**

Roadway	Direction (To/From)	Percent (To/From)
Dover Road	East	40
Main Street	West	25
Newmarket Road	South	<u>35</u>
TOTAL		100

FUTURE TRAFFIC VOLUMES – BUILD CONDITION

The 2025 Opening-Year Build condition networks consist of the 2025 Opening-Year No-Build traffic volumes with the anticipated Project-generated traffic added to them. The 2025 Opening-Year Build weekday morning, weekday evening, and Saturday midday peak-hour traffic-volume networks are graphically depicted on Figure 9.

The 2035 Design-Year Build condition networks consist of the 2035 Design-Year No-Build traffic volumes with the anticipated Project-generated traffic added to them. The 2035 Design-Year Build weekday morning, weekday evening, and Saturday midday peak-hour traffic-volume networks are graphically depicted on Figure 10.

A summary of peak-month peak-hour projected traffic-volume increases external to the study area that is the subject of this assessment is shown in Table 8. These volumes are based on the expected increases from the Project.

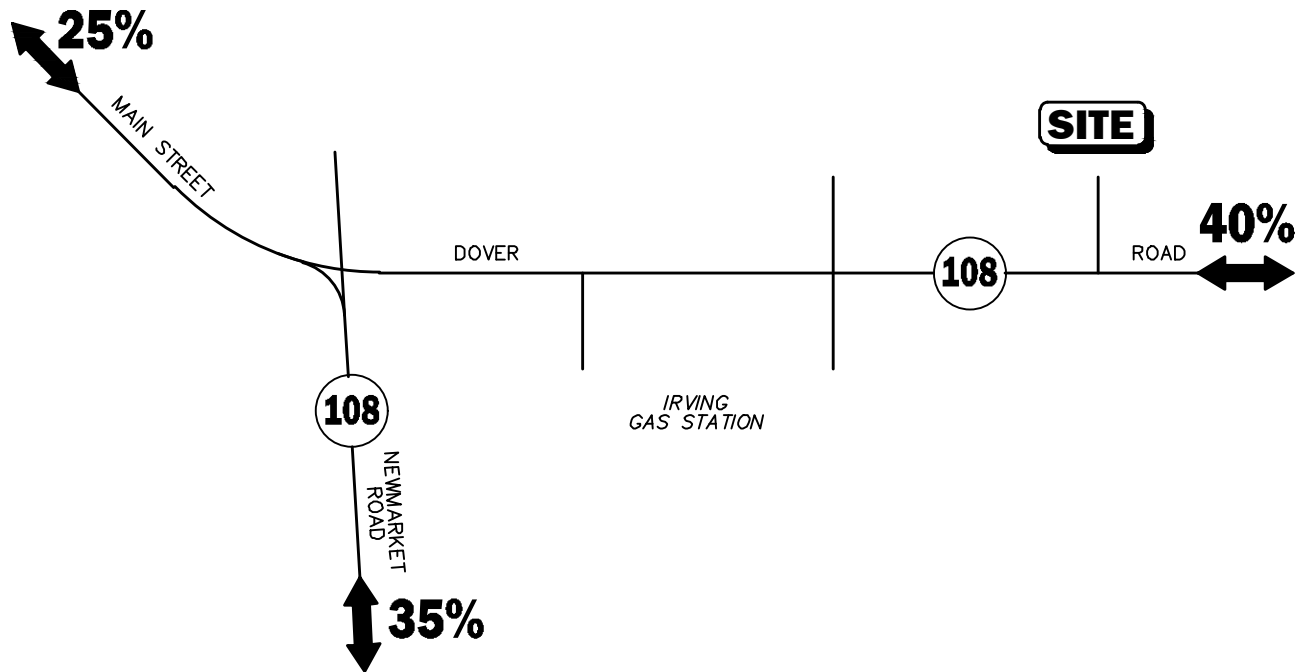

Not To Scale

Figure 6

Trip Distribution Map



WEEKDAY MORNING PEAK HOUR

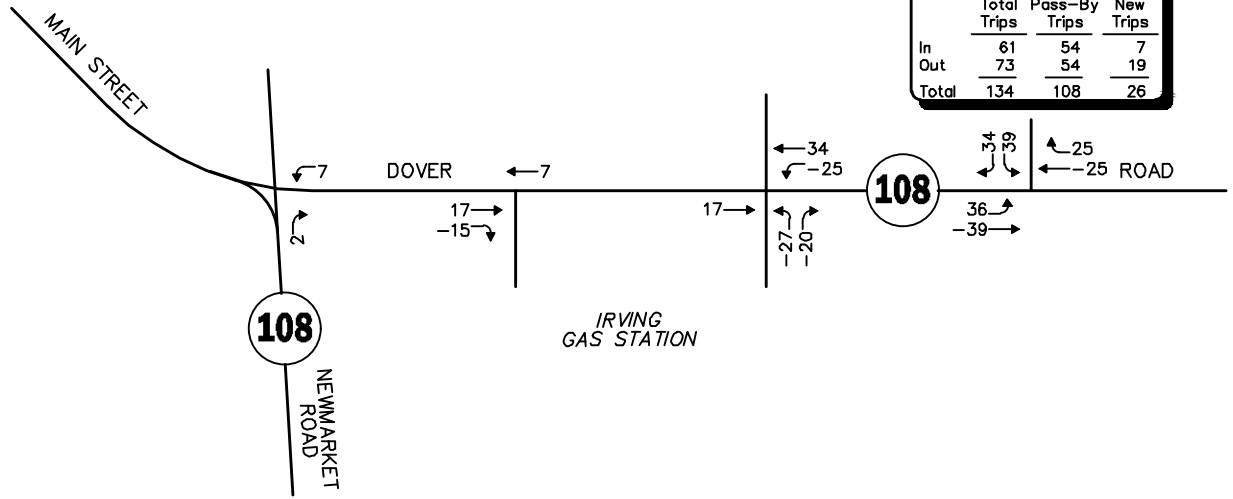

WEEKDAY EVENING PEAK HOUR

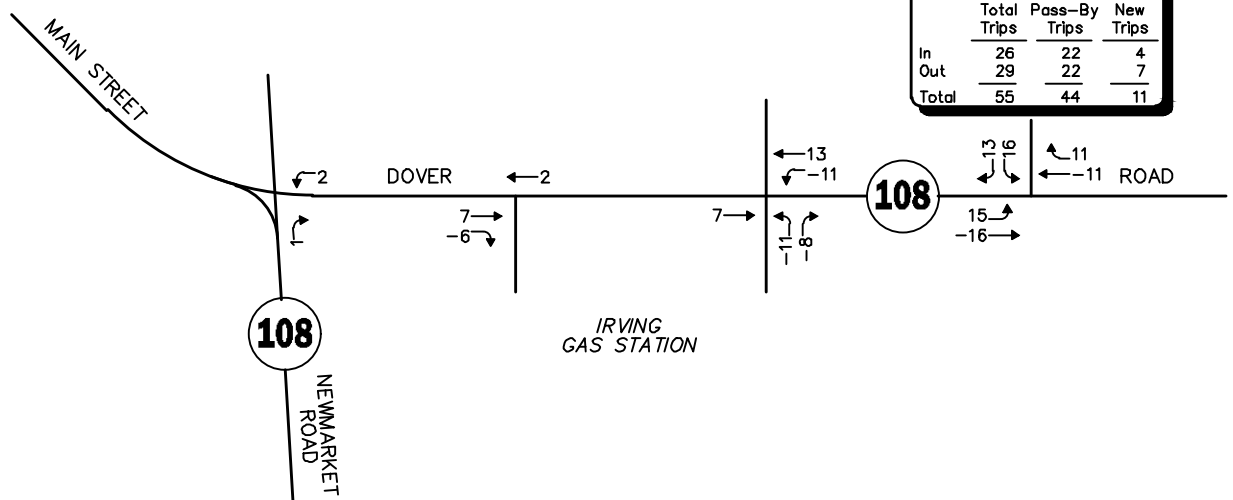

SATURDAY MIDDAY PEAK HOUR

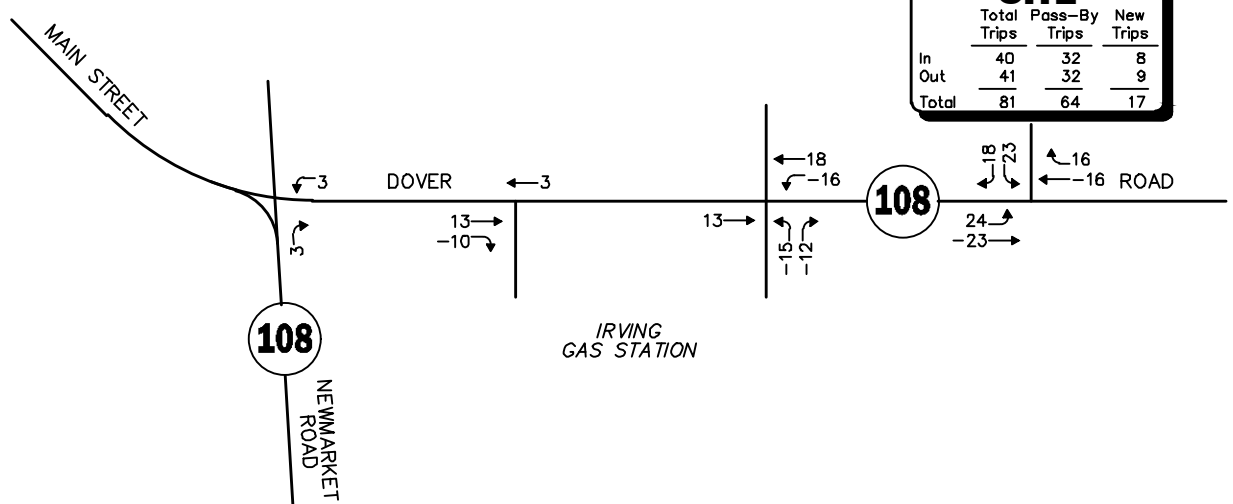

 Not To Scale

Figure 7

**Existing Dunkin' Trips
Redistributed**



WEEKDAY MORNING PEAK HOUR

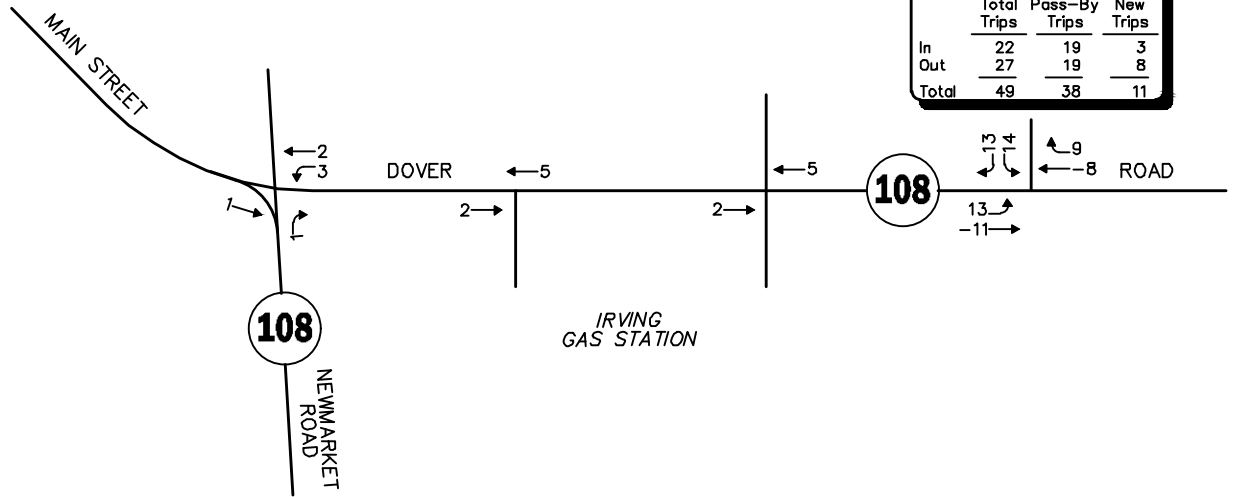

WEEKDAY EVENING PEAK HOUR

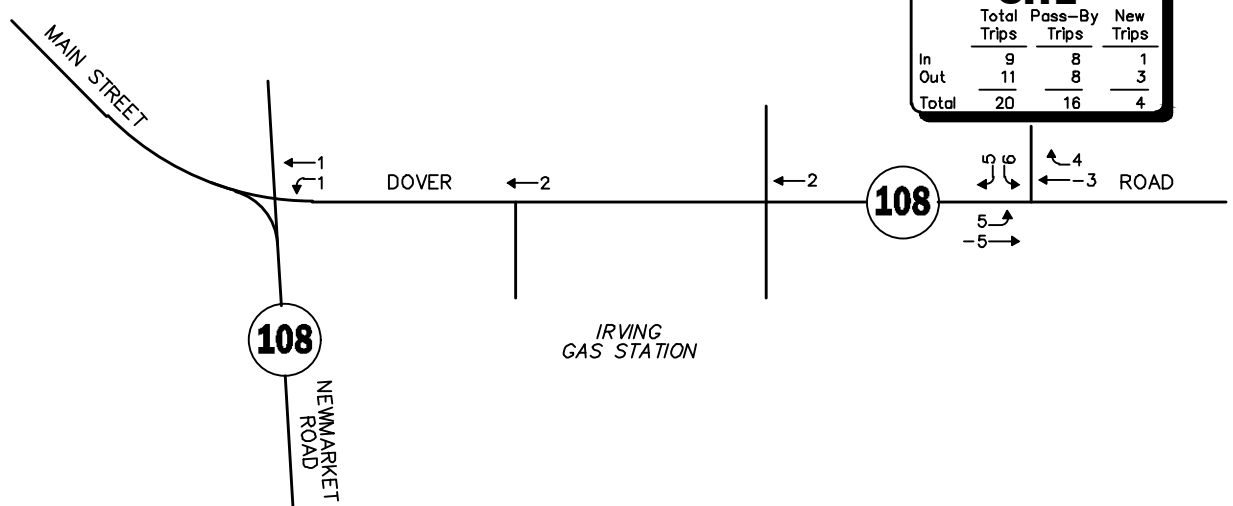

SATURDAY MIDDAY PEAK HOUR

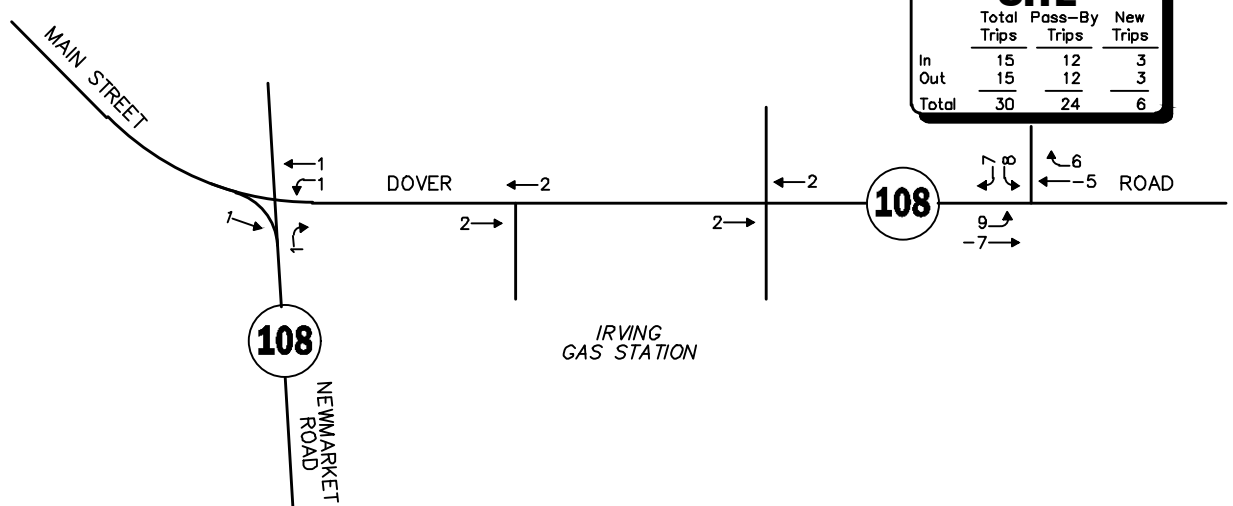

Not To Scale **Figure 8**



Proposed Dunkin' Trips Due to Expansion

R:\10078\Graphics\TIA\December 2024\10078NT1.dwg, 1/7/2025 2:13:51 PM

WEEKDAY MORNING PEAK HOUR

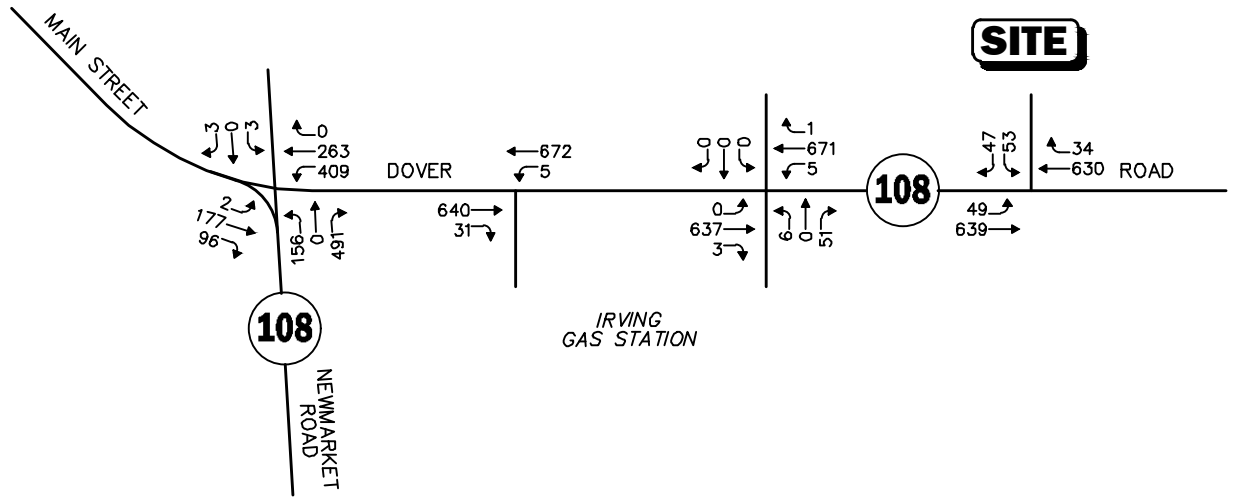

WEEKDAY EVENING PEAK HOUR

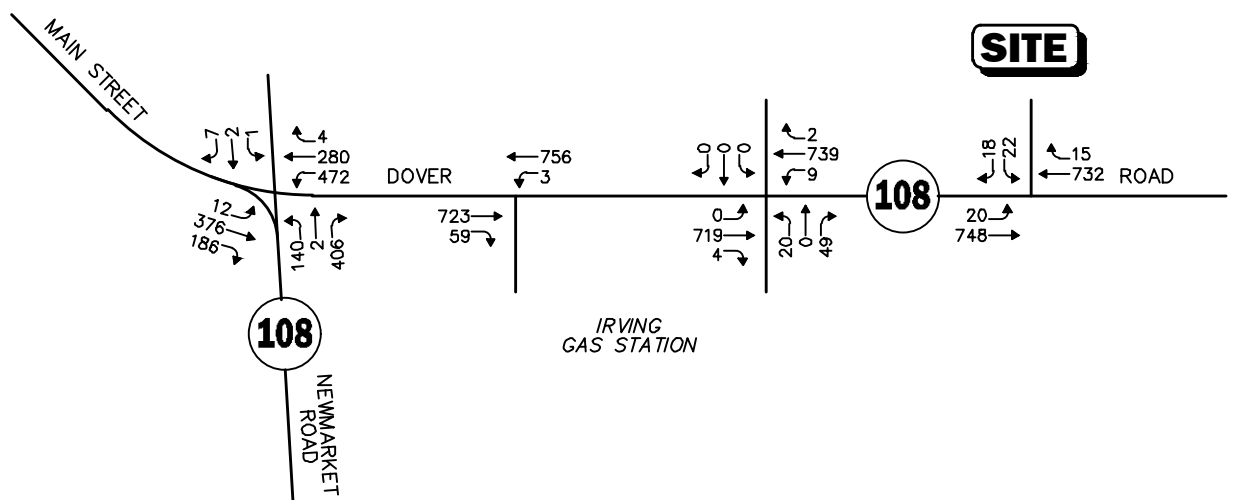

SATURDAY MIDDAY PEAK HOUR

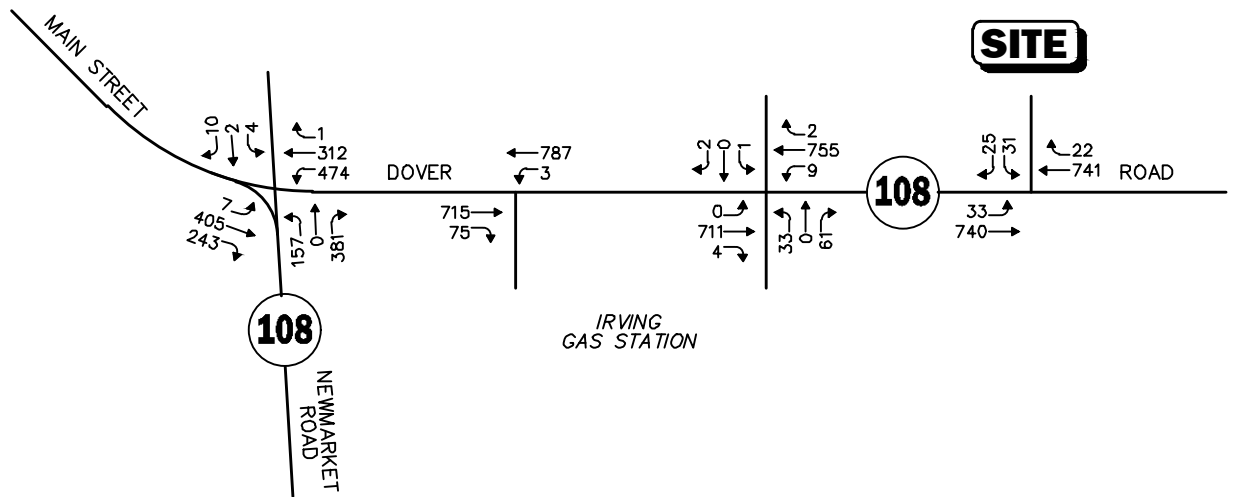

Not To Scale Figure 9



2025 Opening-Year Build Peak-Hour Traffic Volumes

R:\10078\Graphics\TIA\December 2024\10078NT1.dwg, 1/7/2025 2:13:59 PM

WEEKDAY MORNING PEAK HOUR

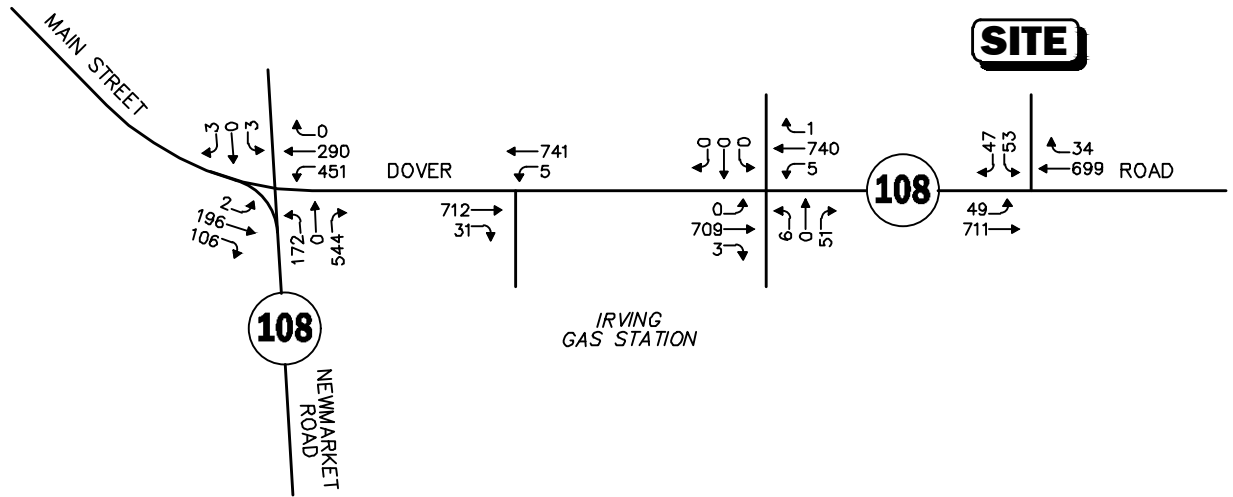

WEEKDAY EVENING PEAK HOUR

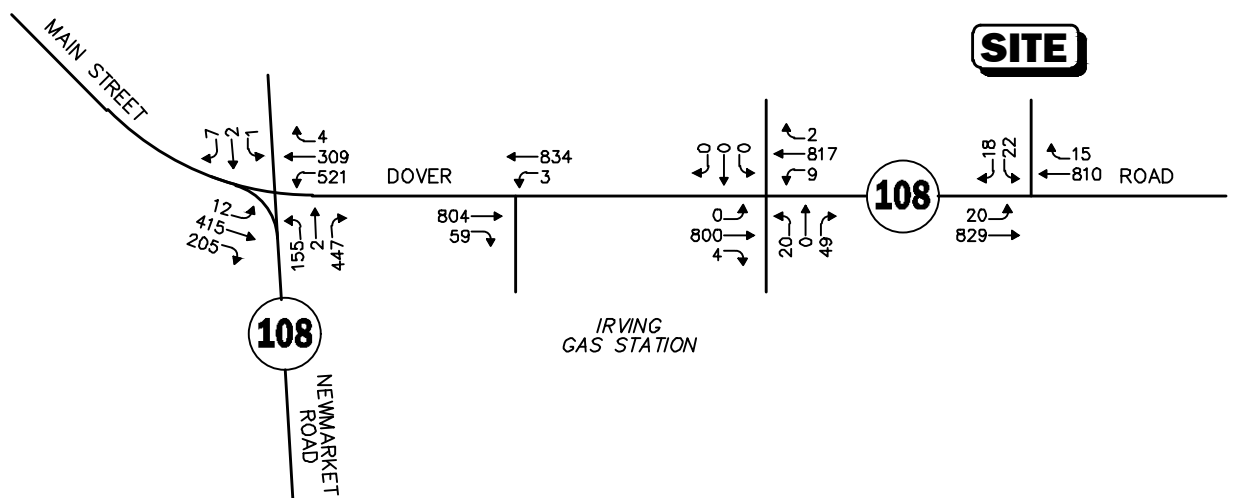

SATURDAY MIDDAY PEAK HOUR

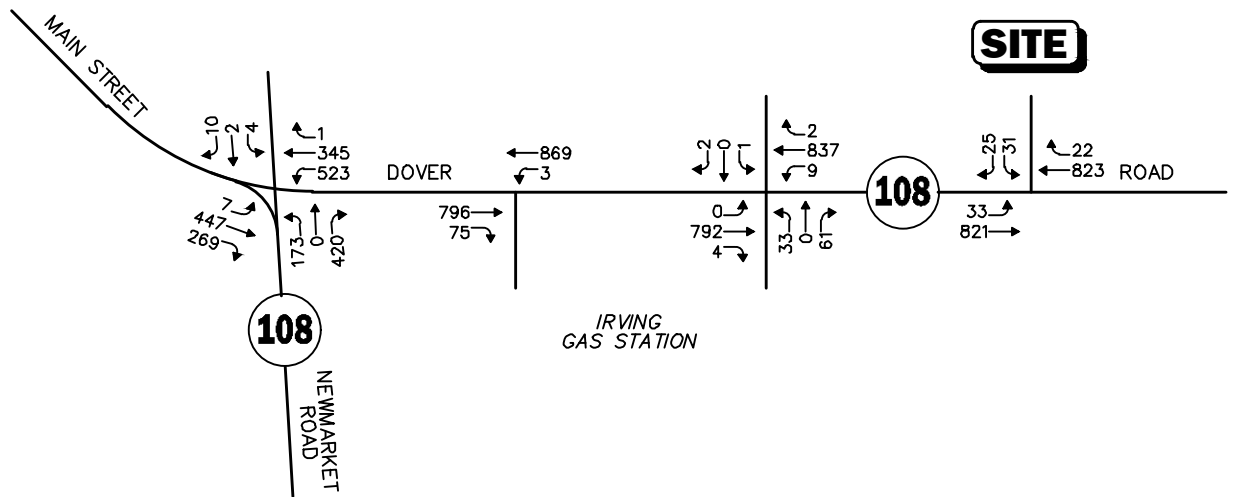

Not To Scale Figure 10



2035 Design-Year Build Peak-Hour Traffic Volumes

R:\10078\Graphics\TIA\December 2024\10078NT1.dwg, 1/7/2025 2:14:08 PM

Table 8
PEAK-MONTH PEAK-HOUR TRAFFIC-VOLUME INCREASES

Location/Peak Hour	2025/2035 No-Build	2025/2035 Build	Traffic-Volume Change Over No-Build	Percent Change Over No-Build
<i>Main Street, west of Newmarket Road:</i>				
Weekday Morning	694/766	697/769	3/3	0.4/0.4
Weekday Evening	1,000/1,102	1,001/1,103	1/1	0.1/0.1
Saturday MIDDAY	1,132/1,249	1,134/1,251	2/2	0.2/0.2
<i>Newmarket Road, south of Dover Road:</i>				
Weekday Morning	1,139/1,260	1,152/1,273	13/13	1.1/1.0
Weekday Evening	1,203/1,328	1,207/1,332	4/4	0.3/0.3
Saturday MIDDAY	1,249/1,379	1,257/1,387	8/8	0.6/0.6
<i>Dover Road, east of Project Site Driveway:</i>				
Weekday Morning	1,352/1,493	1,356/1,497	4/4	0.3/0.3
Weekday Evening	1,515/1,674	1,517/1,676	2/2	0.1/0.1
Saturday MIDDAY	1,532/1,695	1,534/1,697	2/2	0.1/0.1

As shown in Table 8, Project-related traffic-volume increases external to the study area relative to 2025 and 2035 No-Build conditions are anticipated to range from 1 to 13 vehicles or 0.1 to 1.1 percent during the peak periods.

TURN LANE WARRANT ANALYSES

An auxiliary turn lane (left- and right-turn lanes) warrants analysis was conducted for the Dover Road approaches to the Project site driveway in accordance with the methodology and procedures outlined in the National Cooperative Highway Research Program (NCHRP) Report 457 published by the NCHRP. This analysis was based on one travel lane per direction on Dover Road and using an 85th percentile vehicle travel speed of 30 mph westbound and 33 mph eastbound. Based on this evaluation it was determined that a left-turn lane is warranted under 2025 Opening-Year Build and 2035 Design-Year Build conditions. A right-turn lane was not warranted under 2025 Opening-Year Build or 2035 Design-Year Build conditions. Although a left-turn lane is warranted, there is not enough width on Dover Road to construct an eastbound left-turn lane. As such, future condition analysis was conducted assuming no eastbound left-turn lane on Dover Road.

SIGHT DISTANCE EVALUATION

Sight distance measurements were performed at the site driveway intersection with Dover Road in accordance with NHDOT and the American Association of State Highway and Transportation Officials (AASHTO)⁴ recommendations. Both stopping sight distance (SSD) and intersection sight distance (ISD) measurements were performed. In brief, SSD is the distance recommended to be provided by a vehicle traveling at the design speed of a roadway, on wet pavement, to stop prior to striking an object in its travel path. ISD is the sight distance recommended to be provided by a driver entering or crossing an intersecting roadway to perceive an on-coming vehicle and safely complete a turning or crossing maneuver with on-coming traffic. Table 9 presents the measured SSD and ISD at the subject intersection.

⁴*A Policy on Geometric Design of Highway and Streets*, 7th Edition; American Association of State Highway and Transportation Officials (AASHTO); Washington D.C.; 2018.

Table 9
SIGHT DISTANCE MEASUREMENTS^a

Intersection/Sight Distance Measurement	Feet		
	Recommended Minimum (SSD)	Desirable (ISD) ^b	Measured
<i>Dover Road at Site Driveway</i>			
<i>Stopping Sight Distance:</i>			
Dover Road approaching from the west	226	--	469
Dover Road approaching from the east	200	--	500+
<i>Intersection Sight Distance:</i>			
Left turn from Site Driveway (looking east)	200	335	500+
Left turn from Site Driveway (looking west)	226	389	411
<i>All Season Safe Sight Distance:</i>			
Left turn from Site Driveway (looking east)	400	--	500+
Left turn from Site Driveway (looking west)	400	--	409

^aRecommended minimum values obtained from *A Policy on Geometric Design of Highways and Streets*, 7th Edition; American Association of State Highway and Transportation Officials (AASHTO); 2018; and based on an approach speed of 33 mph eastbound and 30 mph westbound.

^bValues shown are the intersection sight distance for a vehicle turning left exiting a roadway under STOP control such that motorists approaching the intersection on the major street should not need to adjust their travel speed to less than 70 percent of their initial approach speed. The critical gap for left-turn movements exiting the Project site driveway was increased by 0.5 seconds per additional turn lane on Dover Road.

As can be seen in Table 9, the sight distance at the intersection of the Project site driveway with Dover Road was found to exceed the minimum recommended values for SSD, ISD, All Season Safe Sight Distance, and the desirable values for ISD.

TRAFFIC OPERATIONS ANALYSIS

Measuring existing and future traffic volumes quantifies traffic flow within the study area. To assess quality of flow, roadway capacity, and vehicle queue analyses were conducted under Existing, No-Build, and Build traffic-volume conditions. Capacity analyses provide an indication of how well the roadway facilities serve the traffic demands placed upon them, with vehicle queue analyses providing a secondary measure of the operational characteristics of an intersection or section of roadway under study.

METHODOLOGY

Levels of Service

A primary result of capacity analyses is the assignment of level of service to traffic facilities under various traffic-flow conditions.⁵ The concept of level of service is defined as a qualitative measure describing operational conditions within a traffic stream and their perception by motorists and/or passengers. A level-of-service definition provides an index to quality of traffic flow in terms of such factors as speed, travel time, freedom to maneuver, traffic interruptions, comfort, convenience, and safety.

Six levels of service are defined for each type of facility. They are given letter designations from A to F, with level-of-service (LOS) A representing the best-operating conditions and LOS F representing congested or constrained operating conditions.

Since the level of service of a traffic facility is a function of the traffic flows placed upon it, such a facility may operate at a wide range of levels of service, depending on the time of day, day of week, or period of year.

⁵The capacity analysis methodology is based on the concepts and procedures presented in the *Highway Capacity Manual 6th Edition*; Transportation Research Board; Washington, DC; 2016.

Signalized Intersections

The six levels of service for signalized intersections may be described as follows:

- *LOS A* describes operations with very low control delay; most vehicles do not stop at all.
- *LOS B* describes operations with relatively low control delay. However, more vehicles stop than *LOS A*.
- *LOS C* describes operations with higher control delays. Individual cycle failures may begin to appear. The number of vehicles stopping is significant at this level, although many still pass through the intersection without stopping.
- *LOS D* describes operations with control delay in the range where the influence of congestion becomes more noticeable. Many vehicles stop and individual cycle failures are noticeable.
- *LOS E* describes operations with high control delay values. Individual cycle failures are frequent occurrences.
- *LOS F* describes operations with high control delay values that often occur with over-saturation. Poor progression and long cycle lengths may also be major contributing causes to such delay levels.

Levels of service for signalized intersections are calculated using the operational analysis methodology of the 2000 *Highway Capacity Manual*⁶ and implemented as a part of the Synchro® software. This method assesses the effects of signal type, timing, phasing, and progression; vehicle mix; and geometrics on delay. Level-of-service designations are based on the criterion of control or signal delay per vehicle. Control or signal delay is a measure of driver discomfort, frustration, and fuel consumption, and includes initial deceleration delay approaching the traffic signal, queue move-up time, stopped delay, and final acceleration delay. Table 10 summarizes the relationship between level of service and control delay. The tabulated control delay criterion may be applied in assigning level-of-service designations to individual lane groups, to individual intersection approaches, or to entire intersections.

Table 10
LEVEL-OF-SERVICE CRITERIA
FOR SIGNALIZED INTERSECTIONS^a

Level of Service	Control (Signal) Delay Per Vehicle (Seconds)
A	≤10.0
B	10.1 to 20.0
C	20.1 to 35.0
D	35.1 to 55.0
E	55.1 to 80.0
F	>80.0

^aSource: *Highway Capacity Manual*, Transportation Research Board; Washington, DC; 2000; page 16-2.

⁶*Highway Capacity Manual*; Transportation Research Board; Washington, DC; 2000.

Unsignalized Intersections

The six levels of service for unsignalized intersections may be described as follows:

- *LOS A* represents a condition with little or no control delay to minor street traffic.
- *LOS B* represents a condition with short control delays to minor street traffic.
- *LOS C* represents a condition with average control delays to minor street traffic.
- *LOS D* represents a condition with long control delays to minor street traffic.
- *LOS E* represents operating conditions at or near capacity level, with very long control delays to minor street traffic.
- *LOS F* represents a condition where minor street demand volume exceeds capacity of an approach lane, with control delays resulting.

The levels of service of unsignalized intersections are determined by application of a procedure described in the 2000 *Highway Capacity Manual*. Level of service is measured in terms of average control delay. Mathematically, control delay is a function of the capacity and degree of saturation of the lane group and/or approach under study and is a quantification of motorist delay associated with traffic control devices such as traffic signals and STOP signs. Control delay includes the effects of initial deceleration delay approaching a STOP sign, stopped delay, queue move-up time, and final acceleration delay from a stopped condition. Definitions for level of service at unsignalized intersections are also given in the 2000 *Highway Capacity Manual*. Table 11 summarizes the relationship between level of service and average control delay.

Table 11
LEVEL-OF-SERVICE CRITERIA FOR
UNSIGNALIZED INTERSECTIONS^a

Level of Service	Average Control Delay (Seconds Per Vehicle)
A	≤ 10.0
B	10.1 to 15.0
C	15.1 to 25.0
D	25.1 to 35.0
E	35.1 to 50.0
F	>50.0

^aSource: *Highway Capacity Manual*; Transportation Research Board; Washington, DC; 2000; page 17-2.

ANALYSIS RESULTS

Level-of-service analyses were conducted for 2024 Existing, 2025/2035 No-Build, and 2025/2035 Build conditions for the study area intersections. The results of the intersection capacity analysis within the study area are described below, with a tabular summary provided in Tables 12 and 13. Detailed operations worksheets are provided in the Appendix.

Signalized Intersection

Dover Road/Main Street at Newmarket Road/Holiday Inn Express Driveway

Under 2024 Existing, 2025 Opening-Year No-Build, and 2035 Design-Year No-Build conditions, this intersection operates at an overall LOS C during the weekday morning peak hour and at LOS D during the weekday evening and Saturday midday peak hours. No changes to overall LOS occur under 2025 Opening-Year Build conditions due to the addition of the Project traffic. No changes to overall LOS occur under 2035 Design-Year Build conditions due to the addition of the Project traffic except for during the Saturday midday peak hour where the LOS goes from LOS D with 54.9 seconds of delay to LOS E with 55.7 seconds of delay. An increase of 0.8 seconds in delay will be undetectable to motorists.

Table 12
SIGNALIZED INTERSECTION LEVEL-OF-SERVICE AND VEHICLE QUEUE SUMMARY

Signalized Intersection/Peak Hour/Movement	2024 Existing				2025 Opening-Year No-Build				2025 Opening-Year Build				2035 Design-Year No-Build				2035 Design-Year Build			
	V/C ^a	Delay ^b	LOS ^c	Queue ^d 50 th /95 th	V/C	Delay	LOS	Queue 50 th /95 th	V/C	Delay	LOS	Queue 50 th /95 th	V/C	Delay	LOS	Queue 50 th /95 th	V/C	Delay	LOS	Queue 50 th /95 th
Dover Road/Main Street at Newmarket Road/ Holiday Inn Express Driveway																				
<i>Weekday Morning:</i>																				
Main Street EB LT	0.04	46.8	D	1/10	0.04	46.9	D	1/10	0.04	45.6	D	1/11	0.04	47.1	D	1/10	0.04	47.1	D	1/10
Main Street EB TH	0.41	32.5	C	97/207	0.41	32.6	C	98/209	0.40	31.3	C	92/212	0.43	32.4	C	107/231	0.43	32.4	C	108/232
Main Street EB RT	0.07	28.8	C	0/19	0.07	28.9	C	0/20	0.07	27.8	C	0/21	0.07	28.4	C	0/30	0.07	28.4	C	0/30
Dover Road WB LT	0.78	39.4	D	211/554	0.79	40.3	D	217/566	0.75	36.5	D	198/587	0.84	44.5	D	238/665	0.86	46.4	D	245/685
Dover Road WB TH/RT	0.31	12.6	B	68/238	0.31	12.7	B	70/240	0.29	11.6	B	60/245	0.33	12.5	B	74/269	0.33	12.5	B	74/270
Newmarket Road NB LT/TH	0.58	36.2	D	90/184	0.59	36.4	D	92/188	0.55	35.7	D	77/193	0.58	36.7	D	88/217	0.58	36.7	D	88/217
Newmarket Road NB RT	0.40	31.9	C	0/22	0.40	32.0	C	0/21	0.35	31.8	C	0/99	0.38	32.4	C	0/107	0.39	32.5	C	0/107
Holiday Inn Express Driveway SB LT/TH/RT	0.01	27.6	C	0/0	0.01	27.6	C	0/0	0.00	28.2	C	0/0	0.00	28.2	C	0/0	0.00	28.2	C	0/0
Overall	--	31.0	C	--	--	31.3	C	--	--	29.8	C	--	--	32.4	C	--	--	32.9	C	--
<i>Weekday Afternoon:</i>																				
Main Street EB LT	0.24	55.3	E	8/30	0.24	55.6	E	8/30	0.21	53.1	D	7/32	0.22	55.3	E	8/32	0.22	55.3	E	8/32
Main Street EB TH	0.67	34.9	C	246/434	0.67	35.3	D	254/444	0.63	33.5	C	221/468	0.68	35.5	D	260/549	0.68	35.5	D	260/549
Main Street EB RT	0.13	26.2	C	0/45	0.13	26.3	C	0/46	0.12	25.8	C	0/61	0.14	26.3	C	0/63	0.14	26.3	C	0/63
Dover Road WB LT	0.92	59.6	E	295/675	0.93	62.0	E	304/685	0.94	61.2	E	306/730	1.08	101.5	F	384/824	1.09	103.4	F	400/830
Dover Road WB TH/RT	0.28	11.1	B	65/249	0.28	11.3	B	68/252	0.29	10.8	B	66/264	0.32	11.7	B	81/293	0.32	11.7	B	81/294
Newmarket Road NB LT/TH	0.61	43.3	D	97/178	0.61	43.3	D	97/179	0.58	41.7	D	86/183	0.61	43.2	D	98/203	0.61	43.2	D	98/203
Newmarket Road NB RT	0.31	36.3	D	0/45	0.32	36.3	D	0/45	0.29	35.6	D	0/89	0.32	36.4	D	0/95	0.32	36.4	D	0/95
Holiday Inn Express Driveway SB LT/TH/RT	0.03	33.0	C	3/10	0.03	33.0	C	3/10	0.01	32.6	C	1/18	0.01	33.0	C	2/18	0.01	33.0	C	2/18
Overall	--	37.5	D	--	--	38.1	D	--	--	37.5	D	--	--	48.4	D	--	--	48.9	D	--
<i>Saturday Midday:</i>																				
Main Street EB LT	0.14	55.7	E	5/21	0.14	55.8	E	5/21	0.15	55.2	E	5/23	0.15	56.6	E	5/23	0.15	56.6	E	5/23
Main Street EB TH	0.72	38.6	D	270/510	0.73	38.7	D	275/519	0.69	37.5	D	247/533	0.74	40.1	D	287/618	0.75	40.1	D	288/620
Main Street EB RT	0.18	27.9	C	0/48	0.18	27.9	C	0/49	0.17	28.0	C	0/68	0.19	28.4	C	1/73	0.19	28.4	C	1/74
Dover Road WB LT	1.04	91.8	F	333/711	1.06	97.5	F	340/721	1.00	79.1	E	321/735	1.14	124.9	F	399/825	1.15	127.8	F	404/834
Dover Road WB TH/RT	0.34	12.8	B	80/286	0.34	12.9	B	82/289	0.33	12.7	B	77/292	0.37	13.6	B	92/326	0.37	13.6	B	92/327
Newmarket Road NB LT/TH	0.63	46.5	D	98/199	0.63	46.8	D	99/201	0.62	45.5	D	97/201	0.66	48.1	D	109/222	0.66	48.1	D	109/222
Newmarket Road NB RT	0.27	38.1	D	0/80	0.27	38.1	D	0/81	0.27	37.6	D	0/87	0.30	38.3	D	0/91	0.30	38.4	D	0/92
Holiday Inn Express Driveway SB LT/TH/RT	0.04	35.4	D	4/19	0.04	35.4	D	4/19	0.02	34.8	C	3/23	0.02	35.1	D	3/23	0.02	35.1	D	3/23
Overall	--	46.3	D	--	--	47.7	D	--	--	43.0	D	--	--	54.9	D	--	--	55.7	E	--

^aVolume-to-capacity ratio.

^bDelay per vehicle in seconds.

^cLevel of service.

^dQueue length in feet.

Unsignalized Intersections

Dover Road at Irving Gas Station Driveway

Under 2024 Existing, 2025 Opening-Year No-Build, and 2035 Design-Year No-Build conditions, the critical movement at this intersection (left turns into the driveway) operates at LOS A during the weekday morning, weekday evening, and Saturday midday peak hours. No changes to the critical movement level-of-service occur under 2025 Opening-Year Build or 2035 Design-Year Build conditions due to the addition of Project traffic.

Dover Road at Irving Gas Station Driveway/Holiday Inn Express Driveway

Under 2024 Existing, 2025 Opening-Year No-Build, and 2035 Design-Year No-Build conditions, the critical movements at this intersection operate at LOS F or better during the weekday morning, weekday evening, and Saturday midday peak hours. Under 2025 Opening-Year Build conditions, the critical movements at this intersection operate at LOS E or better during the weekday morning, weekday evening, and Saturday midday peak hours. Under 2035 Design-Year Build conditions, the critical movements at this intersection operate at LOS F or better during the weekday morning, weekday evening, and Saturday midday peak hours. The 95th percentile vehicle queue length for the critical movements is expected to be 44 feet or less under Build conditions which is equivalent to approximately 2 vehicles. It should be noted that operations improve at this intersection under Build conditions due to the redistribution of traffic from the Dunkin' at the Irving gas station to the Project site.

Dover Road at Project Site Driveway

Analysis was assumed without any exiting turn prohibitions in order to provide a conservative analysis. Under 2025 Opening-Year Build and 2035 Design-Year Build conditions, the critical movement at this intersection operates at LOS F during the weekday morning, weekday evening, and Saturday midday peak hours. The 95th percentile vehicle queue length for the critical movement is expected to be 129 feet or less under Build conditions, which is less than 6 vehicles. This only occurs during the weekday morning peak hour under the 2035 Design-Year Build condition for 3 minutes out of the peak hour. The 95th percentile vehicle queue length is under 100 feet or less than 4 vehicles during the other time periods and conditions analyzed.

Table 13
UNSIGNALIZED INTERSECTION LEVEL-OF-SERVICE AND VEHICLE QUEUE SUMMARY

Unsignalized Intersection/Peak Hour/Movement	2024 Existing				2025 Opening-Year No-Build				2025 Opening-Year Build				2035 Design-Year No-Build ^e				2035 Design-Year Build ^e			
	Demand ^a	Delay ^b	LOS ^c	Queue ^d 95 th	Demand	Delay	LOS	Queue 95 th	Demand	Delay	LOS	Queue 95 th	Demand	Delay	LOS	Queue 95 th	Demand	Delay	LOS	Queue 95 th
Dover Road at Irving Gas Station Driveway																				
<i>Weekday Morning:</i>																				
Dover Road WB LT/TH	658	0.1	A	1	665	0.1	A	1	677	0.1	A	1	734	0.1	A	1	746	0.1	A	1
<i>Weekday Afternoon:</i>																				
Dover Road WB LT/TH	747	0.1	A	0	755	0.1	A	0	759	0.1	A	0	833	0.1	A	0	837	0.1	A	0
<i>Saturday Midday:</i>																				
Dover Road WB LT/TH	777	0.1	A	0	785	0.1	A	0	790	0.1	A	0	867	0.1	A	0	872	0.1	A	0
Dover Road at Irving Gas Station Driveway/ Holiday Inn Express Driveway																				
<i>Weekday Morning:</i>																				
Irving Gas Station NB LT/TH	33	44.4	E	38	33	46.0	E	39	6	27.7	D	3	33	44.7	E	28	6	33.6	D	4
Irving Gas Station NB RT	71	18.6	C	31	71	18.9	C	32	51	15.8	C	13	71	18.1	C	21	51	17.6	C	15
Holiday Inn Express Driveway SB LT/TH/RT	0	--	--	--	0	--	--	--	0	--	--	--	0	--	--	--	0	--	--	--
<i>Weekday Afternoon:</i>																				
Irving Gas Station NB LT/TH	31	60.8	F	39	31	63.6	F	40	20	44.6	E	17	31	77.8	F	42	20	62.6	F	24
Irving Gas Station NB RT	57	20.8	C	23	57	21.2	C	24	49	18.5	C	15	57	21.8	C	21	49	21.4	C	18
Holiday Inn Express Driveway SB LT/TH/RT	0	--	--	--	0	--	--	--	0	--	--	--	0	--	--	--	0	--	--	--
<i>Saturday Midday:</i>																				
Irving Gas Station NB LT/TH	48	65.2	F	59	48	68.6	F	61	33	49.9	E	31	48	106.8	F	75	33	76.2	F	44
Irving Gas Station NB RT	73	18.8	C	25	73	19.0	C	25	61	18.0	C	18	73	21.3	C	27	61	21.0	C	22
Holiday Inn Express Driveway SB LT/TH/RT	3	56.7	F	8	3	59.4	F	9	3	46.7	E	3	3	78.1	F	4	3	72.2	F	4
Dover Road at the Project Site Driveway																				
<i>Weekday Morning:</i>																				
Project Site Driveway SB LT/RT	0	--	--	--	0	--	--	--	100	59.3	F	94	0	--	--	--	100	99.9	F	129
<i>Weekday Afternoon:</i>																				
Project Site Driveway SB LT/RT	0	--	--	--	0	--	--	--	40	53.0	F	39	0	--	--	--	40	85.9	F	56
<i>Saturday Midday:</i>																				
Project Site Driveway SB LT/RT	0	--	--	--	0	--	--	--	56	73.5	F	67	0	--	--	--	56	143.3	F	99

^aDemand in vehicles per hour.

^bDelay per vehicle in seconds.

^cLevel of service.

^dQueue length in feet.

Mitigated Analysis Results

The intersection of Dover Road at the Project site driveway was analyzed under 2025 Opening Year Build and 2035 Design Year Build conditions assuming an eastbound left turn lane on Dover Road. This analysis was conducted as the intersection meets the left turn lane warrants; however, no left-turn lane into the site is proposed on Dover Road. The results of the mitigated analysis are presented in Table 14.

Dover Road at Project Site Driveway

Under 2025 Opening-Year Build Mitigated and 2035 Design-Year Build Mitigated conditions the critical movement at this intersection operates at LOS F during the weekday morning, weekday evening, and Saturday midday peak hours. The overall mitigated analysis results are between 0.1 and 1.4 seconds better than the unmitigated build conditions. The 95th percentile vehicle queue length for the critical movement is expected to decrease by at most 1 foot.

Table 14
MITIGATED INTERSECTION LEVEL-OF-SERVICE AND VEHICLE QUEUE SUMMARY

Unsignalized Intersection/Peak Hour/Movement	2025 Opening-Year Build				2025 Opening-Year Build Mitigated				2035 Design-Year Build				2035 Design-Year Build Mitigated			
	Demand ^a	Delay ^b	LOS ^c	Queue ^d 95 th	Demand	Delay	LOS	Queue 95 th	Demand	Delay	LOS	Queue 95 th	Demand	Delay	LOS	Queue 95 th
<i>Dover Road at the Project Site Driveway</i>																
<i>Weekday Morning:</i>																
Project Site Driveway SB LT/RT	100	59.3	F	94	100	58.8	F	93	100	99.9	F	129	100	98.8	F	128
<i>Weekday Afternoon:</i>																
Project Site Driveway SB LT/RT	40	53.0	F	39	40	52.9	F	38	40	85.9	F	56	40	85.6	F	56
<i>Saturday Midday:</i>																
Project Site Driveway SB LT/RT	56	73.5	F	67	56	73.0	F	67	56	143.3	F	99	56	141.9	F	98

^aDemand in vehicles per hour.

^bDelay per vehicle in seconds.

^cLevel of service.

^dQueue length in feet.

RECOMMENDATIONS AND CONCLUSIONS

VAI has prepared this TIS to identify traffic impacts associated with a proposed Dunkin' coffee shop to be located at 3 Dover Road (NH Route 108) in Durham, New Hampshire. This Project consists of a relocation of an existing Dunkin' coffee shop currently located at 4 Dover Road and as such represents a redistribution of customer traffic along with a slight increase in vehicle trips based on an expansion in store size. Based on the results of this study, the following can be concluded:

- As compared with the existing coffee shop, the expansion is expected to generate 232 additional vehicle trips on an average weekday with 49 vehicle trips during the weekday morning peak hour and 20 additional vehicle trips during the weekday evening peak hour. On Saturday, the Project is expected to generate 252 additional vehicle trips with 30 additional vehicle trips during the Saturday midday peak hour.
- In total, the relocated coffee shop is expected to generate 868 vehicle trips on an average weekday with 183 vehicle trips during the weekday morning peak hour and 75 vehicle trips during the weekday evening peak hour. On Saturday, the Project is expected to generate 946 vehicle trips with 111 vehicle trips during the Saturday midday peak hour.
- Project-related traffic-volume increases external to the study area relative to 2025 and 2035 No-Build conditions are anticipated to range from 1 to 13 vehicles or 0.1 to 1.1 percent during the peak periods.
- The sight distance at the intersection of the Project site driveway with Dover Road was found to exceed the minimum recommended values for SSD, ISD, All Season Safe Sight Distance, and the desirable values for ISD.

In consideration of the above, we have concluded that the Project can be accommodated within the confines of the existing transportation infrastructure in a safe and efficient manner with the implementation of the following recommendations.

RECOMMENDATIONS

The following improvements have been recommended as a part of this evaluation:

Project Access

Access to the Project site will be provided via the curb cut onto Dover Road. It is suggested that the driveway be placed under a peak-hour exiting left-turn prohibition for 7-9AM and 4-6PM. During non-peak hours, the left turn movement may be able to be processed as both volumes exiting the site and volumes on Dover Road would be lower during off-peak periods. A Conceptual Signage Plan is shown on Figure 11.

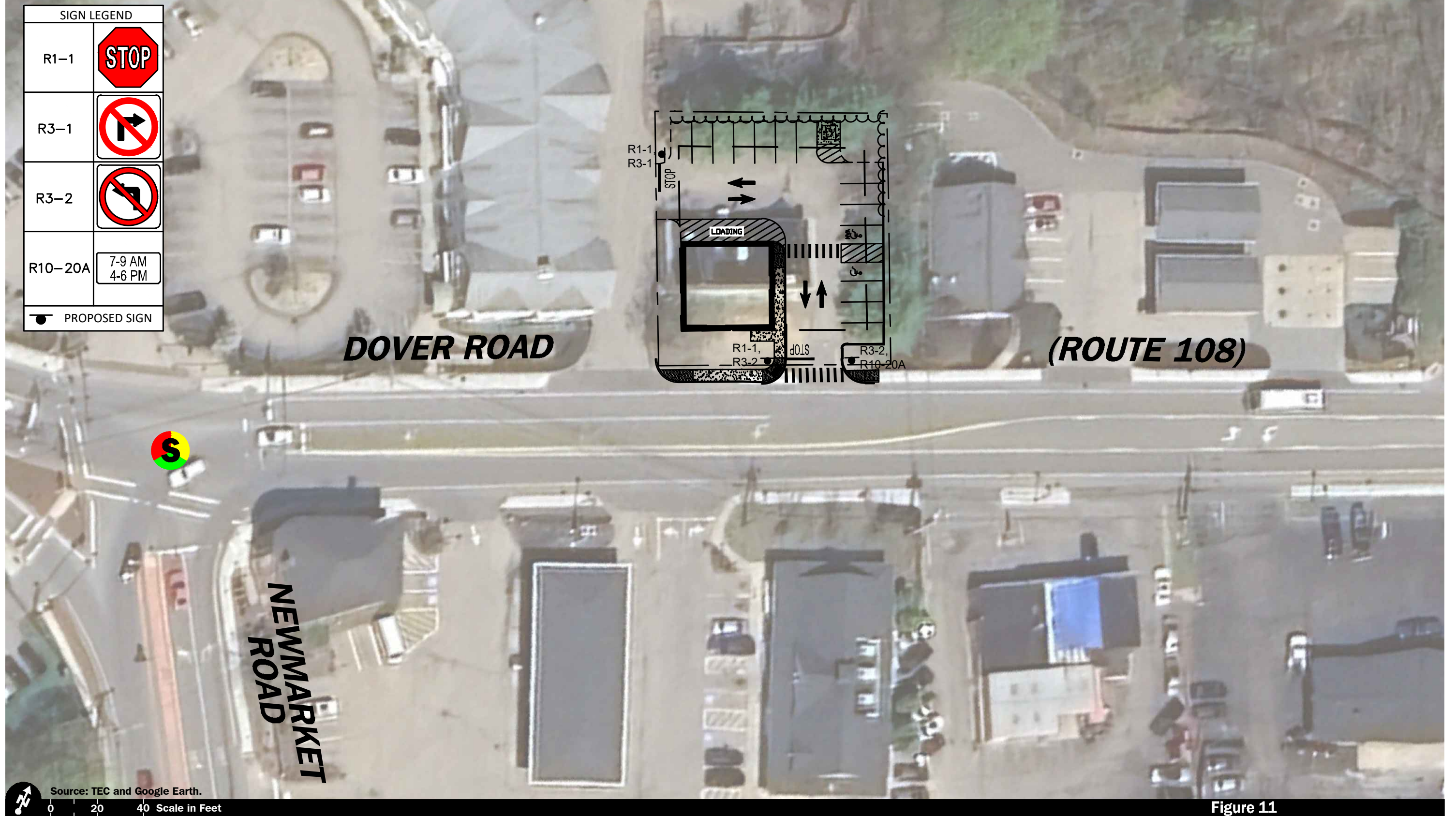

Figure 11
Conceptual Signage Plan
Dover Road (Route 108) at
Project Site Driveway

The following recommendations are offered with respect to the design and operation of the Project site driveway:

- The Project site driveway should be designed to accommodate the turning and maneuvering requirements of the largest expected delivery and emergency vehicles.
- The driveway should be placed under STOP-sign (MUTCD⁷ R1-1) control, with a painted STOP-bar included.
- All signs and other pavement markings to be installed within the Project site shall conform to the applicable standards of the current MUTCD.
- Signs and landscaping to be installed as a part of the Project within the intersection sight triangle areas should be designed and maintained so as not to restrict lines of sight.
- Snow accumulations (windrows) within sight triangle areas should be promptly removed where such accumulations would impede sightlines.

CONCLUSIONS

As documented in this study, Project-related traffic increases will not result in significant increases in traffic volumes or traffic delays within the study area. Although the Project site driveway will operate with delay during peak hours, these delays will be realized on-site. The peak-period prohibition on left turns out of the site will allow operations on Dover Road, where motorists use the center turn lane as a de facto westbound left-turn lane, to continue as they currently exist.

The Project represents a redistribution of trips from an existing Dunkin' coffee shop to a new location across Dover Road; therefore, many of the existing trips are already on the road network. However, if the new site does not align with customers' travel patterns, they will most likely find other businesses to frequent. In general, Project-related traffic can be accommodated within the existing and future infrastructure with manageable impact to the general traffic operations within the study area.

⁷Ibid 1.

APPENDIX

TRAFFIC COUNT DATA
COVID ADJUSTMENT DATA
SEASONAL ADJUSTMENT DATA
PUBLIC TRANSPORTATION SCHEDULES
VEHICLE SPEED DATA
GROWTH RATE DATA
TRIP GENERATION DATA
TURN LANE WARRANT ANALYSIS
CAPACITY ANALYSIS



TRAFFIC COUNT DATA



Accurate Counts
978-664-2565

S d 1007 001

S		D r		, 3D rR d		rT		, rT		dT		
10	31	20	24	T	M r	A r	M r	A r	M r	A r	M r	A r
12	00					6	111			9	0	
12	1					10	134			9	79	
12	30					11	129			3	100	
12	4					9	137	36	11	9	90	30 349 66 60
1	00						160			4	106	
1	1					6	131				93	
1	30					2	111			3	123	
1	4					3	133	16	3	2	9	14 411 30 946
2	00						13			4	9	
2	1					3	143			2	19	
2	30					2	131			3	133	
2	4					3	16	13	6	3	12	12 1 2 10 6
3	00					6	142			4	12	
3	1					3	142			3	7	
3	30					4	137			6	9	
3	4						136	1	7	9	0	22 369 40 926
4	00						113				107	
4	1					6	121			12	3	
4	30						10			17	4	
4	4					11	117	30	4 9	12	6	46 270 76 729
	00					17	12			16	74	
	1					33	117			30	91	
	30					43	140			32	77	
	4					41	149	134	31	2	111	103 3 3 237 4
	6 00					2	146			47	7	
	6 1					3	16				116	
	6 30					70	12			93	10	
	6 4					72	91	223	1	11	9	313 406 36 924
	7 00					10	122			112	100	
	7 1					111	117			13		
	7 30					14	92			176	72	
	7 4					164	74	31	40	193	7	619 347 11 0 7 2
						129	92			139	4	
						1	13	96		144	79	
						30	1			13	64	
						4	13	93	7	369	12	43 61 270 111 639
						9 00	11	7		114	66	
						9 1	147	69		122	7	
						9 30	130	7		119	46	
						9 4	122	6	17	260	92	4 447 23 964 49
						10 00	122	40		9	32	
						10 1	94	43		9	37	
						10 30	100	42		76	34	
						10 4	13	34	4 4	1 9	62	21 32 124 779 2 3
						11 00	109	29		3	30	
						11 1	121	27		10	41	
						11 30	109	34		7	2	
						11 4	111	20	4 0	110	100	21 37 120 2 230
	T					2979	49 2			2 70	3772	49 7 4
	P r					374	626			432	6	401 99

Accurate Counts
978-664-2565

S d 1007 001

D r R d											
3D r R d											
S D r ,											
11 1 2024 , r T , r T d T											
T	M r	A r	M r	A r	M r	A r	M r	A r	M r	A r	A r
12 00		1		116				7		126	
12 1		19		1 2				20		9	
12 30		20		149				17		116	
12 4		7		130	61	47		14		101	441 119 9
1 00		11		144				10		112	
1 1		9		132				2		127	
1 30		17		11				1		102	
1 4		10		14	47	36		20		106	70 447 117 9 3
2 00		10		147						132	
2 1		9		127				9		132	
2 30		7		14						1 0	
2 4		6		171	32	90		6		131	2 4 60 113
3 00		10		137				3		96	
3 1		6		142				3		69	
3 30		3		112						103	
3 4		4		160	23	1		9		91	23 3 9 46 910
4 00		9		163						121	
4 1		13		13				9		109	
4 30		10		124				10		9	
4 4		12		1	44	0		17		93	44 421 1001
00		21		1 1				22		116	
1		17		123				26		109	
30		3		1 9				33		11	
4		42		166	11	629		2		137	109 477 227 1106
6 00		37		13				4		146	
6 1		0		174				6		132	
6 30		62		16				102		133	
6 4		62		1 1	211	62		130		117	34 2 6 11 3
7 00		111		134				90		109	
7 1		103		16				137		1	
7 30		114		12				1 1		6	
7 4		140		13	46	6		1 9		9	37 374 100 939
00		132		120				12		79	
1		14		90				12		73	
30		11		100				11		6	
4		1 0		9	4	40		13		76	09 296 10 7 701
9 00		10		6				117		1	
9 1		103						110		74	
9 30		137		11				13			
9 4		110		67	4	33		103		40	46 2 3 923 91
10 00		10		4				134		47	
10 1		11						116		1	
10 30		10		3				109		34	
10 4		103		49	431	229		131		29	490 161 921 390
11 00		99		37				140		32	
11 1		10		33				113		42	
11 30		127		34				121		29	
11 4		131		32	46	136		12		21	499 124 964 260
T		2906		731				3177		4426	60 3 101 7
P r		33 6		66 4				41		2	37 62

Accurate Counts
978-664-2565

S d 1007 001

D r R d		3 D r R d									
S	D r	M d	T d	d d	T r d	rd	S rd	S d	A r		
10 2	2024										
12 00 AM					36	30	61	97	103	6	64
1 00					16	14	47	70	6	40	46
2 00					13	12	32	2	36	47	27
3 00					1	22	23	23	26	39	22
4 00					30	46	44	44	2	41	33
00					134	103	11	109		2	103
6 00					223	313	211	34		1 0	173
7 00					31	619	46	37	1 3	23	394
00					7	61	4	09	264	371	4 6
9 00					17	447	4	46	3 7	33	444
10 00					4 4	32	431	490	467	611	4 1
11 00					4 0	37	46	499	06	634	474
12 00 PM					11	349	47	441	499	679	19
1 00					3	411	36	447	634	633	6
2 00					6	1	90	4	622	60	93
3 00					7	369	1	3 9	6 9	6	99
4 00					4 9	270	0	421	693	47	77
00					31	3 3	629	477	609	01	90
6 00					1	406	62	2	473	4	39
7 00					40	347	6	374	401	4 2	4 7
00					369	270	40	296	324	293	366
9 00					260	23	33	2 3	2 6	240	2
10 00					1 9	124	229	161	176	142	1
11 00					110	120	136	124	129	10	12
T	0	0	0	0	7961	6642	637	7603	766	049	0
D	0	0	0	0	14603		16240		1 714		0
AMP					00	7 00	00	7 00	11 00	11 00	11 00
					7	619	4	37	06	634	474
PM P					2 00	2 00	00	2 00	4 00	12 00 PM	3 00
					6	1	629	4	693	679	99
T	0	0	0	0	14603		16240		1 714		0
ADT	ADT 1 , 19	AADT 1 , 19									1 20

Accurate Counts

978-664-2565

N/S Street : Holiday Inn / Newmarket Rd
 E/W Street : Dover Road / Main Street
 City/State : Durham, NH
 Weather : Clear

File Name : 10078001
 Site Code : 10078001
 Start Date : 10/31/2024
 Page No : 1

Groups Printed- Cars - Trucks

Start Time	Holiday Inn Express From North			Dover Rd From East			Newmarket Rd From South				Main St From West			Int. Total
	Left	Thru	Right	Left	Thru	Right	Left	Thru	Right	U-Tr	Left	Thru	Right	
07:00 AM	0	0	0	76	31	0	15	0	80	0	1	28	12	243
07:15 AM	1	1	3	80	27	0	29	1	94	0	0	39	17	292
07:30 AM	1	0	0	97	58	0	38	0	135	0	0	41	14	384
07:45 AM	1	0	0	100	86	0	55	0	149	0	0	44	22	457
Total	3	1	3	353	202	0	137	1	458	0	1	152	65	1376
08:00 AM	0	0	3	100	67	0	33	0	100	0	1	45	31	380
08:15 AM	1	0	0	96	46	0	28	0	95	0	1	43	28	338
08:30 AM	1	2	1	96	59	2	28	0	111	0	0	35	21	356
08:45 AM	1	2	0	89	54	1	44	0	85	0	0	34	20	330
Total	3	4	4	381	226	3	133	0	391	0	2	157	100	1404
Grand Total	6	5	7	734	428	3	270	1	849	0	3	309	165	2780
Apprch %	33.3	27.8	38.9	63	36.7	0.3	24.1	0.1	75.8	0	0.6	64.8	34.6	
Total %	0.2	0.2	0.3	26.4	15.4	0.1	9.7	0	30.5	0	0.1	11.1	5.9	
Cars	6	5	7	720	412	2	267	1	831	0	3	298	159	2711
% Cars	100	100	100	98.1	96.3	66.7	98.9	100	97.9	0	100	96.4	96.4	97.5
Trucks	0	0	0	14	16	1	3	0	18	0	0	11	6	69
% Trucks	0	0	0	1.9	3.7	33.3	1.1	0	2.1	0	0	3.6	3.6	2.5

Start Time	Holiday Inn Express From North				Dover Rd From East				Newmarket Rd From South					Main St From West				Int. Total
	Left	Thru	Right	App. Total	Left	Thru	Right	App. Total	Left	Thru	Right	U-Tr	App. Total	Left	Thru	Right	App. Total	
Peak Hour Analysis From 07:00 AM to 08:45 AM - Peak 1 of 1																		
Peak Hour for Entire Intersection Begins at 07:30 AM																		
07:30 AM	1	0	0	1	97	58	0	155	38	0	135	0	173	0	41	14	55	384
07:45 AM	1	0	0	1	100	86	0	186	55	0	149	0	204	0	44	22	66	457
08:00 AM	0	0	3	3	100	67	0	167	33	0	100	0	133	1	45	31	77	380
08:15 AM	1	0	0	1	96	46	0	142	28	0	95	0	123	1	43	28	72	338
Total Volume	3	0	3	6	393	257	0	650	154	0	479	0	633	2	173	95	270	1559
% App. Total	50	0	50		60.5	39.5	0		24.3	0	75.7	0		0.7	64.1	35.2		
PHF	.750	.000	.250	.500	.983	.747	.000	.874	.700	.000	.804	.000	.776	.500	.961	.766	.877	.853
Cars	3	0	3	6	385	249	0	634	154	0	470	0	624	2	166	89	257	1521
% Cars	100	0	100	100	98.0	96.9	0	97.5	100	0	98.1	0	98.6	100	96.0	93.7	95.2	97.6
Trucks	0	0	0	0	8	8	0	16	0	0	9	0	9	0	7	6	13	38
% Trucks	0	0	0	0	2.0	3.1	0	2.5	0	0	1.9	0	1.4	0	4.0	6.3	4.8	2.4

Accurate Counts

978-664-2565

File Name : 10078001
 Site Code : 10078001
 Start Date : 10/31/2024
 Page No : 2

N/S Street : Holiday Inn / Newmarket Rd
 E/W Street : Dover Road / Main Street
 City/State : Durham, NH
 Weather : Clear

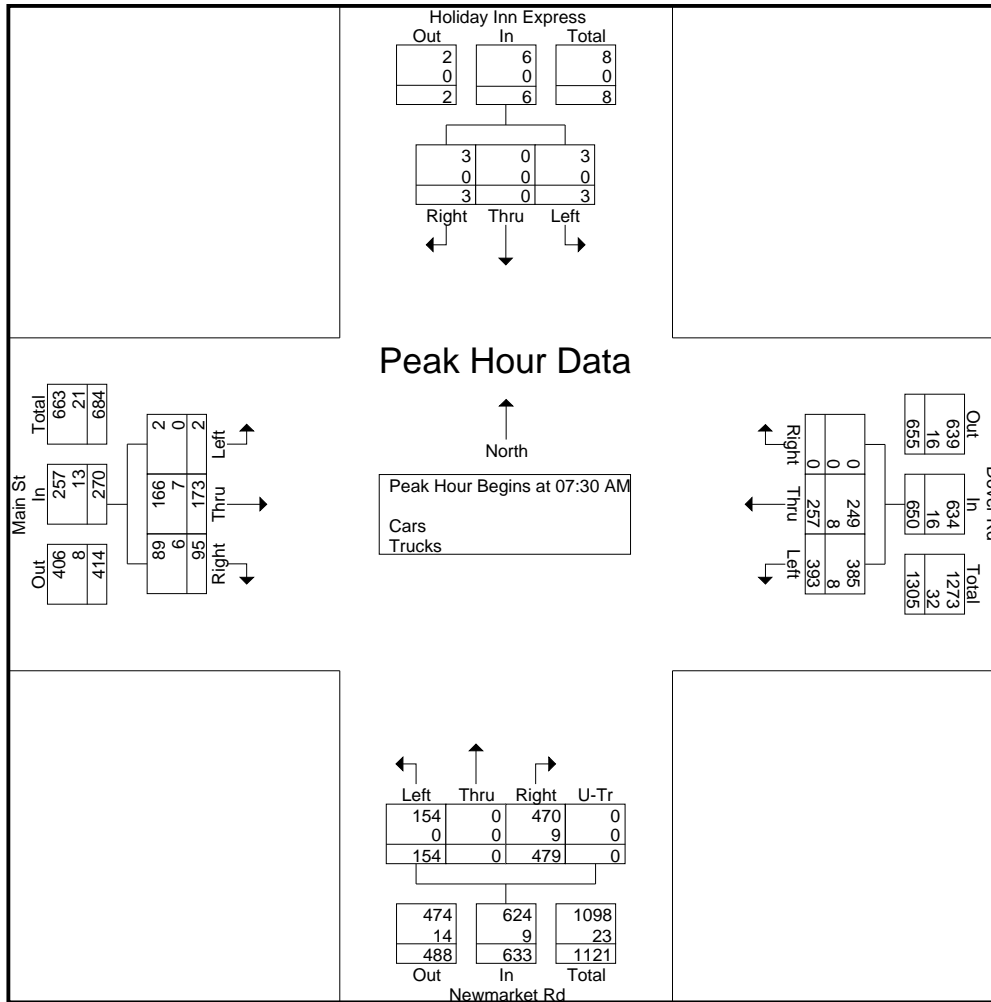

Peak Hour Analysis From 07:00 AM to 08:45 AM - Peak 1 of 1

Peak Hour for Each Approach Begins at:

	08:00 AM				07:45 AM				07:15 AM				07:45 AM				
+0 mins.	0	0	3	3	100	86	0	186	29	1	94	0	124	0	44	22	66
+15 mins.	1	0	0	1	100	67	0	167	38	0	135	0	173	1	45	31	77
+30 mins.	1	2	1	4	96	46	0	142	55	0	149	0	204	1	43	28	72
+45 mins.	1	2	0	3	96	59	2	157	33	0	100	0	133	0	35	21	56
Total Volume	3	4	4	11	392	258	2	652	155	1	478	0	634	2	167	102	271
% App. Total	27.3	36.4	36.4		60.1	39.6	0.3		24.4	0.2	75.4	0		0.7	61.6	37.6	
PHF	.750	.500	.333	.688	.980	.750	.250	.876	.705	.250	.802	.000	.777	.500	.928	.823	.880
Cars	3	4	4	11	383	253	2	638	154	1	469	0	624	2	160	97	259
% Cars	100	100	100	100	97.7	98.1	100	97.9	99.4	100	98.1	0	98.4	100	95.8	95.1	95.6
Trucks	0	0	0	0	9	5	0	14	1	0	9	0	10	0	7	5	12
% Trucks	0	0	0	0	2.3	1.9	0	2.1	0.6	0	1.9	0	1.6	0	4.2	4.9	4.4

Accurate Counts

978-664-2565

N/S Street : Holiday Inn / Newmarket Rd
 E/W Street : Dover Road / Main Street
 City/State : Durham, NH
 Weather : Clear

File Name : 10078001
 Site Code : 10078001
 Start Date : 10/31/2024
 Page No : 1

Groups Printed- Trucks

Start Time	Holiday Inn Express From North			Dover Rd From East			Newmarket Rd From South				Main St From West			Int. Total
	Left	Thru	Right	Left	Thru	Right	Left	Thru	Right	U-Tr	Left	Thru	Right	
07:00 AM	0	0	0	1	3	0	0	0	2	0	0	1	0	7
07:15 AM	0	0	0	2	1	0	1	0	2	0	0	1	0	7
07:30 AM	0	0	0	2	4	0	0	0	3	0	0	1	1	11
07:45 AM	0	0	0	1	2	0	0	0	1	0	0	3	2	9
Total	0	0	0	6	10	0	1	0	8	0	0	6	3	34
08:00 AM	0	0	0	2	1	0	0	0	3	0	0	2	0	8
08:15 AM	0	0	0	3	1	0	0	0	2	0	0	1	3	10
08:30 AM	0	0	0	3	1	0	1	0	3	0	0	1	0	9
08:45 AM	0	0	0	0	3	1	1	0	2	0	0	1	0	8
Total	0	0	0	8	6	1	2	0	10	0	0	5	3	35
Grand Total	0	0	0	14	16	1	3	0	18	0	0	11	6	69
Apprch %	0	0	0	45.2	51.6	3.2	14.3	0	85.7	0	0	64.7	35.3	
Total %	0	0	0	20.3	23.2	1.4	4.3	0	26.1	0	0	15.9	8.7	

Start Time	Holiday Inn Express From North				Dover Rd From East				Newmarket Rd From South					Main St From West				Int. Total
	Left	Thru	Right	App. Total	Left	Thru	Right	App. Total	Left	Thru	Right	U-Tr	App. Total	Left	Thru	Right	App. Total	
Peak Hour Analysis From 07:00 AM to 08:45 AM - Peak 1 of 1																		
Peak Hour for Entire Intersection Begins at 07:30 AM																		
07:30 AM	0	0	0	0	2	4	0	6	0	0	3	0	3	0	1	1	2	11
07:45 AM	0	0	0	0	1	2	0	3	0	0	1	0	1	0	3	2	5	9
08:00 AM	0	0	0	0	2	1	0	3	0	0	3	0	3	0	2	0	2	8
08:15 AM	0	0	0	0	3	1	0	4	0	0	2	0	2	0	1	3	4	10
Total Volume	0	0	0	0	8	8	0	16	0	0	9	0	9	0	7	6	13	38
% App. Total	0	0	0		50	50	0		0	0	100	0		0	53.8	46.2		
PHF	.000	.000	.000	.000	.667	.500	.000	.667	.000	.000	.750	.000	.750	.000	.583	.500	.650	.864

Accurate Counts

978-664-2565

N/S Street : Holiday Inn / Newmarket Rd

E/W Street : Dover Road / Main Street

City/State : Durham, NH

Weather : Clear

File Name : 10078001

Site Code : 10078001

Start Date : 10/31/2024

Page No : 1

Groups Printed- Bikes Peds

Start Time	Holiday Inn Express From North				Dover Rd From East				Newmarket Rd From South				Main St From West				Exclu. Total	Inclu. Total	Int. Total
	Left	Thru	Right	Peds	Left	Thru	Right	Peds	Left	Thru	Right	Peds	Left	Thru	Right	Peds			
07:00 AM	0	0	0	1	0	0	0	2	0	0	0	0	0	0	0	0	3	0	3
07:15 AM	0	0	0	0	0	0	0	0	0	0	0	0	0	0	0	0	0	0	0
07:30 AM	0	0	0	1	0	0	0	0	1	0	0	1	0	0	0	0	1	2	3
07:45 AM	0	0	0	1	0	2	0	1	0	0	0	1	0	0	0	0	2	3	5
Total	0	0	0	3	0	2	0	3	1	0	0	2	0	0	0	0	6	5	11
08:00 AM	0	0	0	0	0	0	0	0	0	0	0	0	0	0	0	0	0	0	0
08:15 AM	0	0	0	4	0	0	0	1	0	0	0	0	0	0	0	0	5	0	5
08:30 AM	0	0	0	2	1	0	0	0	0	0	0	0	0	0	0	0	2	1	3
08:45 AM	0	0	0	0	0	0	0	0	1	0	0	1	0	0	0	0	0	2	2
Total	0	0	0	6	1	0	0	1	1	0	0	1	0	0	0	0	7	3	10
Grand Total	0	0	0	9	1	2	0	4	2	0	0	3	0	0	0	0	13	8	21
Apprch %	0	0	0		33.3	66.7	0		40	0	0	60	0	0	0				
Total %	0	0	0		12.5	25	0		25	0	0	37.5	0	0	0		61.9	38.1	

Start Time	Holiday Inn Express From North				Dover Rd From East				Newmarket Rd From South				Main St From West				Int. Total	
	Left	Thru	Right	App. Total	Left	Thru	Right	App. Total	Left	Thru	Right	Peds	App. Total	Left	Thru	Right		App. Total
Peak Hour Analysis From 07:00 AM to 08:45 AM - Peak 1 of 1																		
Peak Hour for Entire Intersection Begins at 07:00 AM																		
07:00 AM	0	0	0	0	0	0	0	0	0	0	0	0	0	0	0	0	0	0
07:15 AM	0	0	0	0	0	0	0	0	0	0	0	0	0	0	0	0	0	0
07:30 AM	0	0	0	0	0	0	0	0	1	0	0	1	2	0	0	0	0	0
07:45 AM	0	0	0	0	0	2	0	2	0	0	0	1	1	0	0	0	0	0
Total Volume	0	0	0	0	0	2	0	2	1	0	0	2	3	0	0	0	0	0
% App. Total	0	0	0		0	100	0		33.3	0	0	66.7		0	0			
PHF	.000	.000	.000	.000	.000	.250	.000	.250	.250	.000	.000	.500	.375	.000	.000	.000	.000	.417

Accurate Counts

978-664-2565

N/S Street : Holiday Inn / Newmarket Rd
 E/W Street : Dover Road / Main Street
 City/State : Durham, NH
 Weather : Clear

File Name : 10078001
 Site Code : 10078001
 Start Date : 10/31/2024
 Page No : 1

Groups Printed- Cars - Trucks

Start Time	Holiday Inn Express From North				Dover Rd From East			Newmarket Rd From South				Main St From West			Int. Total
	Left	Thru	Right		Left	Thru	Right	Left	Thru	Right	U-Tr	Left	Thru	Right	
03:00 PM	0	1	1		98	61	1	34	0	92	0	0	83	58	429
03:15 PM	0	0	2		112	71	0	29	0	98	2	0	79	54	447
03:30 PM	2	0	1		109	73	1	32	0	102	1	1	100	66	488
03:45 PM	3	0	1		98	60	0	25	0	85	0	0	106	58	436
Total	5	1	5		417	265	2	120	0	377	3	1	368	236	1800
04:00 PM	1	0	1		98	60	0	32	0	92	0	2	90	57	433
04:15 PM	0	0	1		69	73	0	47	0	67	0	4	59	73	393
04:30 PM	0	2	5		86	57	2	68	0	69	2	6	41	55	393
04:45 PM	0	0	3		91	45	0	33	0	84	0	4	60	31	351
Total	1	2	10		344	235	2	180	0	312	2	16	250	216	1570
05:00 PM	1	0	1		116	75	0	48	1	109	1	3	102	62	519
05:15 PM	0	1	2		115	66	2	24	0	93	1	1	105	56	466
05:30 PM	0	1	4		123	72	2	32	0	90	0	5	82	35	446
05:45 PM	0	0	0		110	63	0	33	1	90	0	3	66	31	397
Total	1	2	7		464	276	4	137	2	382	2	12	355	184	1828
Grand Total	7	5	22		1225	776	8	437	2	1071	7	29	973	636	5198
Apprch %	20.6	14.7	64.7		61	38.6	0.4	28.8	0.1	70.6	0.5	1.8	59.4	38.8	
Total %	0.1	0.1	0.4		23.6	14.9	0.2	8.4	0	20.6	0.1	0.6	18.7	12.2	
Cars	7	5	22		1216	763	8	433	2	1060	7	29	963	635	5150
% Cars	100	100	100		99.3	98.3	100	99.1	100	99	100	100	99	99.8	99.1
Trucks	0	0	0		9	13	0	4	0	11	0	0	10	1	48
% Trucks	0	0	0		0.7	1.7	0	0.9	0	1	0	0	1	0.2	0.9

Start Time	Holiday Inn Express From North				Dover Rd From East				Newmarket Rd From South					Main St From West				Int. Total
	Left	Thru	Right	App. Total	Left	Thru	Right	App. Total	Left	Thru	Right	U-Tr	App. Total	Left	Thru	Right	App. Total	
Peak Hour Analysis From 03:00 PM to 05:45 PM - Peak 1 of 1																		
Peak Hour for Entire Intersection Begins at 05:00 PM																		
05:00 PM	1	0	1	2	116	75	0	191	48	1	109	1	159	3	102	62	167	519
05:15 PM	0	1	2	3	115	66	2	183	24	0	93	1	118	1	105	56	162	466
05:30 PM	0	1	4	5	123	72	2	197	32	0	90	0	122	5	82	35	122	446
05:45 PM	0	0	0	0	110	63	0	173	33	1	90	0	124	3	66	31	100	397
Total Volume	1	2	7	10	464	276	4	744	137	2	382	2	523	12	355	184	551	1828
% App. Total	10	20	70		62.4	37.1	0.5		26.2	0.4	73	0.4		2.2	64.4	33.4		
PHF	.250	.500	.438	.500	.943	.920	.500	.944	.714	.500	.876	.500	.822	.600	.845	.742	.825	.881
Cars	1	2	7	10	464	271	4	739	136	2	382	2	522	12	355	184	551	1822
% Cars	100	100	100	100	100	98.2	100	99.3	99.3	100	100	100	99.8	100	100	100	100	99.7
Trucks	0	0	0	0	0	5	0	5	1	0	0	0	1	0	0	0	0	6
% Trucks	0	0	0	0	0	1.8	0	0.7	0.7	0	0	0	0.2	0	0	0	0	0.3

Accurate Counts

978-664-2565

N/S Street : Holiday Inn / Newmarket Rd

E/W Street : Dover Road / Main Street

City/State : Durham, NH

Weather : Clear

File Name : 10078001

Site Code : 10078001

Start Date : 10/31/2024

Page No : 2

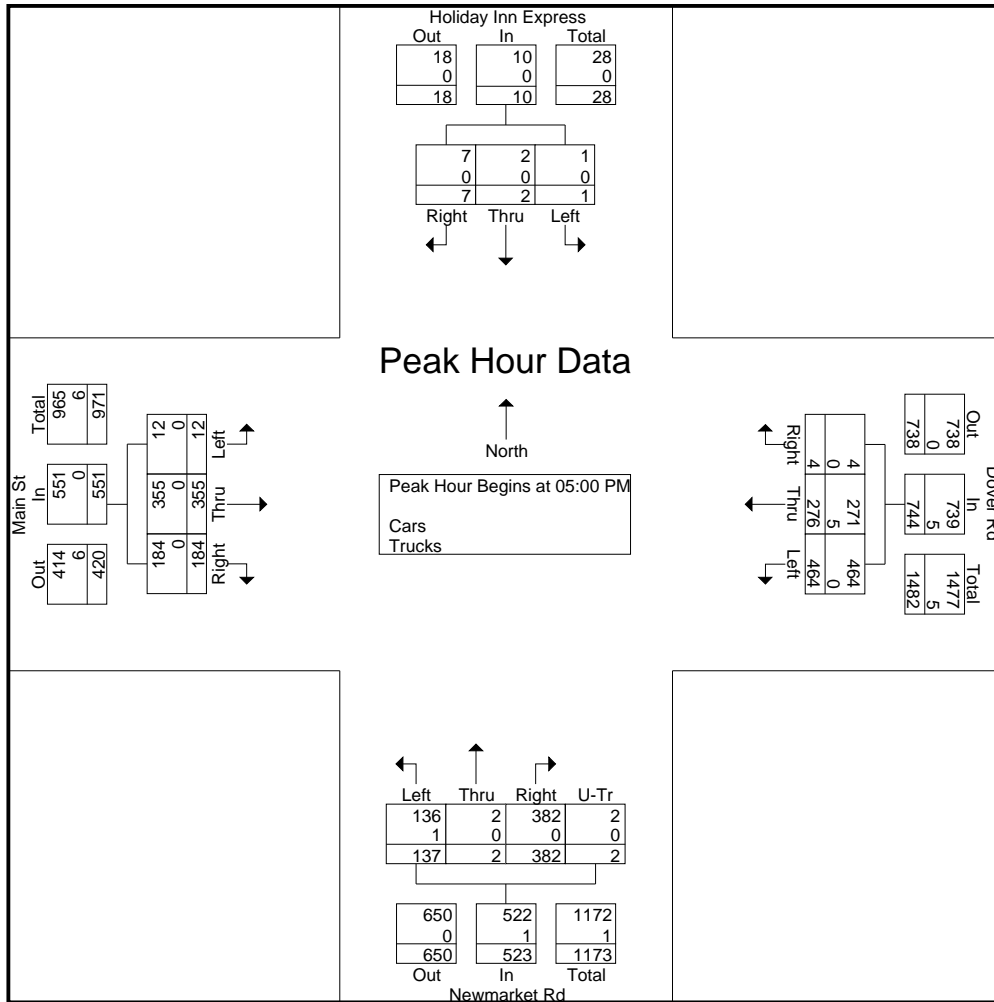

Peak Hour Analysis From 03:00 PM to 05:45 PM - Peak 1 of 1

Peak Hour for Each Approach Begins at:

	04:30 PM				05:00 PM				04:30 PM				03:30 PM				
+0 mins.	0	2	5	7	116	75	0	191	68	0	69	2	139	1	100	66	167
+15 mins.	0	0	3	3	115	66	2	183	33	0	84	0	117	0	106	58	164
+30 mins.	1	0	1	2	123	72	2	197	48	1	109	1	159	2	90	57	149
+45 mins.	0	1	2	3	110	63	0	173	24	0	93	1	118	4	59	73	136
Total Volume	1	3	11	15	464	276	4	744	173	1	355	4	533	7	355	254	616
% App. Total	6.7	20	73.3		62.4	37.1	0.5		32.5	0.2	66.6	0.8		1.1	57.6	41.2	
PHF	.250	.375	.550	.536	.943	.920	.500	.944	.636	.250	.814	.500	.838	.438	.837	.870	.922
Cars	1	3	11	15	464	271	4	739	171	1	355	4	531	7	351	253	611
% Cars	100	100	100	100	100	98.2	100	99.3	98.8	100	100	100	99.6	100	98.9	99.6	99.2
Trucks	0	0	0	0	0	5	0	5	2	0	0	0	2	0	4	1	5
% Trucks	0	0	0	0	0	1.8	0	0.7	1.2	0	0	0	0.4	0	1.1	0.4	0.8

Accurate Counts

978-664-2565

N/S Street : Holiday Inn / Newmarket Rd
 E/W Street : Dover Road / Main Street
 City/State : Durham, NH
 Weather : Clear

File Name : 10078001
 Site Code : 10078001
 Start Date : 10/31/2024
 Page No : 1

Groups Printed- Trucks

Start Time	Holiday Inn Express From North				Dover Rd From East			Newmarket Rd From South				Main St From West			Int. Total
	Left	Thru	Right		Left	Thru	Right	Left	Thru	Right	U-Tr	Left	Thru	Right	
03:00 PM	0	0	0		2	2	0	1	0	2	0	0	4	0	11
03:15 PM	0	0	0		3	1	0	0	0	1	0	0	1	0	6
03:30 PM	0	0	0		1	0	0	0	0	3	0	0	0	1	5
03:45 PM	0	0	0		0	2	0	1	0	2	0	0	3	0	8
Total	0	0	0		6	5	0	2	0	8	0	0	8	1	30
04:00 PM	0	0	0		1	0	0	0	0	0	0	0	1	0	2
04:15 PM	0	0	0		0	1	0	0	0	3	0	0	0	0	4
04:30 PM	0	0	0		1	0	0	1	0	0	0	0	0	0	2
04:45 PM	0	0	0		1	2	0	0	0	0	0	0	1	0	4
Total	0	0	0		3	3	0	1	0	3	0	0	2	0	12
05:00 PM	0	0	0		0	0	0	0	0	0	0	0	0	0	0
05:15 PM	0	0	0		0	0	0	1	0	0	0	0	0	0	1
05:30 PM	0	0	0		0	2	0	0	0	0	0	0	0	0	2
05:45 PM	0	0	0		0	3	0	0	0	0	0	0	0	0	3
Total	0	0	0		0	5	0	1	0	0	0	0	0	0	6
Grand Total	0	0	0		9	13	0	4	0	11	0	0	10	1	48
Apprch %	0	0	0		40.9	59.1	0	26.7	0	73.3	0	0	90.9	9.1	
Total %	0	0	0		18.8	27.1	0	8.3	0	22.9	0	0	20.8	2.1	

Start Time	Holiday Inn Express From North				Dover Rd From East				Newmarket Rd From South					Main St From West				Int. Total
	Left	Thru	Right	App. Total	Left	Thru	Right	App. Total	Left	Thru	Right	U-Tr	App. Total	Left	Thru	Right	App. Total	
Peak Hour Analysis From 03:00 PM to 05:45 PM - Peak 1 of 1																		
Peak Hour for Entire Intersection Begins at 03:00 PM																		
03:00 PM	0	0	0	0	2	2	0	4	1	0	2	0	3	0	4	0	4	11
03:15 PM	0	0	0	0	3	1	0	4	0	0	1	0	1	0	1	0	1	6
03:30 PM	0	0	0	0	1	0	0	1	0	0	3	0	3	0	0	1	1	5
03:45 PM	0	0	0	0	0	2	0	2	1	0	2	0	3	0	3	0	3	8
Total Volume	0	0	0	0	6	5	0	11	2	0	8	0	10	0	8	1	9	30
% App. Total	0	0	0	0	54.5	45.5	0	68.8	20	0	80	0	83.3	0	88.9	11.1	68.2	
PHF	.000	.000	.000	.000	.500	.625	.000	.688	.500	.000	.667	.000	.833	.000	.500	.250	.563	.682

Accurate Counts

978-664-2565

N/S Street : Holiday Inn / Newmarket Rd

E/W Street : Dover Road / Main Street

City/State : Durham, NH

Weather : Clear

File Name : 10078001

Site Code : 10078001

Start Date : 10/31/2024

Page No : 1

Groups Printed- Bikes Peds

Start Time	Holiday Inn Express From North				Dover Rd From East				Newmarket Rd From South				Main St From West				Exclu. Total	Inclu. Total	Int. Total
	Left	Thru	Right	Peds	Left	Thru	Right	Peds	Left	Thru	Right	Peds	Left	Thru	Right	Peds			
03:00 PM	0	0	0	0	0	1	0	1	0	0	0	1	0	0	1	2	3	3	6
03:15 PM	0	0	0	2	0	0	0	2	1	0	0	0	0	0	0	1	5	1	6
03:30 PM	0	0	0	8	0	0	0	11	0	0	0	1	0	0	0	0	19	1	20
03:45 PM	0	0	0	7	1	0	0	4	0	0	0	1	0	1	0	0	11	3	14
Total	0	0	0	17	1	1	0	18	1	0	0	3	0	1	1	3	38	8	46
04:00 PM	0	0	0	4	0	1	0	5	0	0	0	2	0	0	0	0	9	3	12
04:15 PM	0	0	0	1	0	0	0	0	0	0	0	0	0	0	0	0	1	0	1
04:30 PM	0	0	0	3	0	0	0	0	0	0	0	0	0	0	0	0	3	0	3
04:45 PM	0	0	0	1	0	0	0	1	0	0	0	0	0	0	1	0	2	1	3
Total	0	0	0	9	0	1	0	6	0	0	0	2	0	0	1	0	15	4	19
05:00 PM	0	0	0	3	0	0	0	0	0	0	0	1	0	0	0	0	3	1	4
05:15 PM	0	0	0	0	0	0	0	1	0	0	0	4	0	0	0	0	1	4	5
05:30 PM	0	0	0	1	0	0	0	1	0	0	0	2	0	0	0	0	2	2	4
05:45 PM	0	0	0	0	0	0	0	0	0	0	0	2	0	0	0	0	0	2	2
Total	0	0	0	4	0	0	0	2	0	0	0	9	0	0	0	0	6	9	15
Grand Total	0	0	0	30	1	2	0	26	1	0	0	14	0	1	2	3	59	21	80
Apprch %	0	0	0		33.3	66.7	0		6.7	0	0	93.3	0	33.3	66.7				
Total %	0	0	0		4.8	9.5	0		4.8	0	0	66.7	0	4.8	9.5		73.8	26.2	

Start Time	Holiday Inn Express From North				Dover Rd From East				Newmarket Rd From South				Main St From West				Int. Total	
	Left	Thru	Right	App. Total	Left	Thru	Right	App. Total	Left	Thru	Right	Peds	App. Total	Left	Thru	Right		App. Total
Peak Hour Analysis From 03:00 PM to 05:45 PM - Peak 1 of 1																		
Peak Hour for Entire Intersection Begins at 05:00 PM																		
05:00 PM	0	0	0	0	0	0	0	0	0	0	0	1	1	0	0	0	0	1
05:15 PM	0	0	0	0	0	0	0	0	0	0	0	4	4	0	0	0	0	4
05:30 PM	0	0	0	0	0	0	0	0	0	0	0	2	2	0	0	0	0	2
05:45 PM	0	0	0	0	0	0	0	0	0	0	0	2	2	0	0	0	0	2
Total Volume	0	0	0	0	0	0	0	0	0	0	0	9	9	0	0	0	0	9
% App. Total	0	0	0	0	0	0	0	0	0	0	0	100	100	0	0	0	0	0
PHF	.000	.000	.000	.000	.000	.000	.000	.000	.000	.000	.000	.563	.563	.000	.000	.000	.000	.563

Accurate Counts

978-664-2565

N/S Street : Holiday Inn / Newmarket Rd
 E/W Street : Dover Road / Main Street
 City/State : Durham, NH
 Weather : Cloudy

File Name : 100780S1
 Site Code : 10078001
 Start Date : 11/2/2024
 Page No : 1

Groups Printed- Cars - Trucks

Start Time	Holiday Inn Express From North			Dover Rd From East			Newmarket Rd From South			Main St From West			Int. Total
	Left	Thru	Right	Left	Thru	Right	Left	Thru	Right	Left	Thru	Right	
11:00 AM	1	0	1	81	38	0	39	1	85	1	77	34	358
11:15 AM	1	1	2	93	59	1	35	1	91	0	74	35	393
11:30 AM	0	0	0	86	64	1	34	0	93	1	105	46	430
11:45 AM	2	1	2	92	49	1	47	0	87	1	92	53	427
Total	4	2	5	352	210	3	155	2	356	3	348	168	1608
12:00 PM	1	0	1	111	51	0	31	0	85	1	102	34	417
12:15 PM	1	1	3	80	58	1	31	1	95	2	93	40	406
12:30 PM	1	0	0	99	51	0	33	0	101	3	102	51	441
12:45 PM	2	1	1	91	54	1	34	0	80	0	84	93	441
Total	5	2	5	381	214	2	129	1	361	6	381	218	1705
01:00 PM	0	0	5	109	78	0	29	0	78	1	85	42	427
01:15 PM	1	1	4	86	72	0	46	0	77	3	88	35	413
01:30 PM	2	0	2	90	97	1	28	0	91	1	100	29	441
01:45 PM	0	0	0	97	81	0	30	0	85	2	103	38	436
Total	3	1	11	382	328	1	133	0	331	7	376	144	1717
Grand Total	12	5	21	1115	752	6	417	3	1048	16	1105	530	5030
Apprch %	31.6	13.2	55.3	59.5	40.1	0.3	28.4	0.2	71.4	1	66.9	32.1	
Total %	0.2	0.1	0.4	22.2	15	0.1	8.3	0.1	20.8	0.3	22	10.5	
Cars	12	5	21	1109	748	6	409	3	1045	16	1102	522	4998
% Cars	100	100	100	99.5	99.5	100	98.1	100	99.7	100	99.7	98.5	99.4
Trucks	0	0	0	6	4	0	8	0	3	0	3	8	32
% Trucks	0	0	0	0.5	0.5	0	1.9	0	0.3	0	0.3	1.5	0.6

Start Time	Holiday Inn Express From North				Dover Rd From East				Newmarket Rd From South				Main St From West				Int. Total
	Left	Thru	Right	App. Total	Left	Thru	Right	App. Total	Left	Thru	Right	App. Total	Left	Thru	Right	App. Total	
Peak Hour Analysis From 11:00 AM to 01:45 PM - Peak 1 of 1																	
Peak Hour for Entire Intersection Begins at 12:30 PM																	
12:30 PM	1	0	0	1	99	51	0	150	33	0	101	134	3	102	51	156	441
12:45 PM	2	1	1	4	91	54	1	146	34	0	80	114	0	84	93	177	441
01:00 PM	0	0	5	5	109	78	0	187	29	0	78	107	1	85	42	128	427
01:15 PM	1	1	4	6	86	72	0	158	46	0	77	123	3	88	35	126	413
Total Volume	4	2	10	16	385	255	1	641	142	0	336	478	7	359	221	587	1722
% App. Total	25	12.5	62.5		60.1	39.8	0.2		29.7	0	70.3		1.2	61.2	37.6		
PHF	.500	.500	.500	.667	.883	.817	.250	.857	.772	.000	.832	.892	.583	.880	.594	.829	.976
Cars	4	2	10	16	382	253	1	636	137	0	334	471	7	357	218	582	1705
% Cars	100	100	100	100	99.2	99.2	100	99.2	96.5	0	99.4	98.5	100	99.4	98.6	99.1	99.0
Trucks	0	0	0	0	3	2	0	5	5	0	2	7	0	2	3	5	17
% Trucks	0	0	0	0	0.8	0.8	0	0.8	3.5	0	0.6	1.5	0	0.6	1.4	0.9	1.0

Accurate Counts

978-664-2565

N/S Street : Holiday Inn / Newmarket Rd

E/W Street : Dover Road / Main Street

City/State : Durham, NH

Weather : Cloudy

File Name : 100780S1

Site Code : 10078001

Start Date : 11/2/2024

Page No : 2

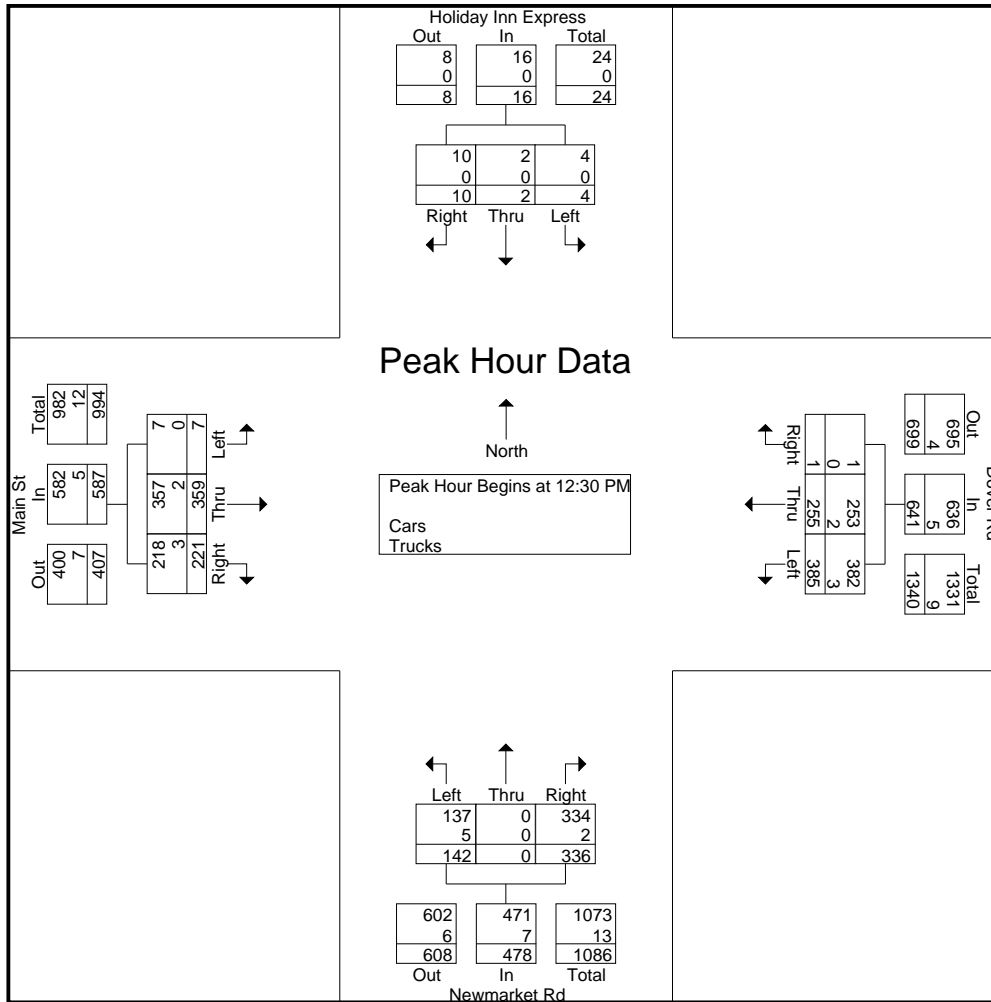

Peak Hour Analysis From 11:00 AM to 01:45 PM - Peak 1 of 1

Peak Hour for Each Approach Begins at:

	12:45 PM				01:00 PM				11:00 AM				12:00 PM			
+0 mins.	2	1	1	4	109	78	0	187	39	1	85	125	1	102	34	137
+15 mins.	0	0	5	5	86	72	0	158	35	1	91	127	2	93	40	135
+30 mins.	1	1	4	6	90	97	1	188	34	0	93	127	3	102	51	156
+45 mins.	2	0	2	4	97	81	0	178	47	0	87	134	0	84	93	177
Total Volume	5	2	12	19	382	328	1	711	155	2	356	513	6	381	218	605
% App. Total	26.3	10.5	63.2		53.7	46.1	0.1		30.2	0.4	69.4		1	63	36	
PHF	.625	.500	.600	.792	.876	.845	.250	.945	.824	.500	.957	.957	.500	.934	.586	.855
Cars	5	2	12	19	380	326	1	707	155	2	356	513	6	380	216	602
% Cars	100	100	100	100	99.5	99.4	100	99.4	100	100	100	100	100	99.7	99.1	99.5
Trucks	0	0	0	0	2	2	0	4	0	0	0	0	0	1	2	3
% Trucks	0	0	0	0	0.5	0.6	0	0.6	0	0	0	0	0	0.3	0.9	0.5

Accurate Counts

978-664-2565

N/S Street : Holiday Inn / Newmarket Rd
 E/W Street : Dover Road / Main Street
 City/State : Durham, NH
 Weather : Cloudy

File Name : 100780S1
 Site Code : 10078001
 Start Date : 11/2/2024
 Page No : 7

Groups Printed- Trucks

Start Time	Holiday Inn Express From North			Dover Rd From East			Newmarket Rd From South			Main St From West			Int. Total
	Left	Thru	Right	Left	Thru	Right	Left	Thru	Right	Left	Thru	Right	
11:00 AM	0	0	0	2	0	0	0	0	0	0	0	1	3
11:15 AM	0	0	0	0	0	0	0	0	0	0	0	0	0
11:30 AM	0	0	0	0	0	0	0	0	0	0	0	0	0
11:45 AM	0	0	0	0	1	0	0	0	0	0	0	2	3
Total	0	0	0	2	1	0	0	0	0	0	0	3	6
12:00 PM	0	0	0	1	0	0	1	0	0	0	0	0	2
12:15 PM	0	0	0	0	0	0	0	0	0	0	0	2	2
12:30 PM	0	0	0	1	0	0	1	0	1	0	0	0	3
12:45 PM	0	0	0	0	1	0	1	0	0	0	1	0	3
Total	0	0	0	2	1	0	3	0	1	0	1	2	10
01:00 PM	0	0	0	2	1	0	2	0	1	0	0	3	9
01:15 PM	0	0	0	0	0	0	1	0	0	0	1	0	2
01:30 PM	0	0	0	0	1	0	0	0	0	0	0	0	1
01:45 PM	0	0	0	0	0	0	2	0	1	0	1	0	4
Total	0	0	0	2	2	0	5	0	2	0	2	3	16
Grand Total	0	0	0	6	4	0	8	0	3	0	3	8	32
Apprch %	0	0	0	60	40	0	72.7	0	27.3	0	27.3	72.7	
Total %	0	0	0	18.8	12.5	0	25	0	9.4	0	9.4	25	

Start Time	Holiday Inn Express From North				Dover Rd From East				Newmarket Rd From South				Main St From West				Int. Total
	Left	Thru	Right	App. Total	Left	Thru	Right	App. Total	Left	Thru	Right	App. Total	Left	Thru	Right	App. Total	
Peak Hour Analysis From 11:00 AM to 01:45 PM - Peak 1 of 1																	
Peak Hour for Entire Intersection Begins at 12:15 PM																	
12:15 PM	0	0	0	0	0	0	0	0	0	0	0	0	0	0	2	2	2
12:30 PM	0	0	0	0	1	0	0	1	1	0	1	2	0	0	0	0	3
12:45 PM	0	0	0	0	0	1	0	1	1	0	0	1	0	1	0	1	3
01:00 PM	0	0	0	0	2	1	0	3	2	0	1	3	0	0	3	3	9
Total Volume	0	0	0	0	3	2	0	5	4	0	2	6	0	1	5	6	17
% App. Total	0	0	0		60	40	0		66.7	0	33.3		0	16.7	83.3		
PHF	.000	.000	.000	.000	.375	.500	.000	.417	.500	.000	.500	.500	.000	.250	.417	.500	.472

Accurate Counts

978-664-2565

N/S Street : Holiday Inn / Newmarket Rd

E/W Street : Dover Road / Main Street

City/State : Durham, NH

Weather : Cloudy

File Name : 100780S1

Site Code : 10078001

Start Date : 11/2/2024

Page No : 10

Groups Printed- Bikes Peds

Start Time	Holiday Inn Express From North				Dover Rd From East				Newmarket Rd From South				Main St From West				Exclu. Total	Inclu. Total	Int. Total	
	Left	Thru	Right	Peds	Left	Thru	Right	Peds	Left	Thru	Right	Peds	Left	Thru	Right	Peds				
11:00 AM	0	0	0	0	1	0	0	0	0	0	0	0	5	0	0	0	0	5	1	6
11:15 AM	0	0	0	0	0	1	0	0	0	0	0	0	0	0	0	0	0	0	1	1
11:30 AM	0	0	0	1	0	0	0	0	0	0	0	2	0	0	0	0	3	0	0	3
11:45 AM	0	0	0	0	0	0	0	0	0	0	1	2	0	0	0	0	2	1	0	3
Total	0	0	0	1	1	1	0	0	0	0	1	9	0	0	0	0	10	3	0	13
12:00 PM	0	0	0	0	0	0	0	2	0	0	1	0	0	0	0	0	2	1	0	3
12:15 PM	0	0	0	0	0	0	0	0	0	0	0	0	0	0	0	0	0	0	0	0
12:30 PM	0	0	0	2	0	0	0	3	0	0	0	0	0	0	0	0	5	0	0	5
12:45 PM	0	0	0	2	0	0	0	4	0	0	0	0	0	0	0	0	6	0	0	6
Total	0	0	0	4	0	0	0	9	0	0	1	0	0	0	0	0	13	1	0	14
01:00 PM	0	0	0	0	0	0	0	0	0	0	0	0	0	0	0	0	0	0	0	0
01:15 PM	0	0	0	1	0	0	0	2	0	0	0	1	0	1	0	0	4	1	0	5
01:30 PM	0	0	0	3	0	0	0	4	0	0	0	0	0	0	0	0	7	0	0	7
01:45 PM	0	0	0	1	0	1	0	1	0	0	0	0	0	0	0	0	2	1	0	3
Total	0	0	0	5	0	1	0	7	0	0	0	1	0	1	0	0	13	2	0	15
Grand Total	0	0	0	10	1	2	0	16	0	0	2	10	0	1	0	0	36	6	0	42
Apprch %	0	0	0		33.3	66.7	0		0	0	100		0	100	0					
Total %	0	0	0		16.7	33.3	0		0	0	33.3		0	16.7	0		85.7	14.3		

Start Time	Holiday Inn Express From North				Dover Rd From East				Newmarket Rd From South				Main St From West				Int. Total
	Left	Thru	Right	App. Total	Left	Thru	Right	App. Total	Left	Thru	Right	App. Total	Left	Thru	Right	App. Total	
Peak Hour Analysis From 11:00 AM to 01:45 PM - Peak 1 of 1																	
Peak Hour for Entire Intersection Begins at 11:00 AM																	
11:00 AM	0	0	0	0	1	0	0	1	0	0	0	0	0	0	0	0	1
11:15 AM	0	0	0	0	0	1	0	1	0	0	0	0	0	0	0	0	1
11:30 AM	0	0	0	0	0	0	0	0	0	0	0	0	0	0	0	0	0
11:45 AM	0	0	0	0	0	0	0	0	0	0	1	1	0	0	0	0	1
Total Volume	0	0	0	0	1	1	0	2	0	0	1	1	0	0	0	0	3
% App. Total	0	0	0		50	50	0		0	0	100		0	0	0		
PHF	.000	.000	.000	.000	.250	.250	.000	.500	.000	.000	.250	.250	.000	.000	.000	.000	.750

Accurate Counts

978-664-2565

N/S Street : Holiday Inn / Irving Gas Station
 E/W Street : Dover Road
 City/State : Durham, NH
 Weather : Clear

File Name : 10078003
 Site Code : 10078003
 Start Date : 10/31/2024
 Page No : 1

Groups Printed- Cars - Trucks

Start Time	Holiday Inn Express From North			Dover Rd From East			Irving Gas Station Full Access Dwy From South			Dover Rd From West			Int. Total
	Left	Thru	Right	Left	Thru	Right	Left	Thru	Right	Left	Thru	Right	
07:00 AM	0	0	0	10	102	0	5	0	18	0	98	2	235
07:15 AM	0	0	0	6	104	0	3	0	20	0	120	3	256
07:30 AM	0	0	0	8	144	0	11	0	30	0	163	1	357
07:45 AM	0	0	0	7	185	0	8	0	18	0	182	1	401
Total	0	0	0	31	535	0	27	0	86	0	563	7	1249
08:00 AM	0	0	0	12	155	0	9	0	11	0	141	0	328
08:15 AM	0	0	0	3	137	1	5	0	12	0	125	1	284
08:30 AM	0	0	0	11	152	0	7	0	16	0	141	1	328
08:45 AM	0	0	0	9	135	0	8	0	17	0	109	2	280
Total	0	0	0	35	579	1	29	0	56	0	516	4	1220
Grand Total	0	0	0	66	1114	1	56	0	142	0	1079	11	2469
Apprch %	0	0	0	5.6	94.3	0.1	28.3	0	71.7	0	99	1	
Total %	0	0	0	2.7	45.1	0	2.3	0	5.8	0	43.7	0.4	
Cars	0	0	0	66	1088	1	56	0	142	0	1055	11	2419
% Cars	0	0	0	100	97.7	100	100	0	100	0	97.8	100	98
Trucks	0	0	0	0	26	0	0	0	0	0	24	0	50
% Trucks	0	0	0	0	2.3	0	0	0	0	0	2.2	0	2

Start Time	Holiday Inn Express From North				Dover Rd From East				Irving Gas Station Full Access Dwy From South				Dover Rd From West				Int. Total
	Left	Thru	Right	App. Total	Left	Thru	Right	App. Total	Left	Thru	Right	App. Total	Left	Thru	Right	App. Total	
Peak Hour Analysis From 07:00 AM to 08:45 AM - Peak 1 of 1																	
Peak Hour for Entire Intersection Begins at 07:30 AM																	
07:30 AM	0	0	0	0	8	144	0	152	11	0	30	41	0	163	1	164	357
07:45 AM	0	0	0	0	7	185	0	192	8	0	18	26	0	182	1	183	401
08:00 AM	0	0	0	0	12	155	0	167	9	0	11	20	0	141	0	141	328
08:15 AM	0	0	0	0	3	137	1	141	5	0	12	17	0	125	1	126	284
Total Volume	0	0	0	0	30	621	1	652	33	0	71	104	0	611	3	614	1370
% App. Total	0	0	0	0	4.6	95.2	0.2		31.7	0	68.3		0	99.5	0.5		
PHF	.000	.000	.000	.000	.625	.839	.250	.849	.750	.000	.592	.634	.000	.839	.750	.839	.854
Cars	0	0	0	0	30	608	1	639	33	0	71	104	0	596	3	599	1342
% Cars	0	0	0	0	100	97.9	100	98.0	100	0	100	100	0	97.5	100	97.6	98.0
Trucks	0	0	0	0	0	13	0	13	0	0	0	0	0	15	0	15	28
% Trucks	0	0	0	0	0	2.1	0	2.0	0	0	0	0	0	2.5	0	2.4	2.0

Accurate Counts

978-664-2565

N/S Street : Holiday Inn / Irving Gas Station

E/W Street : Dover Road

City/State : Durham, NH

Weather : Clear

File Name : 10078003

Site Code : 10078003

Start Date : 10/31/2024

Page No : 2

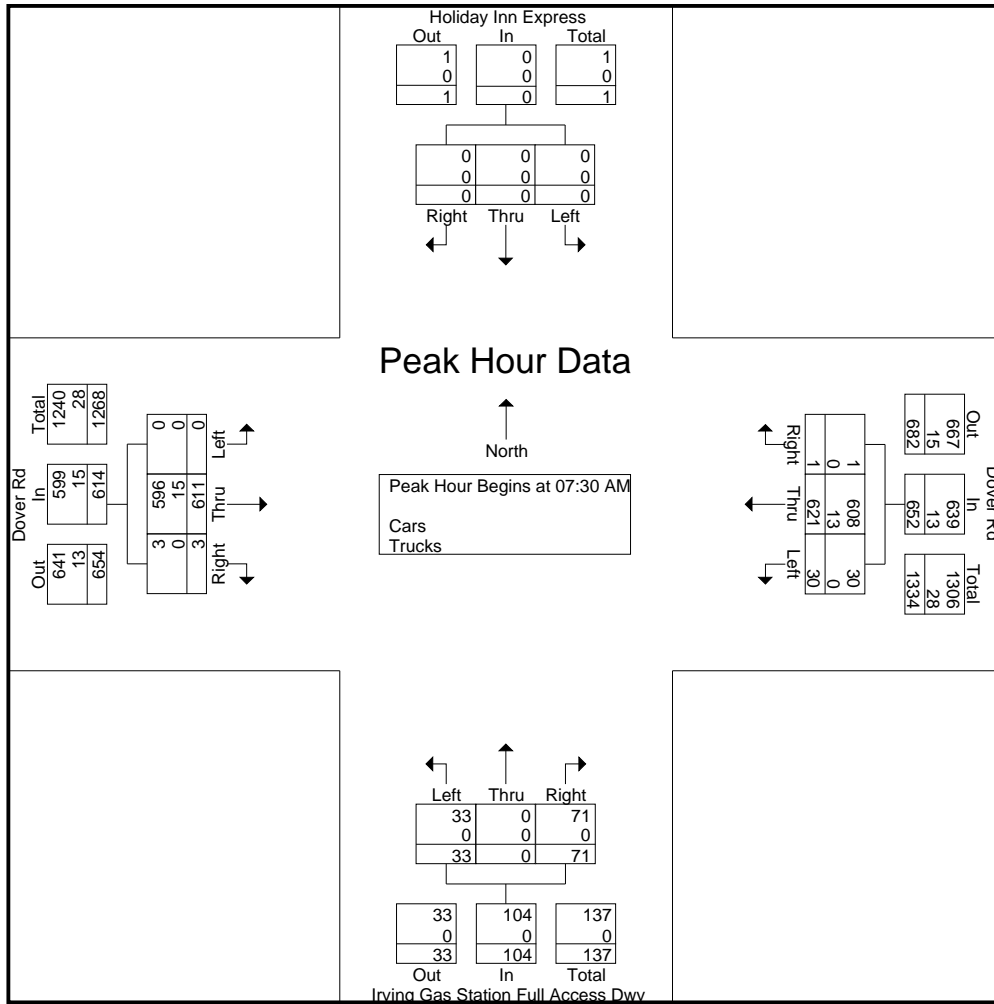

Peak Hour Analysis From 07:00 AM to 08:45 AM - Peak 1 of 1

Peak Hour for Each Approach Begins at:

	07:00 AM				07:45 AM				07:00 AM				07:30 AM			
+0 mins.	0	0	0	0	7	185	0	192	5	0	18	23	0	163	1	164
+15 mins.	0	0	0	0	12	155	0	167	3	0	20	23	0	182	1	183
+30 mins.	0	0	0	0	3	137	1	141	11	0	30	41	0	141	0	141
+45 mins.	0	0	0	0	11	152	0	163	8	0	18	26	0	125	1	126
Total Volume	0	0	0	0	33	629	1	663	27	0	86	113	0	611	3	614
% App. Total	0	0	0	0	5	94.9	0.2		23.9	0	76.1		0	99.5	0.5	
PHF	.000	.000	.000	.000	.688	.850	.250	.863	.614	.000	.717	.689	.000	.839	.750	.839
Cars	0	0	0	0	33	618	1	652	27	0	86	113	0	596	3	599
% Cars	0	0	0	0	100	98.3	100	98.3	100	0	100	100	0	97.5	100	97.6
Trucks	0	0	0	0	0	11	0	11	0	0	0	0	0	15	0	15
% Trucks	0	0	0	0	0	1.7	0	1.7	0	0	0	0	0	2.5	0	2.4

Accurate Counts

978-664-2565

N/S Street : Holiday Inn / Irving Gas Station

E/W Street : Dover Road

City/State : Durham, NH

Weather : Clear

File Name : 10078003

Site Code : 10078003

Start Date : 10/31/2024

Page No : 7

Groups Printed- Trucks

Start Time	Holiday Inn Express From North			Dover Rd From East			Irving Gas Station Full Access Dwy From South			Dover Rd From West			Int. Total
	Left	Thru	Right	Left	Thru	Right	Left	Thru	Right	Left	Thru	Right	
07:00 AM	0	0	0	0	3	0	0	0	0	0	2	0	5
07:15 AM	0	0	0	0	3	0	0	0	0	0	3	0	6
07:30 AM	0	0	0	0	5	0	0	0	0	0	4	0	9
07:45 AM	0	0	0	0	4	0	0	0	0	0	4	0	8
Total	0	0	0	0	15	0	0	0	0	0	13	0	28
08:00 AM	0	0	0	0	2	0	0	0	0	0	4	0	6
08:15 AM	0	0	0	0	2	0	0	0	0	0	3	0	5
08:30 AM	0	0	0	0	3	0	0	0	0	0	1	0	4
08:45 AM	0	0	0	0	4	0	0	0	0	0	3	0	7
Total	0	0	0	0	11	0	0	0	0	0	11	0	22
Grand Total	0	0	0	0	26	0	0	0	0	0	24	0	50
Apprch %	0	0	0	0	100	0	0	0	0	0	100	0	
Total %	0	0	0	0	52	0	0	0	0	0	48	0	

Start Time	Holiday Inn Express From North				Dover Rd From East				Irving Gas Station Full Access Dwy From South				Dover Rd From West				Int. Total
	Left	Thru	Right	App. Total	Left	Thru	Right	App. Total	Left	Thru	Right	App. Total	Left	Thru	Right	App. Total	
Peak Hour Analysis From 07:00 AM to 08:45 AM - Peak 1 of 1																	
Peak Hour for Entire Intersection Begins at 07:15 AM																	
07:15 AM	0	0	0	0	0	3	0	3	0	0	0	0	0	3	0	3	6
07:30 AM	0	0	0	0	0	5	0	5	0	0	0	0	0	4	0	4	9
07:45 AM	0	0	0	0	0	4	0	4	0	0	0	0	0	4	0	4	8
08:00 AM	0	0	0	0	0	2	0	2	0	0	0	0	0	4	0	4	6
Total Volume	0	0	0	0	0	14	0	14	0	0	0	0	0	15	0	15	29
% App. Total	0	0	0	0	0	100	0	100	0	0	0	0	0	100	0	100	
PHF	.000	.000	.000	.000	.000	.700	.000	.700	.000	.000	.000	.000	.000	.938	.000	.938	.806

Accurate Counts

978-664-2565

N/S Street : Holiday Inn / Irving Gas Station

E/W Street : Dover Road

City/State : Durham, NH

Weather : Clear

File Name : 10078003

Site Code : 10078003

Start Date : 10/31/2024

Page No : 10

Groups Printed- Bikes Peds

Start Time	Holiday Inn Express From North				Dover Rd From East				Irving Gas Station Full Access Dwy From South				Dover Rd From West				Exclu. Total	Inclu. Total	Int. Total
	Left	Thru	Right	Peds	Left	Thru	Right	Peds	Left	Thru	Right	Peds	Left	Thru	Right	Peds			
07:00 AM	0	0	0	0	0	0	0	0	0	0	0	0	0	0	0	0	0	0	0
07:15 AM	0	0	0	0	0	0	0	0	0	0	0	0	0	0	0	0	0	0	0
07:30 AM	0	0	0	0	0	0	0	0	0	0	0	1	0	0	0	0	1	0	1
07:45 AM	0	0	0	0	0	0	0	0	3	0	0	1	0	0	0	0	1	3	4
Total	0	0	0	0	0	0	0	0	3	0	0	2	0	0	0	0	2	3	5
08:00 AM	0	0	0	0	0	0	0	0	0	0	0	0	0	0	0	0	0	0	0
08:15 AM	0	0	0	3	0	2	0	0	0	0	0	1	0	0	0	0	4	2	6
08:30 AM	0	0	0	2	0	1	0	0	0	0	0	2	0	1	0	0	4	2	6
08:45 AM	0	0	0	0	0	0	0	0	0	0	0	1	0	0	0	0	1	0	1
Total	0	0	0	5	0	3	0	0	0	0	0	4	0	1	0	0	9	4	13
Grand Total	0	0	0	5	0	3	0	0	3	0	0	6	0	1	0	0	11	7	18
Apprch %	0	0	0		0	100	0		100	0	0		0	100	0				
Total %	0	0	0		0	42.9	0		42.9	0	0		0	14.3	0		61.1	38.9	

Start Time	Holiday Inn Express From North				Dover Rd From East				Irving Gas Station Full Access Dwy From South				Dover Rd From West				Int. Total
	Left	Thru	Right	App. Total	Left	Thru	Right	App. Total	Left	Thru	Right	App. Total	Left	Thru	Right	App. Total	
Peak Hour Analysis From 07:00 AM to 08:45 AM - Peak 1 of 1																	
Peak Hour for Entire Intersection Begins at 07:45 AM																	
07:45 AM	0	0	0	0	0	0	0	0	3	0	0	3	0	0	0	0	3
08:00 AM	0	0	0	0	0	0	0	0	0	0	0	0	0	0	0	0	0
08:15 AM	0	0	0	0	0	2	0	2	0	0	0	0	0	0	0	0	2
08:30 AM	0	0	0	0	0	1	0	1	0	0	0	0	0	1	0	1	2
Total Volume	0	0	0	0	0	3	0	3	3	0	0	3	0	1	0	1	7
% App. Total	0	0	0		0	100	0		100	0	0		0	100	0		
PHF	.000	.000	.000	.000	.000	.375	.000	.375	.250	.000	.000	.250	.000	.250	.000	.250	.583

Accurate Counts

978-664-2565

N/S Street : Holiday Inn / Irving Gas Station

E/W Street : Dover Road

City/State : Durham, NH

Weather : Clear

File Name : 10078003

Site Code : 10078003

Start Date : 10/31/2024

Page No : 1

Groups Printed- Cars - Trucks

Start Time	Holiday Inn Express From North			Dover Rd From East			Irving Gas Station Full Access Dwy From South			Dover Rd From West			Int. Total
	Left	Thru	Right	Left	Thru	Right	Left	Thru	Right	Left	Thru	Right	
03:00 PM	0	0	0	6	161	0	4	0	13	0	168	2	354
03:15 PM	0	0	0	7	183	1	3	0	22	0	161	1	378
03:30 PM	0	0	0	3	177	1	5	1	31	0	185	2	405
03:45 PM	0	0	1	6	150	0	6	0	21	0	171	3	358
Total	0	0	1	22	671	2	18	1	87	0	685	8	1495
04:00 PM	0	0	0	5	145	2	7	0	16	0	168	1	344
04:15 PM	0	0	0	2	141	0	7	0	8	0	115	2	275
04:30 PM	0	0	0	3	134	0	2	0	12	0	102	1	254
04:45 PM	0	0	1	2	141	1	2	0	7	0	140	0	294
Total	0	0	1	12	561	3	18	0	43	0	525	4	1167
05:00 PM	0	0	0	8	188	0	4	0	15	0	211	0	426
05:15 PM	0	0	0	4	165	0	13	0	13	0	192	1	388
05:30 PM	0	0	0	3	191	0	2	0	13	0	156	3	368
05:45 PM	0	0	0	5	161	2	12	0	16	0	145	0	341
Total	0	0	0	20	705	2	31	0	57	0	704	4	1523
Grand Total	0	0	2	54	1937	7	67	1	187	0	1914	16	4185
Apprch %	0	0	100	2.7	96.9	0.4	26.3	0.4	73.3	0	99.2	0.8	
Total %	0	0	0	1.3	46.3	0.2	1.6	0	4.5	0	45.7	0.4	
Cars	0	0	2	54	1919	7	66	1	187	0	1895	16	4147
% Cars	0	0	100	100	99.1	100	98.5	100	100	0	99	100	99.1
Trucks	0	0	0	0	18	0	1	0	0	0	19	0	38
% Trucks	0	0	0	0	0.9	0	1.5	0	0	0	1	0	0.9

Start Time	Holiday Inn Express From North				Dover Rd From East				Irving Gas Station Full Access Dwy From South				Dover Rd From West				Int. Total
	Left	Thru	Right	App. Total	Left	Thru	Right	App. Total	Left	Thru	Right	App. Total	Left	Thru	Right	App. Total	
Peak Hour Analysis From 03:00 PM to 05:45 PM - Peak 1 of 1																	
Peak Hour for Entire Intersection Begins at 05:00 PM																	
05:00 PM	0	0	0	0	8	188	0	196	4	0	15	19	0	211	0	211	426
05:15 PM	0	0	0	0	4	165	0	169	13	0	13	26	0	192	1	193	388
05:30 PM	0	0	0	0	3	191	0	194	2	0	13	15	0	156	3	159	368
05:45 PM	0	0	0	0	5	161	2	168	12	0	16	28	0	145	0	145	341
Total Volume	0	0	0	0	20	705	2	727	31	0	57	88	0	704	4	708	1523
% App. Total	0	0	0	0	2.8	97	0.3		35.2	0	64.8		0	99.4	0.6		
PHF	.000	.000	.000	.000	.625	.923	.250	.927	.596	.000	.891	.786	.000	.834	.333	.839	.894
Cars	0	0	0	0	20	701	2	723	31	0	57	88	0	702	4	706	1517
% Cars	0	0	0	0	100	99.4	100	99.4	100	0	100	100	0	99.7	100	99.7	99.6
Trucks	0	0	0	0	0	4	0	4	0	0	0	0	0	2	0	2	6
% Trucks	0	0	0	0	0	0.6	0	0.6	0	0	0	0	0	0.3	0	0.3	0.4

Accurate Counts

978-664-2565

N/S Street : Holiday Inn / Irving Gas Station

E/W Street : Dover Road

City/State : Durham, NH

Weather : Clear

File Name : 10078003

Site Code : 10078003

Start Date : 10/31/2024

Page No : 2

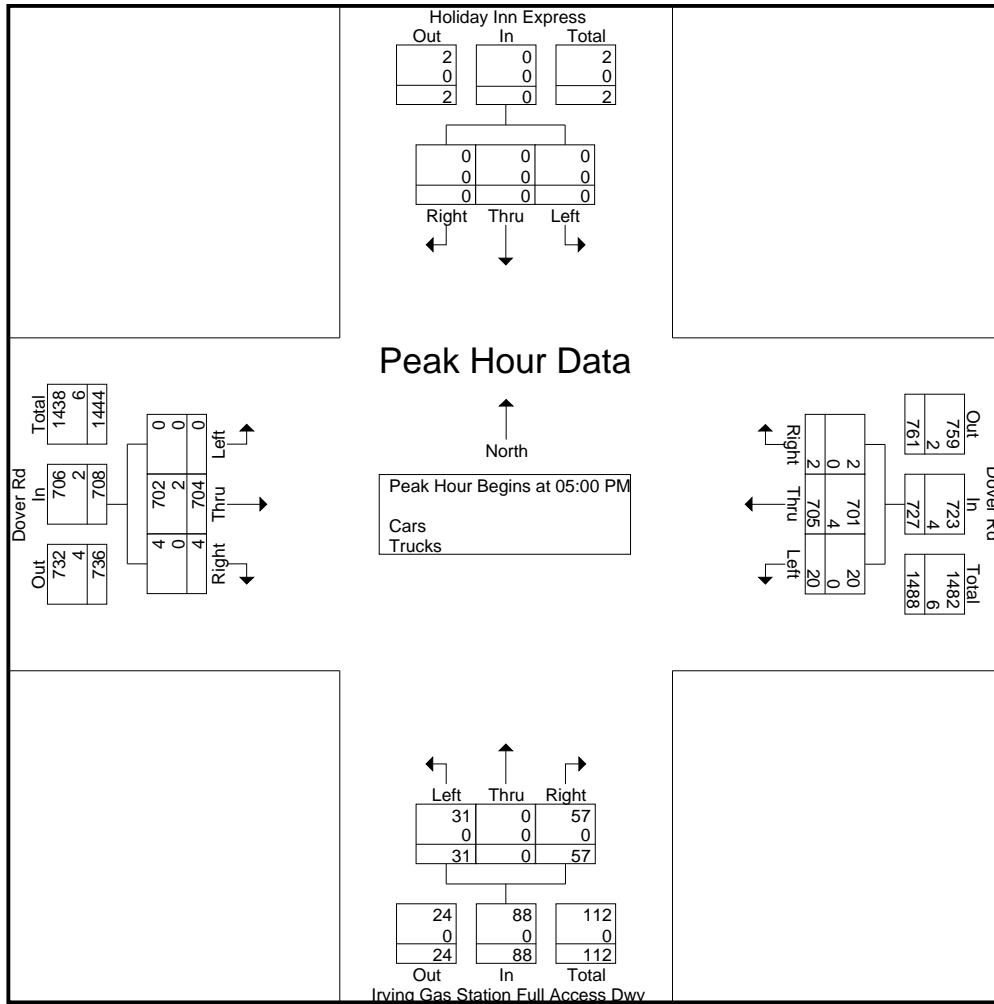

Peak Hour Analysis From 03:00 PM to 05:45 PM - Peak 1 of 1

Peak Hour for Each Approach Begins at:

	03:00 PM				05:00 PM				03:15 PM				05:00 PM			
+0 mins.	0	0	0	0	8	188	0	196	3	0	22	25	0	211	0	211
+15 mins.	0	0	0	0	4	165	0	169	5	1	31	37	0	192	1	193
+30 mins.	0	0	0	0	3	191	0	194	6	0	21	27	0	156	3	159
+45 mins.	0	0	1	1	5	161	2	168	7	0	16	23	0	145	0	145
Total Volume	0	0	1	1	20	705	2	727	21	1	90	112	0	704	4	708
% App. Total	0	0	100		2.8	97	0.3		18.8	0.9	80.4		0	99.4	0.6	
PHF	.000	.000	.250	.250	.625	.923	.250	.927	.750	.250	.726	.757	.000	.834	.333	.839
Cars	0	0	1	1	20	701	2	723	20	1	90	111	0	702	4	706
% Cars	0	0	100	100	100	99.4	100	99.4	95.2	100	100	99.1	0	99.7	100	99.7
Trucks	0	0	0	0	0	4	0	4	1	0	0	1	0	2	0	2
% Trucks	0	0	0	0	0	0.6	0	0.6	4.8	0	0	0.9	0	0.3	0	0.3

Accurate Counts

978-664-2565

N/S Street : Holiday Inn / Irving Gas Station
 E/W Street : Dover Road
 City/State : Durham, NH
 Weather : Clear

File Name : 10078003
 Site Code : 10078003
 Start Date : 10/31/2024
 Page No : 7

Groups Printed- Trucks

Start Time	Holiday Inn Express From North			Dover Rd From East			Irving Gas Station Full Access Dwy From South			Dover Rd From West			Int. Total
	Left	Thru	Right	Left	Thru	Right	Left	Thru	Right	Left	Thru	Right	
03:00 PM	0	0	0	0	4	0	0	0	0	0	5	0	9
03:15 PM	0	0	0	0	3	0	0	0	0	0	2	0	5
03:30 PM	0	0	0	0	2	0	0	0	0	0	1	0	3
03:45 PM	0	0	0	0	2	0	1	0	0	0	6	0	9
Total	0	0	0	0	11	0	1	0	0	0	14	0	26
04:00 PM	0	0	0	0	0	0	0	0	0	0	0	0	0
04:15 PM	0	0	0	0	1	0	0	0	0	0	2	0	3
04:30 PM	0	0	0	0	0	0	0	0	0	0	0	0	0
04:45 PM	0	0	0	0	2	0	0	0	0	0	1	0	3
Total	0	0	0	0	3	0	0	0	0	0	3	0	6
05:00 PM	0	0	0	0	0	0	0	0	0	0	0	0	0
05:15 PM	0	0	0	0	0	0	0	0	0	0	2	0	2
05:30 PM	0	0	0	0	1	0	0	0	0	0	0	0	1
05:45 PM	0	0	0	0	3	0	0	0	0	0	0	0	3
Total	0	0	0	0	4	0	0	0	0	0	2	0	6
Grand Total	0	0	0	0	18	0	1	0	0	0	19	0	38
Apprch %	0	0	0	0	100	0	100	0	0	0	100	0	
Total %	0	0	0	0	47.4	0	2.6	0	0	0	50	0	

Start Time	Holiday Inn Express From North				Dover Rd From East				Irving Gas Station Full Access Dwy From South				Dover Rd From West				Int. Total
	Left	Thru	Right	App. Total	Left	Thru	Right	App. Total	Left	Thru	Right	App. Total	Left	Thru	Right	App. Total	
Peak Hour Analysis From 03:00 PM to 05:45 PM - Peak 1 of 1																	
Peak Hour for Entire Intersection Begins at 03:00 PM																	
03:00 PM	0	0	0	0	0	4	0	4	0	0	0	0	0	5	0	5	9
03:15 PM	0	0	0	0	0	3	0	3	0	0	0	0	0	2	0	2	5
03:30 PM	0	0	0	0	0	2	0	2	0	0	0	0	0	1	0	1	3
03:45 PM	0	0	0	0	0	2	0	2	1	0	0	1	0	6	0	6	9
Total Volume	0	0	0	0	0	11	0	11	1	0	0	1	0	14	0	14	26
% App. Total	0	0	0	0	0	100	0	100	100	0	0	0	0	100	0	100	
PHF	.000	.000	.000	.000	.000	.688	.000	.688	.250	.000	.000	.250	.000	.583	.000	.583	.722

Accurate Counts

978-664-2565

N/S Street : Holiday Inn / Irving Gas Station
 E/W Street : Dover Road
 City/State : Durham, NH
 Weather : Clear

File Name : 10078003
 Site Code : 10078003
 Start Date : 10/31/2024
 Page No : 10

Groups Printed- Bikes Peds

Start Time	Holiday Inn Express From North				Dover Rd From East				Irving Gas Station Full Access Dwy From South				Dover Rd From West				Exclu. Total	Inclu. Total	Int. Total
	Left	Thru	Right	Peds	Left	Thru	Right	Peds	Left	Thru	Right	Peds	Left	Thru	Right	Peds			
03:00 PM	0	0	0	0	0	1	0	1	0	0	0	0	0	0	0	0	1	1	2
03:15 PM	0	0	0	0	0	0	0	0	0	0	0	0	0	0	0	0	0	0	0
03:30 PM	0	0	0	4	0	0	0	0	0	0	0	0	0	0	0	0	4	0	4
03:45 PM	0	0	0	2	0	1	0	0	0	0	0	1	0	2	0	0	3	3	6
Total	0	0	0	6	0	2	0	1	0	0	0	1	0	2	0	0	8	4	12
04:00 PM	0	0	0	0	0	0	0	0	0	0	0	1	0	1	0	0	1	1	2
04:15 PM	0	0	0	1	0	0	0	0	0	0	0	0	0	0	0	0	1	0	1
04:30 PM	0	0	0	3	0	0	0	0	0	0	0	0	0	0	0	0	3	0	3
04:45 PM	0	0	0	0	0	2	0	0	0	0	0	0	0	0	0	0	0	2	2
Total	0	0	0	4	0	2	0	0	0	0	0	1	0	1	0	0	5	3	8
05:00 PM	0	0	0	2	0	0	0	0	0	0	0	3	0	1	0	0	5	1	6
05:15 PM	0	0	0	1	0	0	0	0	0	0	0	4	0	0	0	0	5	0	5
05:30 PM	0	0	0	0	0	1	0	0	0	0	0	3	0	0	0	0	3	1	4
05:45 PM	0	0	0	2	0	0	0	0	0	0	0	2	0	0	0	0	4	0	4
Total	0	0	0	5	0	1	0	0	0	0	0	12	0	1	0	0	17	2	19
Grand Total	0	0	0	15	0	5	0	1	0	0	0	14	0	4	0	0	30	9	39
Apprch %	0	0	0		0	100	0		0	0	0		0	100	0				
Total %	0	0	0		0	55.6	0		0	0	0		0	44.4	0		76.9	23.1	

Start Time	Holiday Inn Express From North				Dover Rd From East				Irving Gas Station Full Access Dwy From South				Dover Rd From West				Int. Total
	Left	Thru	Right	App. Total	Left	Thru	Right	App. Total	Left	Thru	Right	App. Total	Left	Thru	Right	App. Total	
Peak Hour Analysis From 03:00 PM to 05:45 PM - Peak 1 of 1																	
Peak Hour for Entire Intersection Begins at 03:00 PM																	
03:00 PM	0	0	0	0	0	1	0	1	0	0	0	0	0	0	0	0	1
03:15 PM	0	0	0	0	0	0	0	0	0	0	0	0	0	0	0	0	0
03:30 PM	0	0	0	0	0	0	0	0	0	0	0	0	0	0	0	0	0
03:45 PM	0	0	0	0	0	1	0	1	0	0	0	0	0	2	0	2	3
Total Volume	0	0	0	0	0	2	0	2	0	0	0	0	0	2	0	2	4
% App. Total	0	0	0	0	0	100	0	0	0	0	0	0	0	100	0	0	0
PHF	.000	.000	.000	.000	.000	.500	.000	.500	.000	.000	.000	.000	.000	.250	.000	.250	.333

Accurate Counts

978-664-2565

N/S Street : Holiday Inn / Irving Gas Station

E/W Street : Dover Road

City/State : Durham, NH

Weather : Cloudy

File Name : 100780S3

Site Code : 10078003

Start Date : 11/2/2024

Page No : 1

Groups Printed- Cars - Trucks

Start Time	Holiday Inn Express From North			Dover Rd From East			Irving Gas Station Full Access Dwy From South			Dover Rd From West			Int. Total
	Left	Thru	Right	Left	Thru	Right	Left	Thru	Right	Left	Thru	Right	
11:00 AM	1	0	0	4	118	0	11	0	16	0	148	4	302
11:15 AM	0	0	0	3	134	1	13	0	12	0	152	1	316
11:30 AM	0	0	0	6	145	1	6	0	13	0	174	4	349
11:45 AM	0	0	0	7	131	0	11	0	14	0	157	3	323
Total	1	0	0	20	528	2	41	0	55	0	631	12	1290
12:00 PM	1	0	1	7	147	0	15	0	14	0	167	1	353
12:15 PM	0	1	0	6	133	1	8	0	19	0	160	5	333
12:30 PM	0	0	0	3	137	0	13	1	15	1	180	4	354
12:45 PM	0	0	0	4	140	0	3	0	21	0	141	1	310
Total	1	1	1	20	557	1	39	1	69	1	648	11	1350
01:00 PM	1	0	1	7	176	0	12	0	24	0	141	0	362
01:15 PM	0	0	0	2	149	0	19	0	18	0	143	3	334
01:30 PM	0	0	1	7	172	1	9	0	19	0	179	1	389
01:45 PM	0	0	0	9	169	1	8	0	12	0	165	0	364
Total	1	0	2	25	666	2	48	0	73	0	628	4	1449
Grand Total	3	1	3	65	1751	5	128	1	197	1	1907	27	4089
Apprch %	42.9	14.3	42.9	3.6	96.2	0.3	39.3	0.3	60.4	0.1	98.6	1.4	
Total %	0.1	0	0.1	1.6	42.8	0.1	3.1	0	4.8	0	46.6	0.7	
Cars	3	1	3	65	1742	5	128	1	197	1	1903	27	4076
% Cars	100	100	100	100	99.5	100	100	100	100	100	99.8	100	99.7
Trucks	0	0	0	0	9	0	0	0	0	0	4	0	13
% Trucks	0	0	0	0	0.5	0	0	0	0	0	0.2	0	0.3

Start Time	Holiday Inn Express From North				Dover Rd From East				Irving Gas Station Full Access Dwy From South				Dover Rd From West				Int. Total
	Left	Thru	Right	App. Total	Left	Thru	Right	App. Total	Left	Thru	Right	App. Total	Left	Thru	Right	App. Total	
Peak Hour Analysis From 11:00 AM to 01:45 PM - Peak 1 of 1																	
Peak Hour for Entire Intersection Begins at 01:00 PM																	
01:00 PM	1	0	1	2	7	176	0	183	12	0	24	36	0	141	0	141	362
01:15 PM	0	0	0	0	2	149	0	151	19	0	18	37	0	143	3	146	334
01:30 PM	0	0	1	1	7	172	1	180	9	0	19	28	0	179	1	180	389
01:45 PM	0	0	0	0	9	169	1	179	8	0	12	20	0	165	0	165	364
Total Volume	1	0	2	3	25	666	2	693	48	0	73	121	0	628	4	632	1449
% App. Total	33.3	0	66.7		3.6	96.1	0.3		39.7	0	60.3		0	99.4	0.6		
PHF	.250	.000	.500	.375	.694	.946	.500	.947	.632	.000	.760	.818	.000	.877	.333	.878	.931
Cars	1	0	2	3	25	663	2	690	48	0	73	121	0	627	4	631	1445
% Cars	100	0	100	100	100	99.5	100	99.6	100	0	100	100	0	99.8	100	99.8	99.7
Trucks	0	0	0	0	0	3	0	3	0	0	0	0	0	1	0	1	4
% Trucks	0	0	0	0	0	0.5	0	0.4	0	0	0	0	0	0.2	0	0.2	0.3

Accurate Counts

978-664-2565

N/S Street : Holiday Inn / Irving Gas Station

E/W Street : Dover Road

City/State : Durham, NH

Weather : Cloudy

File Name : 100780S3

Site Code : 10078003

Start Date : 11/2/2024

Page No : 2

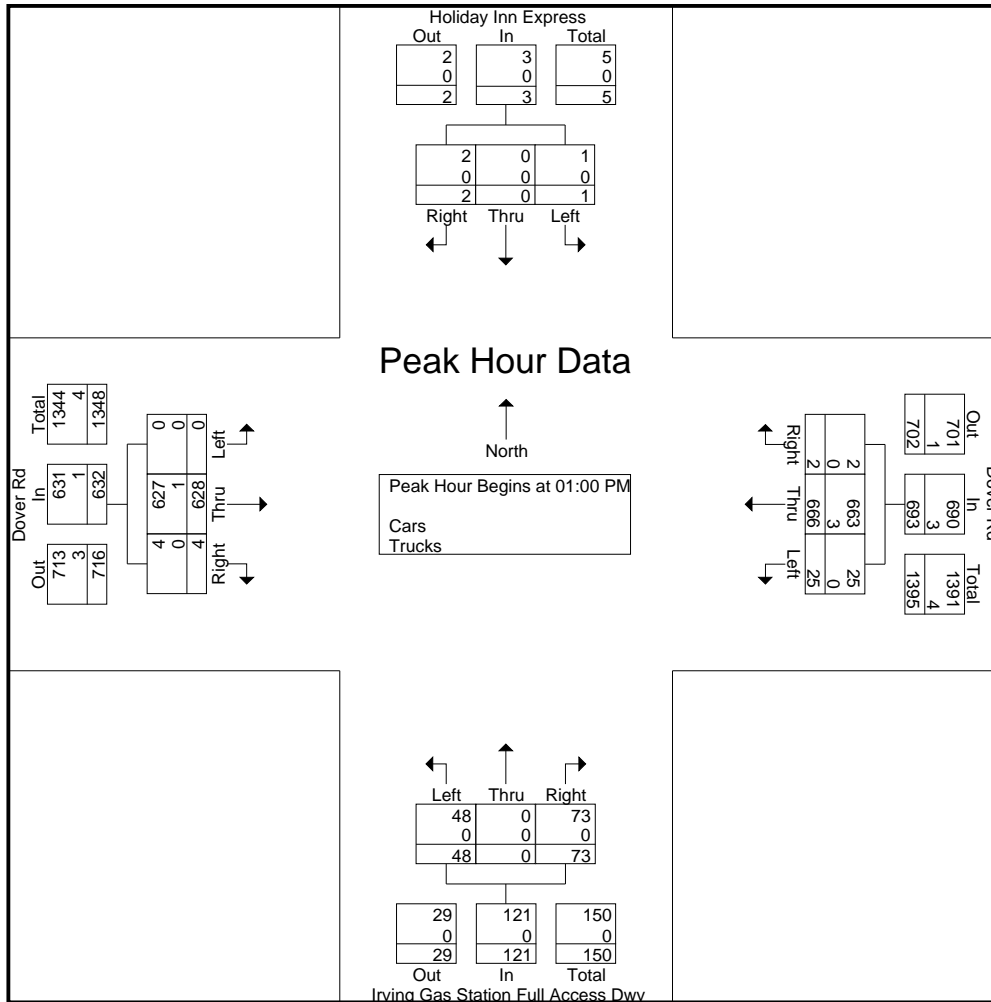

Peak Hour Analysis From 11:00 AM to 01:45 PM - Peak 1 of 1

Peak Hour for Each Approach Begins at:

	11:30 AM				01:00 PM				12:30 PM				11:45 AM			
+0 mins.	0	0	0	0	7	176	0	183	13	1	15	29	0	157	3	160
+15 mins.	0	0	0	0	2	149	0	151	3	0	21	24	0	167	1	168
+30 mins.	1	0	1	2	7	172	1	180	12	0	24	36	0	160	5	165
+45 mins.	0	1	0	1	9	169	1	179	19	0	18	37	1	180	4	185
Total Volume	1	1	1	3	25	666	2	693	47	1	78	126	1	664	13	678
% App. Total	33.3	33.3	33.3		3.6	96.1	0.3		37.3	0.8	61.9		0.1	97.9	1.9	
PHF	.250	.250	.250	.375	.694	.946	.500	.947	.618	.250	.813	.851	.250	.922	.650	.916
Cars	1	1	1	3	25	663	2	690	47	1	78	126	1	661	13	675
% Cars	100	100	100	100	100	99.5	100	99.6	100	100	100	100	100	99.5	100	99.6
Trucks	0	0	0	0	0	3	0	3	0	0	0	0	0	3	0	3
% Trucks	0	0	0	0	0	0.5	0	0.4	0	0	0	0	0	0.5	0	0.4

Accurate Counts

978-664-2565

N/S Street : Holiday Inn / Irving Gas Station
 E/W Street : Dover Road
 City/State : Durham, NH
 Weather : Cloudy

File Name : 100780S3
 Site Code : 10078003
 Start Date : 11/2/2024
 Page No : 7

Groups Printed- Trucks

Start Time	Holiday Inn Express From North			Dover Rd From East			Irving Gas Station Full Access Dwy From South			Dover Rd From West			Int. Total
	Left	Thru	Right	Left	Thru	Right	Left	Thru	Right	Left	Thru	Right	
11:00 AM	0	0	0	0	2	0	0	0	0	0	0	0	2
11:15 AM	0	0	0	0	0	0	0	0	0	0	0	0	0
11:30 AM	0	0	0	0	0	0	0	0	0	0	0	0	0
11:45 AM	0	0	0	0	1	0	0	0	0	0	1	0	2
Total	0	0	0	0	3	0	0	0	0	0	1	0	4
12:00 PM	0	0	0	0	1	0	0	0	0	0	0	0	1
12:15 PM	0	0	0	0	0	0	0	0	0	0	1	0	1
12:30 PM	0	0	0	0	0	0	0	0	0	0	1	0	1
12:45 PM	0	0	0	0	2	0	0	0	0	0	0	0	2
Total	0	0	0	0	3	0	0	0	0	0	2	0	5
01:00 PM	0	0	0	0	2	0	0	0	0	0	0	0	2
01:15 PM	0	0	0	0	0	0	0	0	0	0	1	0	1
01:30 PM	0	0	0	0	1	0	0	0	0	0	0	0	1
01:45 PM	0	0	0	0	0	0	0	0	0	0	0	0	0
Total	0	0	0	0	3	0	0	0	0	0	1	0	4
Grand Total	0	0	0	0	9	0	0	0	0	0	4	0	13
Apprch %	0	0	0	0	100	0	0	0	0	0	100	0	
Total %	0	0	0	0	69.2	0	0	0	0	0	30.8	0	

Start Time	Holiday Inn Express From North				Dover Rd From East				Irving Gas Station Full Access Dwy From South				Dover Rd From West				Int. Total
	Left	Thru	Right	App. Total	Left	Thru	Right	App. Total	Left	Thru	Right	App. Total	Left	Thru	Right	App. Total	
Peak Hour Analysis From 11:00 AM to 01:45 PM - Peak 1 of 1																	
Peak Hour for Entire Intersection Begins at 12:15 PM																	
12:15 PM	0	0	0	0	0	0	0	0	0	0	0	0	0	1	0	1	
12:30 PM	0	0	0	0	0	0	0	0	0	0	0	0	0	1	0	1	
12:45 PM	0	0	0	0	0	2	0	2	0	0	0	0	0	0	0	2	
01:00 PM	0	0	0	0	0	2	0	2	0	0	0	0	0	0	0	2	
Total Volume	0	0	0	0	0	4	0	4	0	0	0	0	0	2	0	6	
% App. Total	0	0	0	0	0	100	0	0	0	0	0	0	0	100	0	0	
PHF	.000	.000	.000	.000	.000	.500	.000	.500	.000	.000	.000	.000	.000	.500	.000	.750	

Accurate Counts

978-664-2565

N/S Street : Holiday Inn / Irving Gas Station
 E/W Street : Dover Road
 City/State : Durham, NH
 Weather : Cloudy

File Name : 100780S3
 Site Code : 10078003
 Start Date : 11/2/2024
 Page No : 10

Groups Printed- Bikes Peds

Start Time	Holiday Inn Express From North				Dover Rd From East				Irving Gas Station Full Access Dwy From South				Dover Rd From West				Exclu. Total	Inclu. Total	Int. Total
	Left	Thru	Right	Peds	Left	Thru	Right	Peds	Left	Thru	Right	Peds	Left	Thru	Right	Peds			
11:00 AM	0	0	0	0	0	2	0	0	0	0	0	0	0	1	0	2	2	3	5
11:15 AM	0	0	0	0	0	0	0	2	0	0	0	0	0	0	0	0	2	0	2
11:30 AM	0	0	0	1	0	0	0	2	0	0	0	0	0	0	0	0	3	0	3
11:45 AM	0	0	0	0	0	0	0	0	0	0	0	1	0	1	0	0	1	1	2
Total	0	0	0	1	0	2	0	4	0	0	0	1	0	2	0	2	8	4	12
12:00 PM	0	0	0	0	0	0	0	0	0	0	0	0	0	1	0	0	0	1	1
12:15 PM	0	0	0	2	0	0	0	0	0	0	0	0	0	0	0	0	2	0	2
12:30 PM	0	0	0	1	0	0	0	0	0	0	0	1	0	0	0	0	2	0	2
12:45 PM	0	0	0	1	0	0	0	0	0	0	0	0	0	0	0	0	1	0	1
Total	0	0	0	4	0	0	0	0	0	0	0	1	0	1	0	0	5	1	6
01:00 PM	0	0	0	0	0	0	0	0	0	0	0	0	0	0	0	0	0	0	0
01:15 PM	0	0	0	0	0	0	0	0	0	0	0	0	0	2	0	0	0	2	2
01:30 PM	0	0	0	4	0	0	0	0	0	0	0	2	0	0	0	2	8	0	8
01:45 PM	0	0	0	1	0	1	0	0	0	0	0	0	0	0	0	0	1	1	2
Total	0	0	0	5	0	1	0	0	0	0	0	2	0	2	0	2	9	3	12
Grand Total	0	0	0	10	0	3	0	4	0	0	0	4	0	5	0	4	22	8	30
Apprch %	0	0	0		0	100	0		0	0	0		0	100	0				
Total %	0	0	0		0	37.5	0		0	0	0		0	62.5	0		73.3	26.7	

Start Time	Holiday Inn Express From North				Dover Rd From East				Irving Gas Station Full Access Dwy From South				Dover Rd From West				Int. Total
	Left	Thru	Right	App. Total	Left	Thru	Right	App. Total	Left	Thru	Right	App. Total	Left	Thru	Right	App. Total	
Peak Hour Analysis From 11:00 AM to 01:45 PM - Peak 1 of 1																	
Peak Hour for Entire Intersection Begins at 11:00 AM																	
11:00 AM	0	0	0	0	0	2	0	2	0	0	0	0	0	1	0	1	3
11:15 AM	0	0	0	0	0	0	0	0	0	0	0	0	0	0	0	0	0
11:30 AM	0	0	0	0	0	0	0	0	0	0	0	0	0	0	0	0	0
11:45 AM	0	0	0	0	0	0	0	0	0	0	0	0	0	1	0	1	1
Total Volume	0	0	0	0	0	2	0	2	0	0	0	0	0	2	0	2	4
% App. Total	0	0	0		0	100	0		0	0	0		0	100	0		
PHF	.000	.000	.000	.000	.000	.250	.000	.250	.000	.000	.000	.000	.000	.500	.000	.500	.333

Accurate Counts

978-664-2565

N/S Street : 3 Dover Road
 E/W Street : Dover Road
 City/State : Durham, NH
 Weather : Clear

File Name : 10078004
 Site Code : 10078004
 Start Date : 10/31/2024
 Page No : 1

Groups Printed- Cars - Trucks

Start Time	3 Dover Rd From North		Dover Rd From East		Dover Rd From West		Int. Total
	Left	Right	Thru	Right	Left	Thru	
07:00 AM	0	0	112	1	0	117	230
07:15 AM	0	1	110	0	0	139	250
07:30 AM	0	0	159	0	0	190	349
07:45 AM	0	0	188	0	0	200	388
Total	0	1	569	1	0	646	1217
08:00 AM	0	0	168	0	0	152	320
08:15 AM	0	0	141	0	0	138	279
08:30 AM	0	0	161	0	0	158	319
08:45 AM	0	0	144	0	0	126	270
Total	0	0	614	0	0	574	1188
Grand Total	0	1	1183	1	0	1220	2405
Apprch %	0	100	99.9	0.1	0	100	
Total %	0	0	49.2	0	0	50.7	
Cars	0	1	1157	1	0	1194	2353
% Cars	0	100	97.8	100	0	97.9	97.8
Trucks	0	0	26	0	0	26	52
% Trucks	0	0	2.2	0	0	2.1	2.2

Start Time	3 Dover Rd From North			Dover Rd From East			Dover Rd From West			Int. Total
	Left	Right	App. Total	Thru	Right	App. Total	Left	Thru	App. Total	
Peak Hour Analysis From 07:00 AM to 08:45 AM - Peak 1 of 1										
Peak Hour for Entire Intersection Begins at 07:30 AM										
07:30 AM	0	0	0	159	0	159	0	190	190	349
07:45 AM	0	0	0	188	0	188	0	200	200	388
08:00 AM	0	0	0	168	0	168	0	152	152	320
08:15 AM	0	0	0	141	0	141	0	138	138	279
Total Volume	0	0	0	656	0	656	0	680	680	1336
% App. Total	0	0		100	0		0	100		
PHF	.000	.000	.000	.872	.000	.872	.000	.850	.850	.861
Cars	0	0	0	641	0	641	0	664	664	1305
% Cars	0	0	0	97.7	0	97.7	0	97.6	97.6	97.7
Trucks	0	0	0	15	0	15	0	16	16	31
% Trucks	0	0	0	2.3	0	2.3	0	2.4	2.4	2.3

Accurate Counts

978-664-2565

File Name : 10078004

Site Code : 10078004

Start Date : 10/31/2024

Page No : 2

N/S Street : 3 Dover Road

E/W Street : Dover Road

City/State : Durham, NH

Weather : Clear

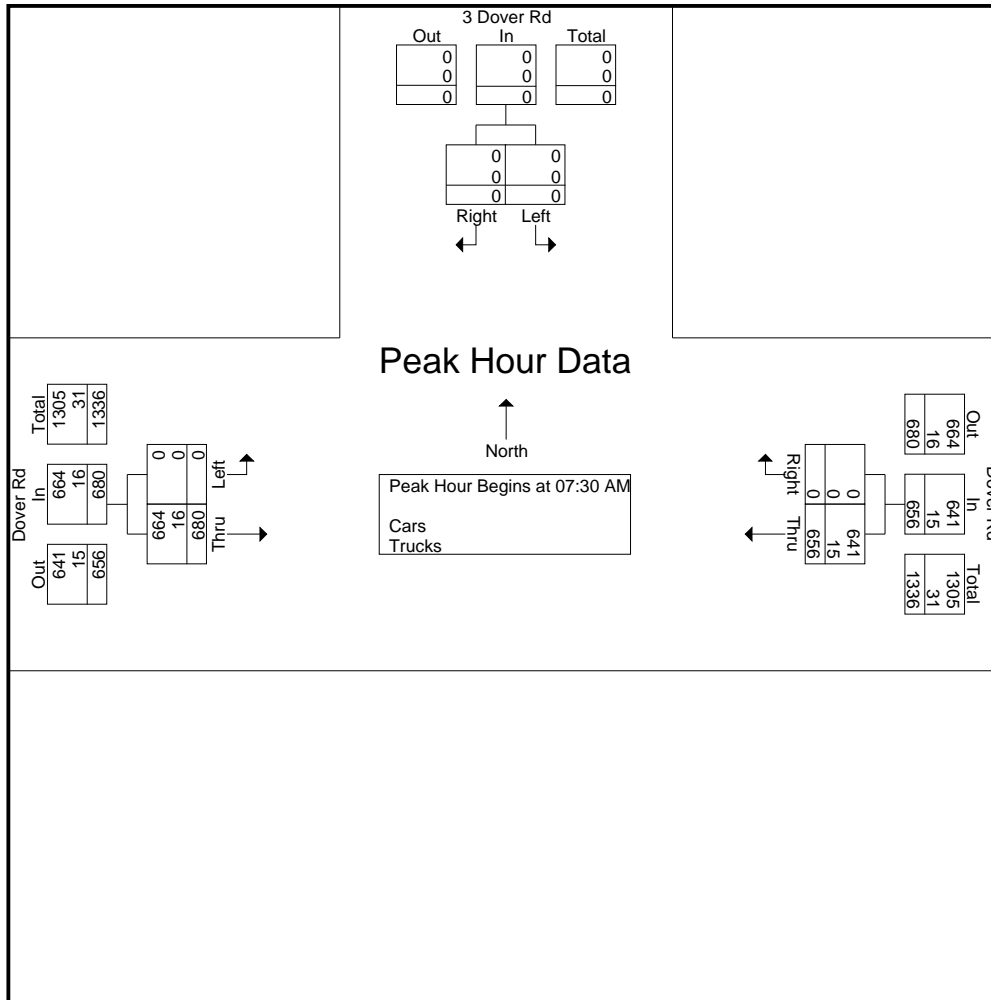

Peak Hour Analysis From 07:00 AM to 08:45 AM - Peak 1 of 1

Peak Hour for Each Approach Begins at:

	07:00 AM			07:45 AM			07:15 AM		
+0 mins.	0	0	0	188	0	188	0	139	139
+15 mins.	0	1	1	168	0	168	0	190	190
+30 mins.	0	0	0	141	0	141	0	200	200
+45 mins.	0	0	0	161	0	161	0	152	152
Total Volume	0	1	1	658	0	658	0	681	681
% App. Total	0	100		100	0		0	100	
PHF	.000	.250	.250	.875	.000	.875	.000	.851	.851
Cars	0	1	1	647	0	647	0	664	664
% Cars	0	100	100	98.3	0	98.3	0	97.5	97.5
Trucks	0	0	0	11	0	11	0	17	17
% Trucks	0	0	0	1.7	0	1.7	0	2.5	2.5

Accurate Counts

978-664-2565

N/S Street : 3 Dover Road
 E/W Street : Dover Road
 City/State : Durham, NH
 Weather : Clear

File Name : 10078004
 Site Code : 10078004
 Start Date : 10/31/2024
 Page No : 7

Groups Printed- Trucks

Start Time	3 Dover Rd From North		Dover Rd From East		Dover Rd From West		Int. Total
	Left	Right	Thru	Right	Left	Thru	
07:00 AM	0	0	2	0	0	1	3
07:15 AM	0	0	3	0	0	4	7
07:30 AM	0	0	7	0	0	5	12
07:45 AM	0	0	4	0	0	4	8
Total	0	0	16	0	0	14	30
08:00 AM	0	0	1	0	0	4	5
08:15 AM	0	0	3	0	0	3	6
08:30 AM	0	0	3	0	0	2	5
08:45 AM	0	0	3	0	0	3	6
Total	0	0	10	0	0	12	22
Grand Total	0	0	26	0	0	26	52
Apprch %	0	0	100	0	0	100	
Total %	0	0	50	0	0	50	

Start Time	3 Dover Rd From North			Dover Rd From East			Dover Rd From West			Int. Total
	Left	Right	App. Total	Thru	Right	App. Total	Left	Thru	App. Total	
Peak Hour Analysis From 07:00 AM to 08:45 AM - Peak 1 of 1										
Peak Hour for Entire Intersection Begins at 07:15 AM										
07:15 AM	0	0	0	3	0	3	0	4	4	7
07:30 AM	0	0	0	7	0	7	0	5	5	12
07:45 AM	0	0	0	4	0	4	0	4	4	8
08:00 AM	0	0	0	1	0	1	0	4	4	5
Total Volume	0	0	0	15	0	15	0	17	17	32
% App. Total	0	0	0	100	0	100	0	100	100	100
PHF	.000	.000	.000	.536	.000	.536	.000	.850	.850	.667

Accurate Counts

978-664-2565

N/S Street : 3 Dover Road
 E/W Street : Dover Road
 City/State : Durham, NH
 Weather : Clear

File Name : 10078004
 Site Code : 10078004
 Start Date : 10/31/2024
 Page No : 10

Groups Printed- Bikes Peds

Start Time	3 Dover Rd From North			Dover Rd From East			Dover Rd From West			Exclu. Total	Inclu. Total	Int. Total
	Left	Right	Peds	Thru	Right	Peds	Left	Thru	Peds			
07:00 AM	0	0	0	0	0	0	0	0	0	0	0	0
07:15 AM	0	0	0	0	0	0	0	0	0	0	0	0
07:30 AM	0	0	0	0	0	0	0	0	0	0	0	0
07:45 AM	0	0	0	0	0	0	0	0	0	0	0	0
Total	0	0	0	0	0	0	0	0	0	0	0	0
08:00 AM	0	0	0	0	0	0	0	0	0	0	0	0
08:15 AM	0	0	2	2	0	0	0	0	0	2	2	4
08:30 AM	0	0	2	1	0	0	0	0	0	2	1	3
08:45 AM	0	0	0	0	0	0	0	0	0	0	0	0
Total	0	0	4	3	0	0	0	0	0	4	3	7
Grand Total	0	0	4	3	0	0	0	0	0	4	3	7
Apprch %	0	0		100	0		0	0				
Total %	0	0		100	0		0	0		57.1	42.9	

Start Time	3 Dover Rd From North			Dover Rd From East			Dover Rd From West			Int. Total
	Left	Right	App. Total	Thru	Right	App. Total	Left	Thru	App. Total	
Peak Hour Analysis From 07:00 AM to 08:45 AM - Peak 1 of 1										
Peak Hour for Entire Intersection Begins at 07:45 AM										
07:45 AM	0	0	0	0	0	0	0	0	0	0
08:00 AM	0	0	0	0	0	0	0	0	0	0
08:15 AM	0	0	0	2	0	2	0	0	0	2
08:30 AM	0	0	0	1	0	1	0	0	0	1
Total Volume	0	0	0	3	0	3	0	0	0	3
% App. Total	0	0		100	0		0	0		
PHF	.000	.000	.000	.375	.000	.375	.000	.000	.000	.375

Accurate Counts

978-664-2565

N/S Street : 3 Dover Road
 E/W Street : Dover Road
 City/State : Durham, NH
 Weather : Clear

File Name : 10078004
 Site Code : 10078004
 Start Date : 10/31/2024
 Page No : 1

Groups Printed- Cars - Trucks

Start Time	3 Dover Rd From North		Dover Rd From East		Dover Rd From West		Int. Total
	Left	Right	Thru	Right	Left	Thru	
03:00 PM	0	0	165	0	0	182	347
03:15 PM	0	0	191	0	0	180	371
03:30 PM	0	0	177	0	0	210	387
03:45 PM	0	0	160	1	0	193	354
Total	0	0	693	1	0	765	1459
04:00 PM	0	0	150	0	0	181	331
04:15 PM	0	2	145	0	2	117	266
04:30 PM	0	0	133	0	0	114	247
04:45 PM	0	0	149	0	0	144	293
Total	0	2	577	0	2	556	1137
05:00 PM	0	0	194	0	0	222	416
05:15 PM	0	0	173	0	0	204	377
05:30 PM	0	0	193	0	0	169	362
05:45 PM	0	0	168	0	0	159	327
Total	0	0	728	0	0	754	1482
Grand Total	0	2	1998	1	2	2075	4078
Apprch %	0	100	99.9	0.1	0.1	99.9	
Total %	0	0	49	0	0	50.9	
Cars	0	2	1977	1	2	2057	4039
% Cars	0	100	98.9	100	100	99.1	99
Trucks	0	0	21	0	0	18	39
% Trucks	0	0	1.1	0	0	0.9	1

Start Time	3 Dover Rd From North			Dover Rd From East			Dover Rd From West			Int. Total
	Left	Right	App. Total	Thru	Right	App. Total	Left	Thru	App. Total	
Peak Hour Analysis From 03:00 PM to 05:45 PM - Peak 1 of 1										
Peak Hour for Entire Intersection Begins at 05:00 PM										
05:00 PM	0	0	0	194	0	194	0	222	222	416
05:15 PM	0	0	0	173	0	173	0	204	204	377
05:30 PM	0	0	0	193	0	193	0	169	169	362
05:45 PM	0	0	0	168	0	168	0	159	159	327
Total Volume	0	0	0	728	0	728	0	754	754	1482
% App. Total	0	0	0	100	0	100	0	100		
PHF	.000	.000	.000	.938	.000	.938	.000	.849	.849	.891
Cars	0	0	0	724	0	724	0	752	752	1476
% Cars	0	0	0	99.5	0	99.5	0	99.7	99.7	99.6
Trucks	0	0	0	4	0	4	0	2	2	6
% Trucks	0	0	0	0.5	0	0.5	0	0.3	0.3	0.4

Accurate Counts

978-664-2565

N/S Street : 3 Dover Road
 E/W Street : Dover Road
 City/State : Durham, NH
 Weather : Clear

File Name : 10078004
 Site Code : 10078004
 Start Date : 10/31/2024
 Page No : 2

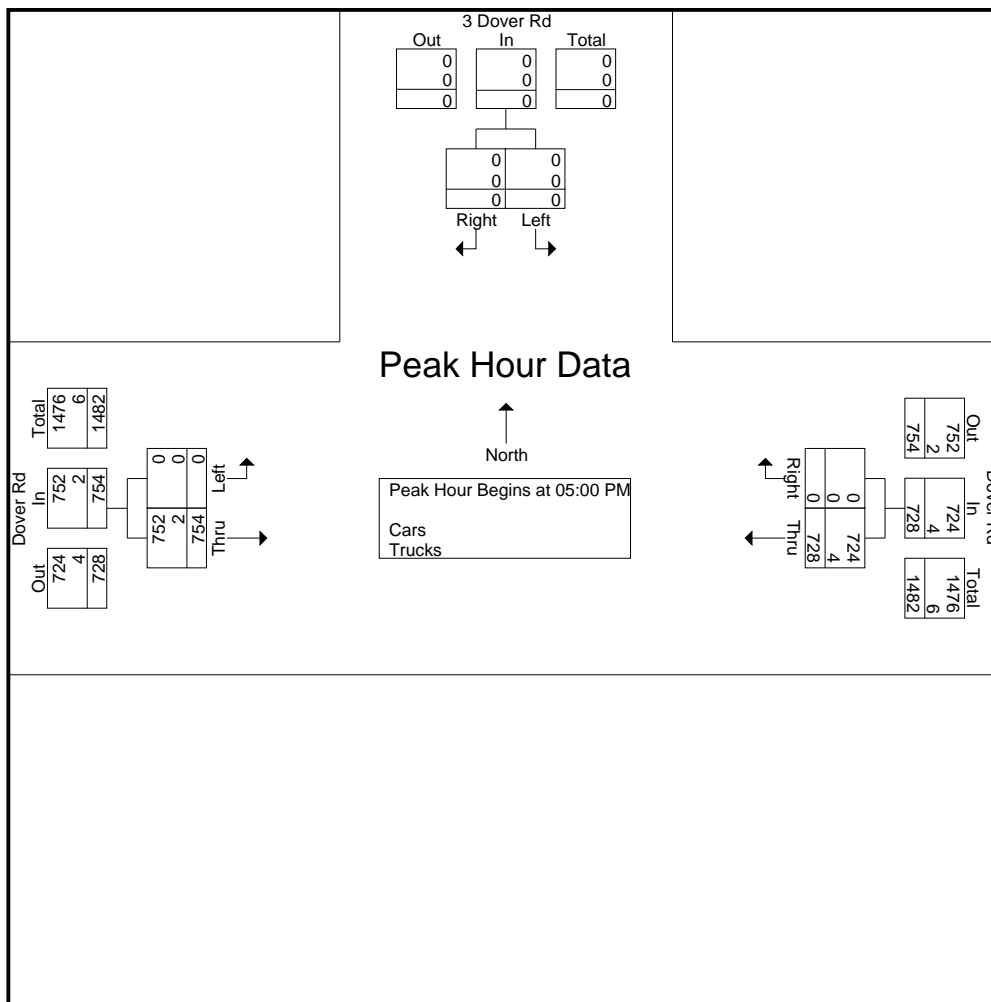

Peak Hour Analysis From 03:00 PM to 05:45 PM - Peak 1 of 1

Peak Hour for Each Approach Begins at:

	03:30 PM			05:00 PM			03:00 PM		
+0 mins.	0	0	0	194	0	194	0	182	182
+15 mins.	0	0	0	173	0	173	0	180	180
+30 mins.	0	0	0	193	0	193	0	210	210
+45 mins.	0	2	2	168	0	168	0	193	193
Total Volume	0	2	2	728	0	728	0	765	765
% App. Total	0	100		100	0	100	0	100	
PHF	.000	.250	.250	.938	.000	.938	.000	.911	.911
Cars	0	2	2	724	0	724	0	752	752
% Cars	0	100	100	99.5	0	99.5	0	98.3	98.3
Trucks	0	0	0	4	0	4	0	13	13
% Trucks	0	0	0	0.5	0	0.5	0	1.7	1.7

Accurate Counts

978-664-2565

N/S Street : 3 Dover Road
 E/W Street : Dover Road
 City/State : Durham, NH
 Weather : Clear

File Name : 10078004
 Site Code : 10078004
 Start Date : 10/31/2024
 Page No : 7

Groups Printed- Trucks

Start Time	3 Dover Rd From North		Dover Rd From East		Dover Rd From West		Int. Total
	Left	Right	Thru	Right	Left	Thru	
03:00 PM	0	0	4	0	0	6	10
03:15 PM	0	0	3	0	0	2	5
03:30 PM	0	0	4	0	0	1	5
03:45 PM	0	0	2	0	0	4	6
Total	0	0	13	0	0	13	26
04:00 PM	0	0	0	0	0	0	0
04:15 PM	0	0	1	0	0	2	3
04:30 PM	0	0	1	0	0	0	1
04:45 PM	0	0	2	0	0	1	3
Total	0	0	4	0	0	3	7
05:00 PM	0	0	0	0	0	0	0
05:15 PM	0	0	0	0	0	2	2
05:30 PM	0	0	1	0	0	0	1
05:45 PM	0	0	3	0	0	0	3
Total	0	0	4	0	0	2	6
Grand Total	0	0	21	0	0	18	39
Apprch %	0	0	100	0	0	100	
Total %	0	0	53.8	0	0	46.2	

Start Time	3 Dover Rd From North			Dover Rd From East			Dover Rd From West			Int. Total
	Left	Right	App. Total	Thru	Right	App. Total	Left	Thru	App. Total	
Peak Hour Analysis From 03:00 PM to 05:45 PM - Peak 1 of 1										
Peak Hour for Entire Intersection Begins at 03:00 PM										
03:00 PM	0	0	0	4	0	4	0	6	6	10
03:15 PM	0	0	0	3	0	3	0	2	2	5
03:30 PM	0	0	0	4	0	4	0	1	1	5
03:45 PM	0	0	0	2	0	2	0	4	4	6
Total Volume	0	0	0	13	0	13	0	13	13	26
% App. Total	0	0		100	0		0	100		
PHF	.000	.000	.000	.813	.000	.813	.000	.542	.542	.650

Accurate Counts

978-664-2565

N/S Street : 3 Dover Road
 E/W Street : Dover Road
 City/State : Durham, NH
 Weather : Clear

File Name : 10078004
 Site Code : 10078004
 Start Date : 10/31/2024
 Page No : 10

Groups Printed- Bikes Peds

Start Time	3 Dover Rd From North			Dover Rd From East			Dover Rd From West			Exclu. Total	Inclu. Total	Int. Total
	Left	Right	Peds	Thru	Right	Peds	Left	Thru	Peds			
03:00 PM	0	0	0	1	0	0	0	0	2	2	1	3
03:15 PM	0	0	0	0	0	0	0	0	0	0	0	0
03:30 PM	0	0	4	0	0	0	0	0	0	4	0	4
03:45 PM	0	0	2	1	0	0	0	0	0	2	1	3
Total	0	0	6	2	0	0	0	0	2	8	2	10
04:00 PM	0	0	0	0	0	0	0	1	0	0	1	1
04:15 PM	0	0	2	0	0	0	0	0	0	2	0	2
04:30 PM	0	0	3	2	0	0	0	0	0	3	2	5
04:45 PM	0	0	1	0	0	0	0	0	0	1	0	1
Total	0	0	6	2	0	0	0	1	0	6	3	9
05:00 PM	0	0	1	0	0	0	0	0	0	1	0	1
05:15 PM	0	0	2	0	0	0	0	0	0	2	0	2
05:30 PM	0	0	0	0	0	0	0	0	0	0	0	0
05:45 PM	0	0	4	0	0	0	0	0	0	4	0	4
Total	0	0	7	0	0	0	0	0	0	7	0	7
Grand Total	0	0	19	4	0	0	0	1	2	21	5	26
Apprch %	0	0		100	0		0	100				
Total %	0	0		80	0		0	20		80.8	19.2	

Start Time	3 Dover Rd From North			Dover Rd From East			Dover Rd From West			Int. Total
	Left	Right	App. Total	Thru	Right	App. Total	Left	Thru	App. Total	
Peak Hour Analysis From 03:00 PM to 05:45 PM - Peak 1 of 1										
Peak Hour for Entire Intersection Begins at 03:45 PM										
03:45 PM	0	0	0	1	0	1	0	0	0	1
04:00 PM	0	0	0	0	0	0	0	1	1	1
04:15 PM	0	0	0	0	0	0	0	0	0	0
04:30 PM	0	0	0	2	0	2	0	0	0	2
Total Volume	0	0	0	3	0	3	0	1	1	4
% App. Total	0	0		100	0		0	100		
PHF	.000	.000	.000	.375	.000	.375	.000	.250	.250	.500

Accurate Counts

978-664-2565

N/S Street : 3 Dover Road
 E/W Street : Dover Road
 City/State : Durham, NH
 Weather : Cloudy

File Name : 100780S4
 Site Code : 10078004
 Start Date : 11/2/2024
 Page No : 1

Groups Printed- Cars - Trucks

Start Time	3 Dover Rd From North		Dover Rd From East		Dover Rd From West		Int. Total
	Left	Right	Thru	Right	Left	Thru	
11:00 AM	0	0	121	0	0	167	288
11:15 AM	0	0	138	0	0	161	299
11:30 AM	0	0	150	0	0	188	338
11:45 AM	0	0	144	0	0	172	316
Total	0	0	553	0	0	688	1241
12:00 PM	1	0	155	1	0	181	338
12:15 PM	0	0	143	0	0	181	324
12:30 PM	0	0	139	0	0	196	335
12:45 PM	0	0	144	0	0	162	306
Total	1	0	581	1	0	720	1303
01:00 PM	0	0	182	0	0	166	348
01:15 PM	0	0	152	0	0	159	311
01:30 PM	0	0	177	0	0	198	375
01:45 PM	0	0	181	0	0	176	357
Total	0	0	692	0	0	699	1391
Grand Total	1	0	1826	1	0	2107	3935
Apprch %	100	0	99.9	0.1	0	100	
Total %	0	0	46.4	0	0	53.5	
Cars	1	0	1816	1	0	2098	3916
% Cars	100	0	99.5	100	0	99.6	99.5
Trucks	0	0	10	0	0	9	19
% Trucks	0	0	0.5	0	0	0.4	0.5

Start Time	3 Dover Rd From North			Dover Rd From East			Dover Rd From West			Int. Total
	Left	Right	App. Total	Thru	Right	App. Total	Left	Thru	App. Total	
Peak Hour Analysis From 11:00 AM to 01:45 PM - Peak 1 of 1										
Peak Hour for Entire Intersection Begins at 01:00 PM										
01:00 PM	0	0	0	182	0	182	0	166	166	348
01:15 PM	0	0	0	152	0	152	0	159	159	311
01:30 PM	0	0	0	177	0	177	0	198	198	375
01:45 PM	0	0	0	181	0	181	0	176	176	357
Total Volume	0	0	0	692	0	692	0	699	699	1391
% App. Total	0	0	0	100	0	100	0	100		
PHF	.000	.000	.000	.951	.000	.951	.000	.883	.883	.927
Cars	0	0	0	689	0	689	0	695	695	1384
% Cars	0	0	0	99.6	0	99.6	0	99.4	99.4	99.5
Trucks	0	0	0	3	0	3	0	4	4	7
% Trucks	0	0	0	0.4	0	0.4	0	0.6	0.6	0.5

Accurate Counts

978-664-2565

File Name : 100780S4

Site Code : 10078004

Start Date : 11/2/2024

Page No : 2

N/S Street : 3 Dover Road

E/W Street : Dover Road

City/State : Durham, NH

Weather : Cloudy

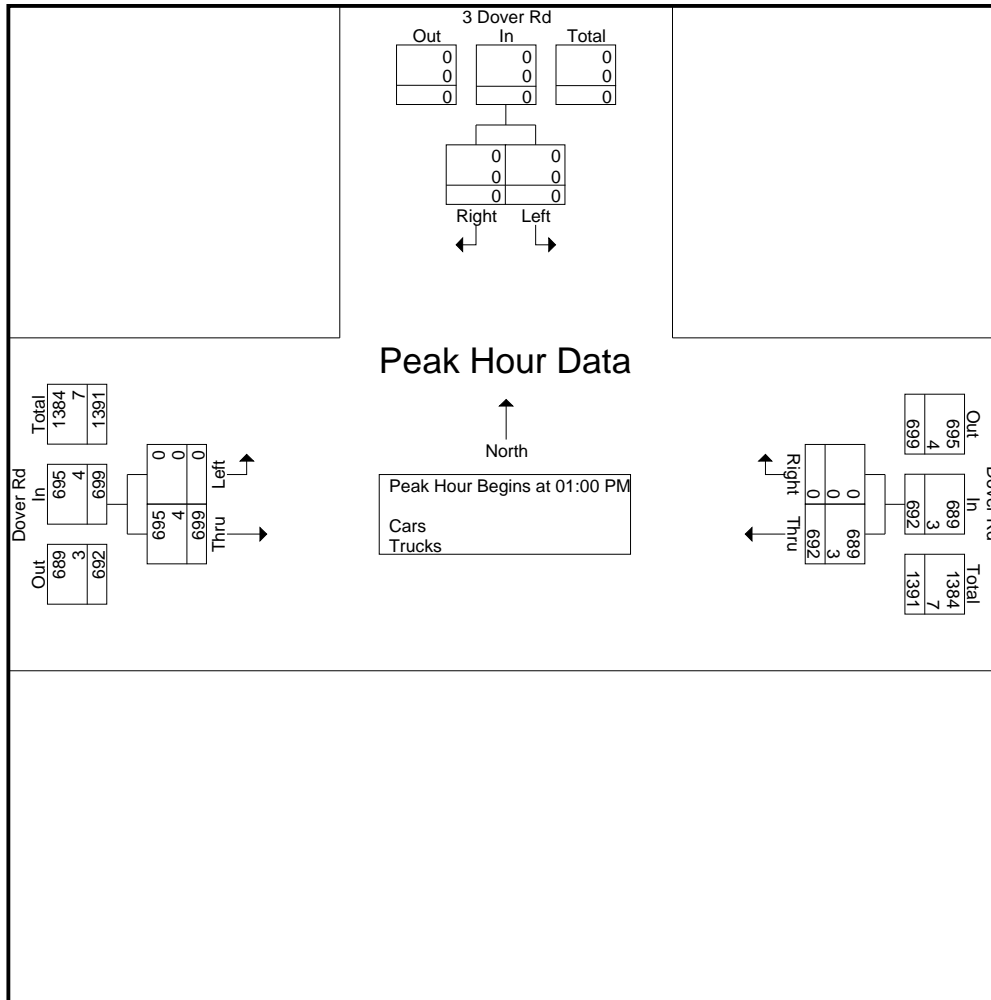

Peak Hour Analysis From 11:00 AM to 01:45 PM - Peak 1 of 1

Peak Hour for Each Approach Begins at:

	11:15 AM			01:00 PM			11:45 AM		
+0 mins.	0	0	0	182	0	182	0	172	172
+15 mins.	0	0	0	152	0	152	0	181	181
+30 mins.	0	0	0	177	0	177	0	181	181
+45 mins.	1	0	1	181	0	181	0	196	196
Total Volume	1	0	1	692	0	692	0	730	730
% App. Total	100	0		100	0		0	100	
PHF	.250	.000	.250	.951	.000	.951	.000	.931	.931
Cars	1	0	1	689	0	689	0	726	726
% Cars	100	0	100	99.6	0	99.6	0	99.5	99.5
Trucks	0	0	0	3	0	3	0	4	4
% Trucks	0	0	0	0.4	0	0.4	0	0.5	0.5

Accurate Counts

978-664-2565

N/S Street : 3 Dover Road
 E/W Street : Dover Road
 City/State : Durham, NH
 Weather : Cloudy

File Name : 100780S4
 Site Code : 10078004
 Start Date : 11/2/2024
 Page No : 7

Groups Printed- Trucks

Start Time	3 Dover Rd From North		Dover Rd From East		Dover Rd From West		Int. Total
	Left	Right	Thru	Right	Left	Thru	
11:00 AM	0	0	2	0	0	0	2
11:15 AM	0	0	0	0	0	0	0
11:30 AM	0	0	1	0	0	0	1
11:45 AM	0	0	1	0	0	2	3
Total	0	0	4	0	0	2	6
12:00 PM	0	0	1	0	0	0	1
12:15 PM	0	0	0	0	0	1	1
12:30 PM	0	0	1	0	0	1	2
12:45 PM	0	0	1	0	0	1	2
Total	0	0	3	0	0	3	6
01:00 PM	0	0	2	0	0	1	3
01:15 PM	0	0	0	0	0	2	2
01:30 PM	0	0	1	0	0	0	1
01:45 PM	0	0	0	0	0	1	1
Total	0	0	3	0	0	4	7
Grand Total	0	0	10	0	0	9	19
Apprch %	0	0	100	0	0	100	
Total %	0	0	52.6	0	0	47.4	

Start Time	3 Dover Rd From North			Dover Rd From East			Dover Rd From West			Int. Total
	Left	Right	App. Total	Thru	Right	App. Total	Left	Thru	App. Total	
Peak Hour Analysis From 11:00 AM to 01:45 PM - Peak 1 of 1										
Peak Hour for Entire Intersection Begins at 12:30 PM										
12:30 PM	0	0	0	1	0	1	0	1	1	2
12:45 PM	0	0	0	1	0	1	0	1	1	2
01:00 PM	0	0	0	2	0	2	0	1	1	3
01:15 PM	0	0	0	0	0	0	0	2	2	2
Total Volume	0	0	0	4	0	4	0	5	5	9
% App. Total	0	0	0	100	0	100	0	100	100	100
PHF	.000	.000	.000	.500	.000	.500	.000	.625	.625	.750

Accurate Counts

978-664-2565

N/S Street : 3 Dover Road
 E/W Street : Dover Road
 City/State : Durham, NH
 Weather : Cloudy

File Name : 100780S4
 Site Code : 10078004
 Start Date : 11/2/2024
 Page No : 10

Groups Printed- Bikes Peds

Start Time	3 Dover Rd From North			Dover Rd From East			Dover Rd From West			Exclu. Total	Inclu. Total	Int. Total
	Left	Right	Peds	Thru	Right	Peds	Left	Thru	Peds			
11:00 AM	0	0	0	1	0	0	0	1	0	0	2	2
11:15 AM	0	0	0	0	0	0	0	0	0	0	0	0
11:30 AM	0	0	1	0	0	0	0	0	0	1	0	1
11:45 AM	0	0	0	0	0	0	0	1	0	0	1	1
Total	0	0	1	1	0	0	0	2	0	1	3	4
12:00 PM	0	0	0	0	0	0	0	0	0	0	0	0
12:15 PM	0	0	2	0	0	0	0	0	0	2	0	2
12:30 PM	0	0	1	0	0	0	0	0	0	1	0	1
12:45 PM	0	0	1	0	0	0	0	0	0	1	0	1
Total	0	0	4	0	0	0	0	0	0	4	0	4
01:00 PM	0	0	0	0	0	0	0	0	0	0	0	0
01:15 PM	0	0	0	0	0	0	0	2	0	0	2	2
01:30 PM	0	0	2	0	0	0	0	0	0	2	0	2
01:45 PM	0	0	1	1	0	0	0	0	0	1	1	2
Total	0	0	3	1	0	0	0	2	0	3	3	6
Grand Total	0	0	8	2	0	0	0	4	0	8	6	14
Apprch %	0	0		100	0		0	100				
Total %	0	0		33.3	0		0	66.7		57.1	42.9	

Start Time	3 Dover Rd From North			Dover Rd From East			Dover Rd From West			Int. Total
	Left	Right	App. Total	Thru	Right	App. Total	Left	Thru	App. Total	
Peak Hour Analysis From 11:00 AM to 01:45 PM - Peak 1 of 1										
Peak Hour for Entire Intersection Begins at 11:00 AM										
11:00 AM	0	0	0	1	0	1	0	1	1	2
11:15 AM	0	0	0	0	0	0	0	0	0	0
11:30 AM	0	0	0	0	0	0	0	0	0	0
11:45 AM	0	0	0	0	0	0	0	1	1	1
Total Volume	0	0	0	1	0	1	0	2	2	3
% App. Total	0	0	0	100	0	100	0	100	0	0
PHF	.000	.000	.000	.250	.000	.250	.000	.500	.500	.375

Thursday December 12th 2024

Start Time	Pedestrian		Vehicle		Total		In	Out
	In	Out	In	Out	In	Out		
7:00 AM	1	0	14	13	15	13		
7:15 AM	0	1	16	24	16	25		
7:30 AM	0	0	16	19	16	19		
7:45 AM	0	0	18	15	18	15	137	
8:00 AM	1	1	10	13	11	14	134	61
8:15 AM	0	0	8	10	8	10	111	
8:30 AM	1	1	15	17	16	18	110	
8:45 AM	1	1	11	12	12	13	102	
Total	4	4	108	123	112	127		

Start Time	Pedestrian		Vehicle		Total		In	Out
	In	Out	In	Out	In	Out		
3:00 PM	0	0	2	2	2	2		
3:15 PM	0	0	9	3	9	3		
3:30 PM	0	0	4	11	4	11		
3:45 PM	0	0	8	8	8	8	47	
4:00 PM	0	0	5	7	5	7	55	26
4:15 PM	0	0	2	2	2	2	47	
4:30 PM	2	2	5	1	7	3	42	
4:45 PM	0	0	1	3	1	3	30	
5:00 PM	0	0	5	5	5	5	28	
5:15 PM	0	0	3	3	3	3	30	
5:30 PM	0	0	1	1	1	1	22	
5:45 PM	0	0	2	1	2	1	21	
Total	2	2	47	47	49	49		

COVID ADJUSTMENT DATA



		Weekday Daily	AM Peak	PM Peak
October	2019	17,399	1,047	1,568
	2024	18,920	1,242	1,644
	Change	0.92	0.84	0.95

		Weekday Daily	AM Peak	PM Peak
October	2019	17,399	1,047	1,568
	2024	18,605	1,252	1,628
	Change	0.94	0.84	0.96

		Saturday Daily	SAT Peak
December	2019	15,876	1,262
	2024	16,153	1,301
	Change	0.98	0.97

SEASONAL ADJUSTMENT DATA



Year 2019 Monthly Data

Town: Durham
Station: 02133021
Location: US 4 east of NH 108
Group: 4

<u>Month</u>	<u>ADT</u>	<u>Adjustment to Average</u>	<u>Adjustment to Peak</u>
January	13,359	1.17	1.27
February	15,206	1.03	1.11
March	14,953	1.04	1.13
April	16,518	0.94	1.03
May	16,337	0.95	1.04
June	15,630	1.00	1.08
July	15,749	0.99	1.08
August	16,939	0.92	1.00
September	16,858	0.93	1.00
October	16,859	0.93	1.00
November	15,607	1.00	1.09
December	13,647	1.14	1.24

AADT: 15,596
Peak Month: 16,939

PUBLIC TRANSPORTATION SCHEDULES





Transportation

[Buses and Shuttles](#) › Fares & Information

IN THIS SECTION

Fares & Information

Service Date Holidays and Exceptions

[WILDCAT TRANSIT](#) ›

[CAMPUS CONNECTOR](#) ›

Dispatch Center Office and Call Center Hours

Full-service periods

Monday through Friday, 6:30 a.m. to 10:30 p.m.

Saturday through Sunday, 10 a.m. to 10 p.m.

Reduced Service periods (see above for dates)

Monday through Friday, 7 a.m. to 6 p.m.

Office closed? Please remember that [Bus Predictions](#) are available to you 24/7.

Bus Fares

- Transit routes \$1.50/ride. Exact fare required; drivers do not make change.
- The fare for UNH and UNHM students is covered by the Transportation Fee, but students must show their valid UNH ID when boarding (\$1.50 cash fare without ID card).
- UNH Faculty and staff may board for free by showing their current UNH ID (\$1.50 cash fare without ID card).
- Children under 5 ride free.
- COAST monthly passes and single ride tickets are accepted on Wildcat Transit buses.
- Half-fare policy: Passengers over 65 or passengers with disabilities displaying a valid Medicare card may board for half fare (Medicaid not eligible). [Half-fare application form](#)
- All Campus Connector routes are free, no ID necessary.

MULTI-RIDE BUS PASSES:

Wildcat Transit 3-month, 1-month, and 10-ride passes available.

[BUS PASS ONLINE ORDERING SITE.](#) ›

General Rider Information

- **Schedule times** are approximate; actual arrival/departure times may vary. Arrive five minutes before the scheduled time. Connections and arrival times are not guaranteed; service and fees subject to change .
- **Passenger pick-up and drop-off** are permitted at designated bus stops only. To request a stop that isn't routine, pull the “stop requested” cord or ask your driver.

- **Wheelchair access:** All transit buses are equipped with wheelchair lifts. It is recommended but not required that you call if you will be requiring the lift.
- **Bicycles** are permitted on the external racks only and cannot be brought on board a bus. Racks are available on a first-come, first-served basis. Wildcat Transit assumes no responsibility for bikes except in the event of a collision.
- **Strollers/baby carriages** must be folded up and secured under the seats.
- **Children** under 12 must be accompanied by an adult.
- **Large items** such as skis are not permitted on the bus. Personal (miniature) grocery carts are allowed but must be held securely at all times.
- **Animals:** For the comfort and safety of our passengers, animals are not permitted on the bus with the exception of trained service animals accompanying a legally disabled person. Emotional support animals are not considered to be trained service animals and are therefore not permitted on the bus.
- **Passenger conduct:** Passengers are expected to conduct themselves civilly for the safety and comfort of all on board. No eating, drinking, or use of tobacco products. Appropriate clothing, including shirts and shoes, is required. Please keep feet off the seats and help keep the passenger area clean. [Please read the full Passenger Code of Conduct.](#)

TRANSPORTATION SERVICES

Parking

Buses & Shuttles

Arrival Predictions

Pay/Appeal Tickets

Defensive Driving

Employment

Newsletter Subscriptions

Transportation Policy Committee

MORE TO EXPLORE

ID Office

Conferences & Catering

Dining

Housing & Residential Life

Printing & Mailing Services

UNH Health Services

Memorial Union Building

Campus Recreation

Copyright © 2024, University of New Hampshire. All rights reserved.

TTY Users: 7-1-1 or 800-735-2964 (Relay NH)

CONTACT US

Transportation

Transit & Connector: (603) 862-2328

Transit Bldg

20 Sage Way

Parking: (603) 862-1010

Campus Services Office

83 Main Street - MUB Room 211

Fax: (603) 862-2638

Wildcat Transit - Dover Route 3



Wildcat Transit Route 3



COAST Route to Rochester & Portsmouth



COAST Route to Somersworth & Dover

0 0.25 0.5 Miles

- ▼ Bus Stop
- ⊗ Transit Transfer Point
- ⊙ Intermodal Transfer Station
- 🎓 School
- 🏠 Housing Auth.
- 🛒 Shopping
- 📖 Library
- 🏠 Apartments
- 🚌 Bus Terminal
- 🏥 Hospital

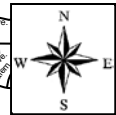
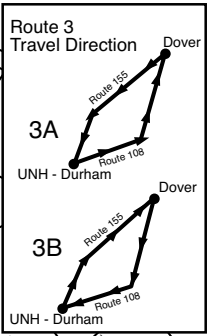
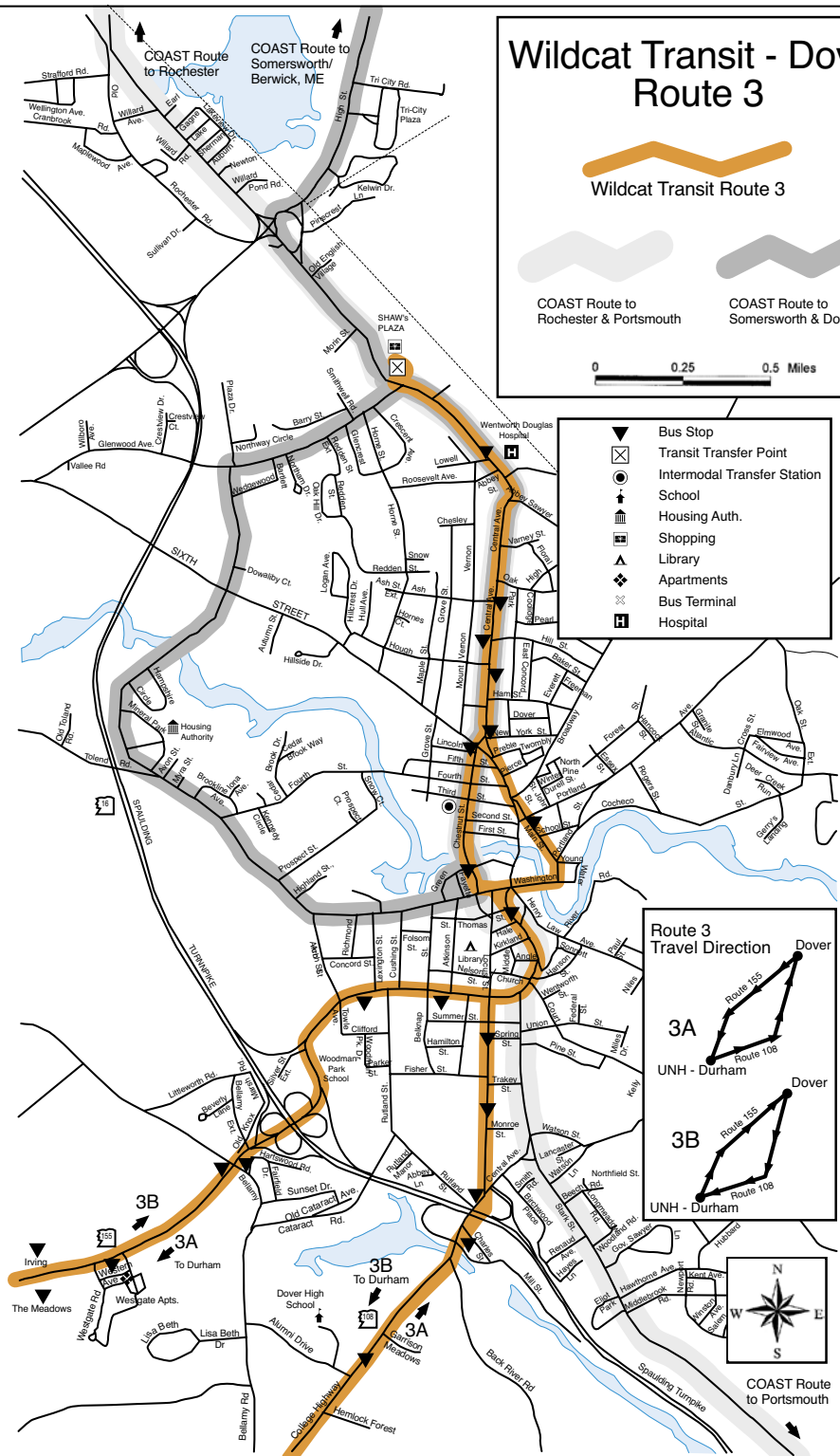

COAST Route to Portsmouth

Route 3A Saturday

Dover 3A

UNH/Durham to Dover via Route 108 /

Dover to UNH/Durham via Route 155

Saturday Only

Stop ID # & Location				
Outbound	Run 1	Run 2	Run 3	
101	DEPART UNH McCONNELL HALL	10:05 AM	2:05 PM	6:35 PM
102	DEPART UNH KINGSBURY HALL	10:07 AM	2:07 PM	6:37 PM
103	DEPART UNH HEWITT HALL	10:07 AM	2:07 PM	6:37 PM
104	DEPART MAIN STREET @ UNH THOMPSON HALL	10:10 AM	2:10 PM	6:40 PM
106	DEPART MAIN STREET @ UNH HETZEL HALL	10:12 AM	2:12 PM	6:42 PM
107	Rte 108 @ Old Landing Rd	10:14 AM	2:14 PM	6:44 PM
109	Rte 108 @ Old Piscataqua Rd	10:14 AM	2:14 PM	6:44 PM
144	Rte 108 @ Stone Quarry Drive	10:14 AM	2:14 PM	6:44 PM
808	Rte 108 @ Little Tree Education	10:18 AM	2:18 PM	6:48 PM
241	Rte 108 @ Arrow Brook Rd	10:19 AM	2:19 PM	6:49 PM
243	Rte 108 @ Mast Rd	10:19 AM	2:19 PM	6:49 PM
223	Rte 108 @ Adelle Drive	10:20 AM	2:20 PM	6:50 PM
224	Rte 108 @ Dover Veterinary Hospital	10:21 AM	2:21 PM	6:51 PM
225	Rte 108 @ Charles St [Sullivan Tire]	10:23 AM	2:23 PM	6:53 PM
226	218 Locust Street	10:24 AM	2:24 PM	6:54 PM
221	180 Locust Street	10:24 AM	2:24 PM	6:54 PM
250	Central Ave @ Central Towers	10:26 AM	2:26 PM	6:56 PM
239	Main Street @ Janetos	10:28 AM	2:28 PM	6:58 PM
209	Central Ave @ New York Street	10:29 AM	2:29 PM	6:59 PM
207	Central Ave @ Tasker Funeral Home	10:30 AM	2:30 PM	7:00 PM
210	Central Ave @ Oak Street	10:31 AM	2:31 PM	7:01 PM
204	Central Ave @ Wentworth Douglass Hospital	10:33 AM	2:33 PM	7:03 PM
203	Arrive Shaws	10:36 AM	2:36 PM	7:06 PM
Inbound				
203	Depart Shaws	10:36 AM	2:36 PM	7:06 PM
205	Central Ave @ Abbott Street	10:38 AM	2:38 PM	7:08 PM
206	Central Ave @ Ash Street	10:39 AM	2:39 PM	7:09 PM
208	Central Ave @ Hough St [U-Haul]	10:39 AM	2:39 PM	7:09 PM
213	Chestnut Street @ Carswell Auto	10:41 AM	2:41 PM	7:11 PM
214	Dover Transportation Center	10:42 AM	2:42 PM	7:12 PM
212	Chestnut Street @ Riverview Apartments	10:44 AM	2:44 PM	7:14 PM
202	Central Ave @ Dover City Hall	10:46 AM	2:46 PM	7:16 PM
233	Silver Street @ Atkinson Street	10:48 AM	2:48 PM	7:18 PM
234	Silver Street @ Lexington Street	10:48 AM	2:48 PM	7:18 PM
220	Rte 155 @ Littleworth Rd	10:50 AM	2:50 PM	7:20 PM
240	Rte 155 @ White Cliff Apartments	10:51 AM	2:51 PM	7:21 PM
235	Rte 155 @ Irving Gas Station	10:52 AM	2:52 PM	7:22 PM
215	Rte 155 @ Knox Marsh Apartments	10:53 AM	2:53 PM	7:23 PM
807	Rte 155 @ Land Care Associates	10:53 AM	2:53 PM	7:23 PM
805	Rte 155 @ Pudding Hill Rd	10:53 AM	2:53 PM	7:23 PM
801	191 Madbury Road	10:55 AM	2:55 PM	7:25 PM
111	Madbury Road @ Rte 4	10:56 AM	2:56 PM	7:26 PM
147	Madbury Road @ Lundy Lane	10:57 AM	2:57 PM	7:27 PM
113	Madbury Road @ Edgewood Rd	10:58 AM	2:58 PM	7:28 PM
114	Madbury Road @ Durham Public Library	11:00 AM	3:00 PM	7:30 PM
116	ARRIVE Garrison Ave @ Sawyer Hall	11:01 AM	3:01 PM	7:31 PM
105	ARRIVE Holloway Commons Main Street	11:02 AM	3:02 PM	7:32 PM
1001	ARRIVE UNH McConnell Hall	11:04 AM	3:04 PM	7:34 PM

These times are approximate. Please be at the bus stop 5 minutes before the scheduled time.

There is no service on Sundays

There is no weekend service during periods of "Reduced Service"

Route 3A Weekday

Dover 3A

UNH/Durham to Dover via Route 108 /

Reduced Service

Dover to UNH/Durham via Route 155

Monday - Friday

Stop ID # & Location				
Outbound		Run 1	Run 2	Run 3
101	DEPART UNH McCONNELL HALL	10:05 AM	12:05 PM	6:05 PM
102	DEPART UNH KINGSBURY HALL	10:07 AM	12:07 PM	6:07 PM
103	DEPART UNH HEWITT HALL	10:07 AM	12:07 PM	6:07 PM
104	DEPART MAIN STREET @ UNH THOMPSON HALL	10:10 AM	12:10 PM	6:10 PM
106	DEPART MAIN STREET @ UNH HETZEL HALL	10:12 AM	12:12 PM	6:12 PM
107	Rte 108 @ Old Landing Rd	10:14 AM	12:14 PM	6:14 PM
109	Rte 108 @ Old Piscataqua Rd	10:14 AM	12:14 PM	6:14 PM
144	Rte 108 @ Stone Quarry Drive	10:14 AM	12:14 PM	6:14 PM
808	Rte 108 @ Little Tree Education	10:18 AM	12:18 PM	6:18 PM
241	Rte 108 @ Arrow Brook Rd	10:19 AM	12:19 PM	6:19 PM
243	Rte 108 @ Mast Rd	10:19 AM	12:19 PM	6:19 PM
223	Rte 108 @ Adelle Drive	10:20 AM	12:20 PM	6:20 PM
224	Rte 108 @ Dover Veterinary Hospital	10:21 AM	12:21 PM	6:21 PM
225	Rte 108 @ Charles St [Sullivan Tire]	10:23 AM	12:23 PM	6:23 PM
226	218 Locust Street	10:24 AM	12:24 PM	6:24 PM
221	180 Locust Street	10:24 AM	12:24 PM	6:24 PM
250	Central Ave @ Central Towers	10:26 AM	12:26 PM	6:26 PM
239	Main Street @ Janetos	10:28 AM	12:28 PM	6:28 PM
209	Central Ave @ New York Street	10:29 AM	12:29 PM	6:29 PM
207	Central Ave @ Tasker Funeral Home	10:30 AM	12:30 PM	6:30 PM
210	Central Ave @ Oak Street	10:31 AM	12:31 PM	6:31 PM
204	Central Ave @ Wentworth Douglass Hospital	10:33 AM	12:33 PM	6:33 PM
203	Arrive Shaws	10:36 AM	12:36 PM	6:36 PM
Inbound				
203	Depart Shaws	10:36 AM	12:36 PM	6:36 PM
205	Central Ave @ Abbott Street	10:38 AM	12:38 PM	6:38 PM
206	Central Ave @ Ash Street	10:39 AM	12:39 PM	6:39 PM
208	Central Ave @ Hough St [U-Haul]	10:39 AM	12:39 PM	6:39 PM
213	Chestnut Street @ Carswell Auto	10:41 AM	12:41 PM	6:41 PM
214	Dover Transportation Center	10:42 AM	12:42 PM	6:42 PM
212	Chestnut Street @ Riverview Apartments	10:44 AM	12:44 PM	6:44 PM
202	Central Ave @ Dover City Hall	10:46 AM	12:46 PM	6:46 PM
233	Silver Street @ Atkinson Street	10:48 AM	12:48 PM	6:48 PM
234	Silver Street @ Lexington Street	10:48 AM	12:48 PM	6:48 PM
220	Rte 155 @ Littleworth Rd	10:50 AM	12:50 PM	6:50 PM
240	Rte 155 @ White Cliff Apartments	10:51 AM	12:51 PM	6:51 PM
235	Rte 155 @ Irving Gas Station	10:52 AM	12:52 PM	6:52 PM
215	Rte 155 @ Knox Marsh Apartments	10:53 AM	12:53 PM	6:53 PM
807	Rte 155 @ Land Care Associates	10:53 AM	12:53 PM	6:53 PM
805	Rte 155 @ Pudding Hill Rd	10:53 AM	12:53 PM	6:53 PM
801	191 Madbury Road	10:55 AM	12:55 PM	6:55 PM
111	Madbury Road @ Rte 4	10:56 AM	12:56 PM	6:56 PM
147	Madbury Road @ Lundy Lane	10:57 AM	12:57 PM	6:57 PM
113	Madbury Road @ Edgewood Rd	10:58 AM	12:58 PM	6:58 PM
114	Madbury Road @ Durham Public Library	11:00 AM	1:00 PM	7:00 PM
116	ARRIVE Garrison Ave @ Sawyer Hall	11:01 AM	1:01 PM	7:01 PM
105	ARRIVE Holloway Commons Main Street	11:02 AM	1:02 PM	7:02 PM
1001	ARRIVE UNH McConnell Hall	11:04 AM	1:04 PM	7:04 PM

These times are approximate. Please be at the bus stop 5 minutes before the scheduled time.

Route 3A Weekday

Dover 3A

UNH/Durham to Dover via Route 108 / Dover to UNH/Durham via Route 155

Monday - Friday

Stop ID # & Location	Run 1	Run 2	Run 3	Run 4	Run 5	Run 6	Run 7
Outbound to Dover							
101 DEPART UNH McCONNELL HALL	6:40 AM	7:45 AM	8:55 AM	11:05 AM	1:05 PM	3:35 PM	5:05 PM
152 DEPART MITCHELL WAY @ McDANIEL DRIVE	6:41 AM	7:46 AM	8:56 AM	11:06 AM	1:06 PM	3:36 PM	5:06 PM
102 DEPART UNH KINGSBURY HALL	6:42 AM	7:47 AM	8:57 AM	11:07 AM	1:07 PM	3:37 PM	5:07 PM
103 DEPART UNH HEWITT HALL	6:42 AM	7:47 AM	8:57 AM	11:07 AM	1:07 PM	3:37 PM	5:07 PM
104 DEPART MAIN ST @ UNH THOMPSON HALL	6:45 AM	7:50 AM	9:00 AM	11:10 AM	1:10 PM	3:40 PM	5:10 PM
105 DEPART MAIN ST @ HOLLOWAY COMMONS	6:46 AM	7:51 AM	9:01 AM	11:11 AM	1:11 PM	3:41 PM	5:11 PM
106 DEPART MAIN STREET @ UNH HETZEL HALL	6:47 AM	7:52 AM	9:02 AM	11:12 AM	1:12 PM	3:42 PM	5:12 PM
107 Rte 108 @ Old Landing Rd	6:49 AM	7:54 AM	9:04 AM	11:14 AM	1:14 PM	3:44 PM	5:14 PM
109 Rte 108 @ Old Piscataqua Rd	6:49 AM	7:54 AM	9:04 AM	11:14 AM	1:14 PM	3:44 PM	5:14 PM
144 Rte 108 @ Stone Quarry Drive	6:49 AM	7:54 AM	9:04 AM	11:14 AM	1:14 PM	3:44 PM	5:14 PM
810 Rte 108 @ 354 NH-108	6:50 AM	7:55 AM	9:05 AM	11:15 AM	1:15 PM	3:45 PM	5:15 PM
808 Rte 108 @ Little Tree Education	6:53 AM	7:58 AM	9:08 AM	11:18 AM	1:18 PM	3:48 PM	5:18 PM
241 Rte 108 @ Arrow Brook Rd	6:54 AM	7:59 AM	9:09 AM	11:19 AM	1:19 PM	3:49 PM	5:19 PM
243 Rte 108 @ Mast Rd	6:54 AM	7:59 AM	9:09 AM	11:19 AM	1:19 PM	3:49 PM	5:19 PM
223 Rte 108 @ Adelle Drive	6:55 AM	8:00 AM	9:10 AM	11:20 AM	1:20 PM	3:50 PM	5:20 PM
224 Rte 108 @ Dover Veterinary Hospital	6:56 AM	8:01 AM	9:11 AM	11:21 AM	1:21 PM	3:51 PM	5:21 PM
225 Rte 108 @ Charles St [Sullivan Tire]	6:58 AM	8:03 AM	9:13 AM	11:23 AM	1:23 PM	3:53 PM	5:23 PM
226 218 Locust Street	6:59 AM	8:04 AM	9:14 AM	11:24 AM	1:24 PM	3:54 PM	5:24 PM
221 180 Locust Street	6:59 AM	8:04 AM	9:14 AM	11:24 AM	1:24 PM	3:54 PM	5:24 PM
250 Central Ave @ Central Towers	7:01 AM	8:06 AM	9:16 AM	11:26 AM	1:26 PM	3:56 PM	5:26 PM
239 Main Street @ Janetos	7:03 AM	8:08 AM	9:18 AM	11:28 AM	1:28 PM	3:58 PM	5:28 PM
209 Central Ave @ New York Street	7:04 AM	8:09 AM	9:19 AM	11:29 AM	1:29 PM	3:59 PM	5:29 PM
207 Central Ave @ Tasker Funeral Home	7:05 AM	8:10 AM	9:20 AM	11:30 AM	1:30 PM	4:00 PM	5:30 PM
210 Central Ave @ Oak Street	7:06 AM	8:11 AM	9:21 AM	11:31 AM	1:31 PM	4:01 PM	5:31 PM
204 Central Ave @ Wentworth Douglass Hospital	7:08 AM	8:13 AM	9:23 AM	11:33 AM	1:33 PM	4:03 PM	5:33 PM
203 Arrive Shaws	7:11 AM	8:16 AM	9:26 AM	11:36 AM	1:36 PM	4:06 PM	5:36 PM
Inbound to Durham							
203 Depart Shaws	7:11 AM	8:16 AM	9:26 AM	11:36 AM	1:36 PM	4:06 PM	5:36 PM
205 Central Ave @ Abbott Street	7:13 AM	8:18 AM	9:28 AM	11:38 AM	1:38 PM	4:08 PM	5:38 PM
206 Central Ave @ Ash Street	7:14 AM	8:19 AM	9:29 AM	11:39 AM	1:39 PM	4:09 PM	5:39 PM
208 Central Ave @ Hough St [U-Haul]	7:14 AM	8:19 AM	9:29 AM	11:39 AM	1:39 PM	4:09 PM	5:39 PM
213 Chestnut Street @ Carswell Auto	7:16 AM	8:21 AM	9:31 AM	11:41 AM	1:41 PM	4:11 PM	5:41 PM
214 Dover Transportation Center	7:17 AM	8:22 AM	9:32 AM	11:42 AM	1:42 PM	4:12 PM	5:42 PM
212 Chestnut Street @ Riverview Apartments	7:19 AM	8:24 AM	9:34 AM	11:44 AM	1:44 PM	4:14 PM	5:44 PM
202 Central Ave @ Dover City Hall	7:21 AM	8:26 AM	9:36 AM	11:46 AM	1:46 PM	4:16 PM	5:46 PM
233 Silver Street @ Atkinson Street	7:23 AM	8:28 AM	9:38 AM	11:48 AM	1:48 PM	4:18 PM	5:48 PM
234 Silver Street @ Lexington Street	7:23 AM	8:28 AM	9:38 AM	11:48 AM	1:48 PM	4:18 PM	5:48 PM
220 Rte 155 @ Littleworth Rd	7:25 AM	8:30 AM	9:40 AM	11:50 AM	1:50 PM	4:20 PM	5:50 PM
240 Rte 155 @ White Cliff Apartments	7:26 AM	8:31 AM	9:41 AM	11:51 AM	1:51 PM	4:21 PM	5:51 PM
235 Rte 155 @ Irving Gas Station	7:27 AM	8:32 AM	9:42 AM	11:52 AM	1:52 PM	4:22 PM	5:52 PM
215 Rte 155 @ Knox Marsh Apartments	7:28 AM	8:33 AM	9:43 AM	11:53 AM	1:53 PM	4:23 PM	5:53 PM
807 Rte 155 @ 299 Knox Marsh Rd	7:28 AM	8:33 AM	9:43 AM	11:53 AM	1:53 PM	4:23 PM	5:53 PM
805 Rte 155 @ Pudding Hill Rd	7:28 AM	8:33 AM	9:43 AM	11:53 AM	1:53 PM	4:23 PM	5:53 PM
801 191 Madbury Road	7:30 AM	8:35 AM	9:45 AM	11:55 AM	1:55 PM	4:25 PM	5:55 PM
111 Madbury Road @ Rte 4	7:31 AM	8:36 AM	9:46 AM	11:56 AM	1:56 PM	4:26 PM	5:56 PM
147 Madbury Road @ Lundy Lane	7:32 AM	8:37 AM	9:47 AM	11:57 AM	1:57 PM	4:27 PM	5:57 PM
113 Madbury Road @ Edgewood Rd	7:33 AM	8:38 AM	9:48 AM	11:58 AM	1:58 PM	4:28 PM	5:58 PM
114 Madbury Road @ Durham Public Library	7:35 AM	8:40 AM	9:50 AM	12:00 PM	2:00 PM	4:30 PM	6:00 PM
116 ARRIVE Garrison Ave @ Sawyer Hall	7:36 AM	8:41 AM	9:51 AM	12:01 PM	2:01 PM	4:31 PM	6:01 PM
105 ARRIVE Main Street @ Holloway Commons	7:37 AM	8:42 AM	9:52 AM	12:02 PM	2:02 PM	4:32 PM	6:02 PM
1001 ARRIVE UNH McConnell Hall	7:39 AM	8:44 AM	9:54 AM	12:04 PM	2:04 PM	4:34 PM	6:04 PM

These times are approximate. Please be at the bus stop 5 minutes before the scheduled time.

Route 3B Saturday

Dover 3B

UNH/Durham to Dover via Route 155 /

Dover to UNH/Durham via Route 108

Saturday Only

Stop ID # & Location			
Outbound	Run 1	Run 2	Run 3
101 DEPART UNH McCONNELL HALL	11:05 AM	4:05 PM	8:05 PM
102 DEPART UNH KINGSBURY HALL	11:07 AM	4:07 PM	8:07 PM
103 DEPART UNH HEWITT HALL	11:07 AM	4:07 PM	8:07 PM
104 DEPART MAIN STREET @ UNH THOMPSON HALL	11:10 AM	4:10 PM	8:10 PM
106 DEPART MAIN STREET @ UNH HETZEL HALL	11:12 AM	4:12 PM	8:12 PM
117 Madbury Road @ Woodman Rd	11:13 AM	4:13 PM	8:13 PM
115 30 Madbury Rd	11:13 AM	4:13 PM	8:13 PM
118 Madbury Road @ Bagdad Woods	11:14 AM	4:14 PM	8:14 PM
182 Madbury Road @ Davis Court Apartments	11:14 AM	4:14 PM	8:14 PM
112 90 Madbury Rd	11:14 AM	4:14 PM	8:14 PM
146 Madbury Road @ Emerson Rd	11:14 AM	4:14 PM	8:14 PM
110 Madbury Road @ Pendexter Rd	11:16 AM	4:16 PM	8:16 PM
802 Madbury Road @ Rte 155	11:19 AM	4:19 PM	8:19 PM
804 Rte 155 @ Garlands Garage	11:20 AM	4:20 PM	8:20 PM
806 Rte 155 @ 280 Knox Marsh Rd	11:21 AM	4:21 PM	8:21 PM
216 Rte 155 @ Olde Madbury Lane Apartments	11:21 AM	4:21 PM	8:21 PM
217 Rte 155 @ Lilac Garden Apartments	11:22 AM	4:22 PM	8:22 PM
218 Rte 155 @ Westgate Apartments	11:23 AM	4:23 PM	8:23 PM
219 Rte 155 @ Trestle Way	11:24 AM	4:24 PM	8:24 PM
236 116 Silver Street	11:25 AM	4:25 PM	8:25 PM
237 Silver Street @ Elm Street	11:25 AM	4:25 PM	8:25 PM
250 Central Ave @ Central Towers	11:27 AM	4:27 PM	8:27 PM
239 Main Street @ Janetos	11:30 AM	4:30 PM	8:30 PM
209 Central Ave @ New York Street	11:31 AM	4:31 PM	8:31 PM
207 Central Ave @ Tasker Funeral Home	11:31 AM	4:31 PM	8:31 PM
210 Central Ave @ Oak Street	11:32 AM	4:32 PM	8:32 PM
204 Central Ave @ Wentworth Douglass Hospital	11:33 AM	4:33 PM	8:33 PM
203 Arrive Shaws	11:36 AM	4:36 PM	8:36 PM
Inbound			
203 Depart Shaws	11:36 AM	4:36 PM	8:36 PM
205 Central Ave @ Abbott Street	11:38 AM	4:38 PM	8:38 PM
206 Central Ave @ Ash Street	11:39 AM	4:39 PM	8:39 PM
208 Central Ave @ Hough Street [U-Haul]	11:40 AM	4:40 PM	8:40 PM
213 Chestnut Street @ Carswell Auto	11:41 AM	4:41 PM	8:41 PM
214 Dover Transportation Center	11:42 AM	4:42 PM	8:42 PM
212 Chestnut Street @ Riverview Apartments	11:44 AM	4:44 PM	8:44 PM
202 Central Ave @ Dover City Hall	11:46 AM	4:46 PM	8:46 PM
222 Locust Street @ Spring Street	11:48 AM	4:48 PM	8:48 PM
228 Locust Street @ Dover Children's Home	11:48 AM	4:48 PM	8:48 PM
229 Central Ave @ Rutland Street	11:49 AM	4:49 PM	8:49 PM
230 Rte 108 @ Dover High School	11:51 AM	4:51 PM	8:51 PM
231 Rte 108 @ Bellamy Rd	11:51 AM	4:51 PM	8:51 PM
232 Rte 108 @ Grapevine Drive	11:51 AM	4:51 PM	8:51 PM
242 Rte 108 @ Farmwood Village	11:52 AM	4:52 PM	8:52 PM
809 Rte 108 @ Freshet Rd	11:52 AM	4:52 PM	8:52 PM
145 Rte 108 @ Canney Rd	11:54 AM	4:54 PM	8:54 PM
119 Rte 108 @ The Pines Inn (#47)	11:55 AM	4:55 PM	8:55 PM
108 Rte 108 @ Young Drive	11:56 AM	4:56 PM	8:56 PM
117 Madbury Road @ Woodman Rd	11:58 AM	4:58 PM	8:58 PM
116 ARRIVE Garrison Ave @ Sawyer Hall	11:59 AM	4:59 PM	8:59 PM
105 ARRIVE Holloway Commons Main Street	12:01 PM	5:01 PM	9:01 PM
1001 ARRIVE UNH McConnell Hall	12:03 PM	5:03 PM	9:03 PM

These times are approximate. Please be at the bus stop 5 minutes before the scheduled time.

There is no service on Sundays

There is no weekend service during periods of "Reduced Service"

Route 3B Weekday

Dover 3B

UNH/Durham to Dover via Route 155 /

Reduced Service

Dover to UNH/Durham via Route 108

Monday - Friday

Stop ID # & Location	Run 1	Run 2	Run 3
Outbound			
101 DEPART UNH McCONNELL HALL	6:40 AM	2:05 PM	4:35 PM
102 DEPART UNH KINGSBURY HALL	6:42 AM	2:07 PM	4:37 PM
103 DEPART UNH HEWITT HALL	6:42 AM	2:07 PM	4:37 PM
104 DEPART MAIN STREET @ UNH THOMPSON HALL	6:45 AM	2:10 PM	4:40 PM
106 DEPART MAIN STREET @ UNH HETZEL HALL	6:47 AM	2:12 PM	4:42 PM
117 Madbury Road @ Woodman Rd	6:48 AM	2:13 PM	4:43 PM
115 30 Madbury Rd	6:48 AM	2:13 PM	4:43 PM
118 Madbury Road @ Bagdad Woods	6:49 AM	2:14 PM	4:44 PM
182 Madbury Road @ Davis Court Apartments	6:49 AM	2:14 PM	4:44 PM
112 90 Madbury Rd	6:49 AM	2:14 PM	4:44 PM
146 Madbury Road @ Emerson Rd	6:49 AM	2:14 PM	4:44 PM
110 Madbury Road @ Pendexter Rd	6:51 AM	2:16 PM	4:46 PM
802 Madbury Road @ Rte 155	6:54 AM	2:19 PM	4:49 PM
804 Rte 155 @ Garlands Garage	6:55 AM	2:20 PM	4:50 PM
806 Rte 155 @ 280 Knox Marsh Rd	6:56 AM	2:21 PM	4:51 PM
216 Rte 155 @ Olde Madbury Lane Apartments	6:56 AM	2:21 PM	4:51 PM
217 Rte 155 @ Lilac Garden Apartments	6:57 AM	2:22 PM	4:52 PM
218 Rte 155 @ Westgate Apartments	6:58 AM	2:23 PM	4:53 PM
219 Rte 155 @ Trestle Way	6:59 AM	2:24 PM	4:54 PM
236 116 Silver Street	7:00 AM	2:25 PM	4:55 PM
237 Silver Street @ Elm Street	7:00 AM	2:25 PM	4:55 PM
250 Central Ave @ Central Towers	7:02 AM	2:27 PM	4:57 PM
239 Main Street @ Janetos	7:05 AM	2:30 PM	5:00 PM
209 Central Ave @ New York Street	7:06 AM	2:31 PM	5:01 PM
207 Central Ave @ Tasker Funeral Home	7:06 AM	2:31 PM	5:01 PM
210 Central Ave @ Oak Street	7:07 AM	2:32 PM	5:02 PM
204 Central Ave @ Wentworth Douglass Hospital	7:08 AM	2:33 PM	5:03 PM
203 Arrive Shaws	7:11 AM	2:36 PM	5:06 PM
Inbound			
203 Depart Shaws	7:11 AM	2:36 PM	5:06 PM
205 Central Ave @ Abbott Street	7:13 AM	2:38 PM	5:08 PM
206 Central Ave @ Ash Street	7:14 AM	2:39 PM	5:09 PM
208 Central Ave @ Hough Street [U-Haul]	7:15 AM	2:40 PM	5:10 PM
213 Chestnut Street @ Carswell Auto	7:16 AM	2:41 PM	5:11 PM
214 Dover Transportation Center	7:17 AM	2:42 PM	5:12 PM
212 Chestnut Street @ Riverview Apartments	7:19 AM	2:44 PM	5:14 PM
202 Central Ave @ Dover City Hall	7:21 AM	2:46 PM	5:16 PM
222 Locust Street @ Spring Street	7:23 AM	2:48 PM	5:18 PM
228 Locust Street @ Dover Children's Home	7:23 AM	2:48 PM	5:18 PM
229 Central Ave @ Rutland Street	7:24 AM	2:49 PM	5:19 PM
230 Rte 108 @ Dover High School	7:26 AM	2:51 PM	5:21 PM
231 Rte 108 @ Bellamy Rd	7:26 AM	2:51 PM	5:21 PM
232 Rte 108 @ Grapevine Drive	7:26 AM	2:51 PM	5:21 PM
242 Rte 108 @ Farmwood Village	7:27 AM	2:52 PM	5:22 PM
809 Rte 108 @ Freshet Rd	7:27 AM	2:52 PM	5:22 PM
145 Rte 108 @ Canney Road	7:29 AM	2:54 PM	5:24 PM
119 Rte 108 @ The Pines Inn (#47)	7:30 AM	2:55 PM	5:25 PM
108 Rte 108 @ Young Drive	7:31 AM	2:56 PM	5:26 PM
117 Madbury Road @ Woodman Rd	7:33 AM	2:58 PM	5:28 PM
116 ARRIVE Garrison Ave @ Sawyer Hall	7:34 AM	2:59 PM	5:29 PM
105 ARRIVE Holloway Commons Main Street	7:36 AM	3:01 PM	5:31 PM
1001 ARRIVE UNH McConnell Hall	7:38 AM	3:03 PM	5:33 PM

These times are approximate. Please be at the bus stop 5 minutes before the scheduled time.

Route 3B Weekday

Dover 3B

UNH/Durham to Dover via Route 155 / Dover to UNH/Durham via Route 108

Monday - Friday

Stop ID # & Location

Outbound	Run 1	Run 2	Run 3	Run 4	Run 5	Run 6	Run 7	Run 8
101 DEPART UNH McCONNELL HALL	6:40 AM	7:45 AM	10:05 AM	12:05 PM	2:05 PM	4:35 PM	6:05 PM	9:35 PM
102 DEPART UNH KINGSBURY HALL	6:42 AM	7:47 AM	10:07 AM	12:07 PM	2:07 PM	4:37 PM	6:07 PM	9:37 PM
103 DEPART UNH HEWITT HALL	6:42 AM	7:47 AM	10:07 AM	12:07 PM	2:07 PM	4:37 PM	6:07 PM	9:37 PM
104 DEPART MAIN STREET @ UNH THOMPSON HALL	6:45 AM	7:50 AM	10:10 AM	12:10 PM	2:10 PM	4:40 PM	6:10 PM	9:40 PM
106 DEPART MAIN STREET @ UNH HETZEL HALL	6:47 AM	7:52 AM	10:12 AM	12:12 PM	2:12 PM	4:42 PM	6:12 PM	9:42 PM
117 Madbury Road @ Woodman Rd	6:48 AM	7:53 AM	10:13 AM	12:13 PM	2:13 PM	4:43 PM	6:13 PM	9:43 PM
115 30 Madbury Rd	6:48 AM	7:53 AM	10:13 AM	12:13 PM	2:13 PM	4:43 PM	6:13 PM	9:43 PM
118 Madbury Road @ Bagdad Woods	6:49 AM	7:54 AM	10:14 AM	12:14 PM	2:14 PM	4:44 PM	6:14 PM	9:44 PM
182 Madbury Road @ Davis Court Apartments	6:49 AM	7:54 AM	10:14 AM	12:14 PM	2:14 PM	4:44 PM	6:14 PM	9:44 PM
112 90 Madbury Rd	6:49 AM	7:54 AM	10:14 AM	12:14 PM	2:14 PM	4:44 PM	6:14 PM	9:44 PM
146 Madbury Road @ Emerson Rd	6:49 AM	7:54 AM	10:14 AM	12:14 PM	2:14 PM	4:44 PM	6:14 PM	9:44 PM
110 Madbury Road @ Pendexter Rd	6:51 AM	7:56 AM	10:16 AM	12:16 PM	2:16 PM	4:46 PM	6:16 PM	9:46 PM
802 Madbury Road @ Rte 155	6:54 AM	7:59 AM	10:19 AM	12:19 PM	2:19 PM	4:49 PM	6:19 PM	9:49 PM
804 Rte 155 @ Garlands Garage	6:55 AM	8:00 AM	10:20 AM	12:20 PM	2:20 PM	4:50 PM	6:20 PM	9:50 PM
806 Rte 155 @ 280 Knox Marsh Rd	6:56 AM	8:01 AM	10:21 AM	12:21 PM	2:21 PM	4:51 PM	6:21 PM	9:51 PM
216 Rte 155 @ Olde Madbury Lane Apartments	6:56 AM	8:01 AM	10:21 AM	12:21 PM	2:21 PM	4:51 PM	6:21 PM	9:51 PM
217 Rte 155 @ Lilac Garden Apartments	6:57 AM	8:02 AM	10:22 AM	12:22 PM	2:22 PM	4:52 PM	6:22 PM	9:52 PM
218 Rte 155 @ Westgate Apartments	6:58 AM	8:03 AM	10:23 AM	12:23 PM	2:23 PM	4:53 PM	6:23 PM	9:53 PM
219 Rte 155 @ Trestle Way	6:59 AM	8:04 AM	10:24 AM	12:24 PM	2:24 PM	4:54 PM	6:24 PM	9:54 PM
236 116 Silver Street	7:00 AM	8:05 AM	10:25 AM	12:25 PM	2:25 PM	4:55 PM	6:25 PM	9:55 PM
237 Silver Street @ Elm Street	7:00 AM	8:05 AM	10:25 AM	12:25 PM	2:25 PM	4:55 PM	6:25 PM	9:55 PM
250 Central Ave @ Central Towers	7:02 AM	8:07 AM	10:27 AM	12:27 PM	2:27 PM	4:57 PM	6:27 PM	9:57 PM
239 Main Street @ Janetos	7:05 AM	8:10 AM	10:30 AM	12:30 PM	2:30 PM	5:00 PM	6:30 PM	10:00 PM
209 Central Ave @ New York Street	7:06 AM	8:11 AM	10:31 AM	12:31 PM	2:31 PM	5:01 PM	6:31 PM	10:01 PM
207 Central Ave @ Tasker Funeral Home	7:06 AM	8:11 AM	10:31 AM	12:31 PM	2:31 PM	5:01 PM	6:31 PM	10:01 PM
210 Central Ave @ Oak Street	7:07 AM	8:12 AM	10:32 AM	12:32 PM	2:32 PM	5:02 PM	6:32 PM	10:02 PM
204 Central Ave @ Wentworth Douglass Hospital	7:08 AM	8:13 AM	10:33 AM	12:33 PM	2:33 PM	5:03 PM	6:33 PM	10:03 PM
203 Arrive Shaws	7:11 AM	8:16 AM	10:36 AM	12:36 PM	2:36 PM	5:06 PM	6:36 PM	10:06 PM
Inbound								
203 Depart Shaws	7:11 AM	8:16 AM	10:36 AM	12:36 PM	2:36 PM	5:06 PM	6:36 PM	10:06 PM
205 Central Ave @ Abbott Street	7:13 AM	8:18 AM	10:38 AM	12:38 PM	2:38 PM	5:08 PM	6:38 PM	10:08 PM
206 Central Ave @ Ash Street	7:14 AM	8:19 AM	10:39 AM	12:39 PM	2:39 PM	5:09 PM	6:39 PM	10:09 PM
208 Central Ave @ Hough Street [U-Haul]	7:15 AM	8:20 AM	10:40 AM	12:40 PM	2:40 PM	5:10 PM	6:40 PM	10:10 PM
213 Chestnut Street @ Carswell Auto	7:16 AM	8:21 AM	10:41 AM	12:41 PM	2:41 PM	5:11 PM	6:41 PM	10:11 PM
214 Dover Transportation Center	7:17 AM	8:22 AM	10:42 AM	12:42 PM	2:42 PM	5:12 PM	6:42 PM	10:12 PM
212 Chestnut Street @ Riverview Apartments	7:19 AM	8:24 AM	10:44 AM	12:44 PM	2:44 PM	5:14 PM	6:44 PM	10:14 PM
202 Central Ave @ Dover City Hall	7:21 AM	8:26 AM	10:46 AM	12:46 PM	2:46 PM	5:16 PM	6:46 PM	10:16 PM
222 Locust Street @ Spring Street	7:23 AM	8:28 AM	10:48 AM	12:48 PM	2:48 PM	5:18 PM	6:48 PM	10:18 PM
228 Locust Street @ Dover Children's Home	7:23 AM	8:28 AM	10:48 AM	12:48 PM	2:48 PM	5:18 PM	6:48 PM	10:18 PM
229 Central Ave @ Rutland Street	7:24 AM	8:29 AM	10:49 AM	12:49 PM	2:49 PM	5:19 PM	6:49 PM	10:19 PM
230 Rte 108 @ Dover High School	7:26 AM	8:31 AM	10:51 AM	12:51 PM	2:51 PM	5:21 PM	6:51 PM	10:21 PM
231 Rte 108 @ Bellamy Rd	7:26 AM	8:31 AM	10:51 AM	12:51 PM	2:51 PM	5:21 PM	6:51 PM	10:21 PM
232 Rte 108 @ Grapevine Drive	7:26 AM	8:31 AM	10:51 AM	12:51 PM	2:51 PM	5:21 PM	6:51 PM	10:21 PM
242 Rte 108 @ Farmwood Village	7:27 AM	8:32 AM	10:52 AM	12:52 PM	2:52 PM	5:22 PM	6:52 PM	10:22 PM
809 Rte 108 @ Freshet Rd	7:27 AM	8:32 AM	10:52 AM	12:52 PM	2:52 PM	5:22 PM	6:52 PM	10:22 PM
145 Rte 108 @ Canney Rd	7:29 AM	8:34 AM	10:54 AM	12:54 PM	2:54 PM	5:24 PM	6:54 PM	10:24 PM
119 Rte 108 @ The Pines Inn (#47)	7:30 AM	8:35 AM	10:55 AM	12:55 PM	2:55 PM	5:25 PM	6:55 PM	10:25 PM
108 Rte 108 @ Young Drive	7:31 AM	8:36 AM	10:56 AM	12:56 PM	2:56 PM	5:26 PM	6:56 PM	10:26 PM
117 Madbury Road @ Woodman Rd	7:33 AM	8:38 AM	10:58 AM	12:58 PM	2:58 PM	5:28 PM	6:58 PM	10:28 PM
116 ARRIVE Garrison Ave @ Sawyer Hall	7:34 AM	8:39 AM	10:59 AM	12:59 PM	2:59 PM	5:29 PM	6:59 PM	10:29 PM
105 ARRIVE Holloway Commons Main Street	7:36 AM	8:41 AM	11:01 AM	1:01 PM	3:01 PM	5:31 PM	7:01 PM	10:31 PM
1001 ARRIVE UNH McConnell Hall	7:38 AM	8:43 AM	11:03 AM	1:03 PM	3:03 PM	5:33 PM	7:03 PM	10:33 PM

These times are approximate. Please be at the bus stop 5 minutes before the scheduled time.

Travel Direction

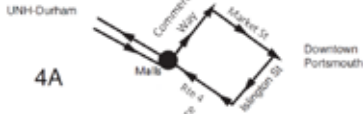

4A

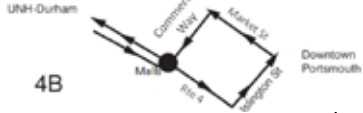

4B

Wildcat Transit - Portsmouth Route 4

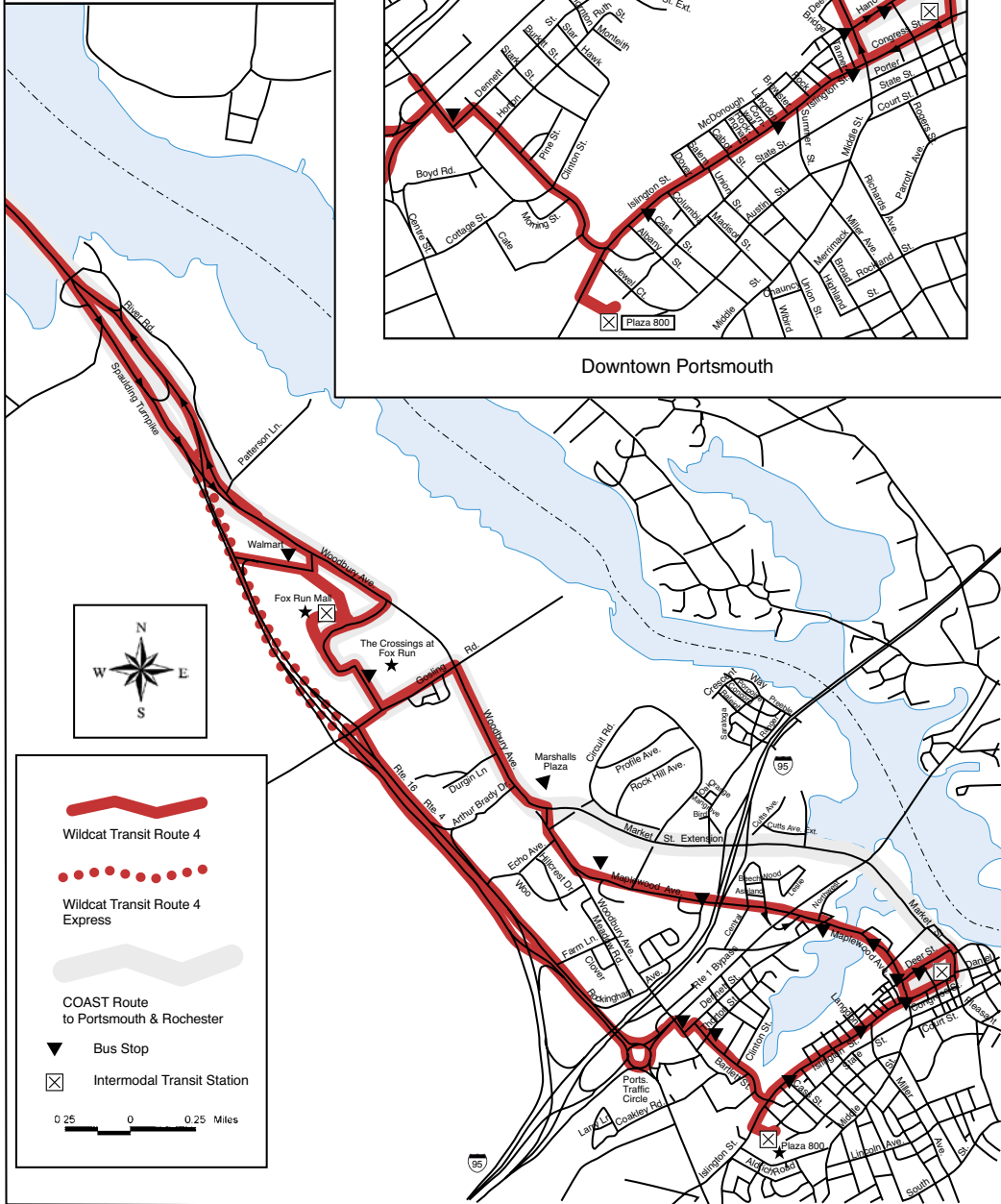

Route 4A WEEKEND Portsmouth 4A
UNH/Durham to Malls & Portsmouth Market Square Saturday - Sunday

Stop ID # & Location			
Outbound	Run 1	Run 2	Run 3
101 DEPART UNH McCONNELL HALL	11:35 AM	2:35 PM	7:05 PM
102 DEPART UNH KINGSBURY HALL	11:37 AM	2:37 PM	7:07 PM
103 DEPART UNH HEWITT HALL	11:37 AM	2:37 PM	7:07 PM
104 DEPART MAIN STREET @ UNH THOMPSON HALL	11:40 AM	2:40 PM	7:10 PM
106 DEPART MAIN STREET @ UNH HETZEL HALL	11:42 AM	2:42 PM	7:12 PM
107 Rte 108 @ Old Landing Rd	11:44 AM	2:44 PM	7:14 PM
109 Rte 108 @ Old Piscataqua Rd	11:44 AM	2:44 PM	7:14 PM
121 Rte 4 @ 68 Piscataqua Rd	11:45 AM	2:45 PM	7:15 PM
122 Rte 4 @ Riverview Rd	11:46 AM	2:46 PM	7:16 PM
192 Rte 4 @ 116 Piscataqua Rd	11:46 AM	2:46 PM	7:16 PM
123 Rte 4 @ Wagon Hill Farm	11:47 AM	2:47 PM	7:17 PM
124 Rte 4 @ Cedar Point Rd	11:48 AM	2:48 PM	7:18 PM
201 Boston Harbor Road @ DMV	On Request Only		
604 Newington Wal-Mart	11:56 AM	2:56 PM	7:26 PM
603 Fox Run Mall (to Portsmouth)	11:58 AM	2:58 PM	7:28 PM
601 Crossings at Fox Run @ Cold Stone Creamery	12:01 PM	3:01 PM	7:30 PM
302 Gosling Rd @ Gosling Meadows	12:03 PM	3:03 PM	7:32 PM
314 1840 Woodbury Ave	12:04 PM	3:04 PM	7:33 PM
312 Marshall's Plaza @ Commerce Way	12:07 PM	3:07 PM	7:36 PM
336 170 Commerce Way	12:08 PM	3:08 PM	7:37 PM
338 Commerce Way / Portsmouth Blvd	12:08 PM	3:08 PM	7:37 PM
316 Maplewood Ave @ Fairview Drive	12:12 PM	3:12 PM	7:39 PM
317 Maplewood Ave @ I-95 Overpass	12:14 PM	3:14 PM	7:41 PM
318 Maplewood Ave @ Dearborn Street	12:15 PM	3:15 PM	7:42 PM
319 Maplewood Ave @ North Cemetery	12:16 PM	3:16 PM	7:43 PM
303 Hanover Street @ High-Hanover Parking Facility	12:18 PM	3:18 PM	7:45 PM
311 Arrive Market Square	12:20 PM	3:20 PM	7:47 PM
Inbound			
311 Depart Market Square	12:20 PM	3:20 PM	7:47 PM
310 Islington Street @ Tanner Street	12:21 PM	3:21 PM	7:49 PM
308 Islington Street @ Cornwall Street	12:22 PM	3:22 PM	7:50 PM
307 Islington Street @ Dunkin Donuts	12:24 PM	3:24 PM	7:51 PM
305 Plaza 800	12:25 PM	3:25 PM	7:53 PM
320 Bartlett Street @ Meredith Way	12:28 PM	3:28 PM	7:56 PM
321 Dennett Street @ Woodbury Ave	12:29 PM	3:29 PM	7:56 PM
602 Crossings at Fox Run @ Regal Cinemas	12:36 PM	3:36 PM	8:01 PM
606 Fox Run Mall (to UNH)	12:40 PM	3:40 PM	8:05 PM
605 Fox Run Rd @ Wal-Mart	12:42 PM	3:42 PM	8:07 PM
607 2299 Woodbury Ave	12:42 PM	3:42 PM	8:08 PM
201 Boston Harbor Road @ DMV	On Request Only		
125 Rte 4 @ Scammel Bridge (West Side)	12:48 PM	3:48 PM	8:14 PM
126 Rte 4 @ Emery Farm	12:50 PM	3:50 PM	8:15 PM
193 Rte 4 @ Morgan Way	12:50 PM	3:50 PM	8:16 PM
127 Rte 4 @ Shearwater Street	12:51 PM	3:51 PM	8:17 PM
120 Rte 4 @ 65 Piscataqua Road	12:52 PM	3:52 PM	8:17 PM
119 Rte 108 @ The Pines Inn (#47)	12:55 PM	3:55 PM	8:20 PM
108 Rte 108 @ Young Drive	12:55 PM	3:55 PM	8:21 PM
117 Madbury Road @ Woodman Rd	12:57 PM	3:57 PM	8:23 PM
116 ARRIVE Garrison Ave @ Sawyer Hall	12:59 PM	3:59 PM	8:24 PM
105 ARRIVE Holloway Commons Main Street	1:00 PM	4:00 PM	8:26 PM
1001 ARRIVE UNH McConnell Hall	1:02 PM	4:02 PM	8:28 PM

These times are approximate. Please be at the bus stop 5 minutes before the scheduled time.

There is no weekend service during periods of "Reduced Service"

Route 4A WEEKDAY

Portsmouth 4A

Reduced Service

UNH/Durham to Malls & Portsmouth Market Square

Monday - Friday

Stop ID # & Location	AM Express	
	Run 1	Run 6
Outbound		
101 DEPART UNH McCONNELL HALL	6:40 AM	6:05 PM
102 DEPART UNH KINGSBURY HALL	6:42 AM	6:07 PM
103 DEPART UNH HEWITT HALL	6:42 AM	6:07 PM
104 DEPART MAIN ST @ UNH THOMPSON HALL	6:45 AM	6:10 PM
106 DEPART MAIN STREET @ UNH HETZEL HALL	6:47 AM	6:12 PM
107 Rte 108 @ Old Landing Rd	6:49 AM	6:14 PM
109 Rte 108 @ Old Piscataqua Rd	6:49 AM	6:14 PM
121 Rte 4 @ 68 Piscataqua Rd	Depending on Rte 4 traffic, these stops may not be serviced. The bus may detoured to avoid heavy traffic. Call 603-862-2328 for daily information.	6:15 PM
122 Rte 4 @ Riverview Rd		6:16 PM
192 Rte 4 @ 116 Piscataqua Rd		6:16 PM
123 Rte 4 @ Wagon Hill Farm		6:17 PM
124 Rte 4 @ Cedar Point Rd		6:18 PM
201 Boston Harbor Road @ DMV	On Request Only	
604 Newington Wal-Mart	Not Serviced on This Run	6:26 PM
603 Fox Run Mall (to Portsmouth)		6:28 PM
601 Crossings at Fox Run @ Cold Stone Creamery		6:31 PM
302 Gosling Rd @ Gosling Meadows		6:33 PM
314 1840 Woodbury Ave	7:01 AM	6:34 PM
312 Marshall's Plaza @ Commerce Way	7:03 AM	6:37 PM
336 170 Commerce Way	7:04 AM	6:38 PM
338 Commerce Way / Portsmouth Blvd	7:05 AM	6:38 PM
316 Maplewood Ave @ Fairview Drive	7:08 AM	6:42 PM
317 Maplewood Ave @ I-95 Overpass	7:10 AM	6:44 PM
318 Maplewood Ave @ Dearborn Street	7:11 AM	6:45 PM
319 Maplewood Ave @ North Cemetery	7:12 AM	6:46 PM
303 Hanover Street @ High-Hanover Parking Facility	7:14 AM	6:48 PM
311 Arrive Market Square	7:16 AM	6:50 PM
Inbound		
311 Depart Market Square	7:16 AM	6:50 PM
310 Islington Street @ Tanner Street	7:17 AM	6:51 PM
308 Islington Street @ Cornwall Street	7:18 AM	6:52 PM
307 Islington Street @ Dunkin Donuts	7:20 AM	6:54 PM
305 Plaza 800	7:21 AM	6:55 PM
320 Bartlett Street @ Meredith Way	7:24 AM	6:58 PM
321 Dennett Street @ Woodbury Ave	7:25 AM	6:59 PM
201 Boston Harbor Road @ DMV	On Request Only	
125 Rte 4 @ Scammel Bridge (West Side)	7:34 AM	7:08 PM
126 Rte 4 @ Emery Farm	7:36 AM	7:09 PM
193 Rte 4 @ Morgan Way	7:37 AM	7:10 PM
127 Rte 4 @ Shearwater Street	7:37 AM	7:10 PM
120 Rte 4 @ 65 Piscataqua Rd	7:37 AM	7:11 PM
119 Rte 108 @ The Pines Inn (#47)	7:40 AM	7:14 PM
108 Rte 108 @ Young Drive	7:40 AM	7:14 PM
117 Madbury Road @ Woodman Rd	7:43 AM	7:17 PM
116 ARRIVE Garrison Ave @ Sawyer Hall	7:44 AM	7:18 PM
105 ARRIVE Holloway Commons Main Street	7:46 AM	7:20 PM
1001 ARRIVE UNH McConnell Hall	7:48 AM	7:22 PM

These times are approximate. Please be at the bus stop 5 minutes before the scheduled time.

There is no service on weekends during periods of Reduced Service

Route 4A Weekday UNH/Durham to Malls & Portsmouth Market Square

Portsmouth 4A Monday - Friday

Stop ID # & Location	AM Express		AM Express				
	Run 1	Run 2	Run 3	Run 4	Run 5	Run 6	Run 7
Outbound							
101 DEPART UNH McCONNELL HALL	6:40 AM	7:45 AM	12:05 PM	2:05 PM	6:05 PM	7:05 PM	9:35 PM
102 DEPART UNH KINGSBURY HALL	6:42 AM	7:47 AM	12:07 PM	2:07 PM	6:07 PM	7:07 PM	9:37 PM
103 DEPART UNH HEWITT HALL	6:42 AM	7:47 AM	12:07 PM	2:07 PM	6:07 PM	7:07 PM	9:37 PM
104 DEPART MAIN STREET @ UNH THOMPSON HALL	6:45 AM	7:50 AM	12:10 PM	2:10 PM	6:10 PM	7:10 PM	9:40 PM
106 DEPART MAIN STREET @ UNH HETZEL HALL	6:47 AM	7:52 AM	12:12 PM	2:12 PM	6:12 PM	7:12 PM	9:42 PM
107 Rte 108 @ Old Landing Rd	6:49 AM	7:54 AM	12:14 PM	2:14 PM	6:14 PM	7:14 PM	9:44 PM
109 Rte 108 @ Old Piscataqua Rd	6:49 AM	7:54 AM	12:14 PM	2:14 PM	6:14 PM	7:14 PM	9:44 PM
121 Rte 4 @ 68 Piscataqua Rd	Depending on traffic, stops on Route 4 may not be serviced outbound before 9 am. Please call 603-862-2328 for daily information.		12:15 PM	2:15 PM	6:15 PM	7:15 PM	9:45 PM
122 Rte 4 @ Riverview Rd			12:16 PM	2:16 PM	6:16 PM	7:16 PM	9:46 PM
192 Rte 4 @ 116 Piscataqua Rd			12:16 PM	2:16 PM	6:16 PM	7:16 PM	9:46 PM
123 Rte 4 @ Wagon Hill Farm			12:17 PM	2:17 PM	6:17 PM	7:17 PM	9:47 PM
124 Rte 4 @ Cedar Point Rd			12:18 PM	2:18 PM	6:18 PM	7:18 PM	9:48 PM
201 Boston Harbor Road @ DMV	On Request Only		On Request Only		On Request Only		
604 Newington Wal-Mart	Not Serviced on These Runs		12:26 PM	2:26 PM	6:26 PM	7:26 PM	9:56 PM
603 Fox Run Mall (to Portsmouth)	Not Serviced on These Runs		12:28 PM	2:28 PM	6:28 PM	7:28 PM	9:58 PM
601 Crossings at Fox Run @ Cold Stone Creamery	Not Serviced on These Runs		12:31 PM	2:31 PM	6:31 PM	7:31 PM	10:01 PM
302 Gosling Rd @ Gosling Meadows	Not Serviced on These Runs		12:33 PM	2:33 PM	6:33 PM	7:33 PM	10:03 PM
314 1840 Woodbury Ave	7:01 AM	8:06 AM	12:34 PM	2:34 PM	6:34 PM	7:34 PM	10:04 PM
312 Marshall's Plaza @ Commerce Way	7:03 AM	8:08 AM	12:37 PM	2:37 PM	6:37 PM	7:37 PM	10:07 PM
336 170 Commerce Way	7:04 AM	8:09 AM	12:38 PM	2:38 PM	6:38 PM	7:38 PM	10:08 PM
338 Commerce Way / Portsmouth Blvd	7:05 AM	8:10 AM	12:38 PM	2:38 PM	6:38 PM	7:38 PM	10:08 PM
316 Maplewood Ave @ Fairview Drive	7:08 AM	8:13 AM	12:42 PM	2:42 PM	6:42 PM	7:42 PM	10:10 PM
317 Maplewood Ave @ I-95 Overpass	7:10 AM	8:15 AM	12:44 PM	2:44 PM	6:44 PM	7:44 PM	10:12 PM
318 Maplewood Ave @ Dearborn Street	7:11 AM	8:16 AM	12:45 PM	2:45 PM	6:45 PM	7:45 PM	10:13 PM
319 Maplewood Ave @ North Cemetery	7:12 AM	8:17 AM	12:46 PM	2:46 PM	6:46 PM	7:46 PM	10:14 PM
303 Hanover Street @ High-Hanover Parking Facility	7:14 AM	8:19 AM	12:48 PM	2:48 PM	6:48 PM	7:48 PM	10:16 PM
311 Arrive Market Square	7:16 AM	8:21 AM	12:50 PM	2:50 PM	6:50 PM	7:50 PM	10:18 PM
Inbound							
311 Depart Market Square	7:16 AM	8:21 AM	12:50 PM	2:50 PM	6:50 PM	7:50 PM	10:18 PM
310 Islington Street @ Tanner Street	7:18 AM	8:23 AM	12:51 PM	2:51 PM	6:51 PM	7:51 PM	10:19 PM
308 Islington Street @ Cornwall Street	7:19 AM	8:24 AM	12:52 PM	2:52 PM	6:52 PM	7:52 PM	10:20 PM
307 Islington Street @ Dunkin Donuts	7:20 AM	8:25 AM	12:54 PM	2:54 PM	6:54 PM	7:54 PM	10:22 PM
305 Plaza 800	7:22 AM	8:27 AM	12:55 PM	2:55 PM	6:55 PM	7:55 PM	10:23 PM
320 Bartlett Street @ Meredith Way	7:25 AM	8:30 AM	12:58 PM	2:58 PM	6:58 PM	7:58 PM	10:26 PM
321 Dennett Street @ Woodbury Ave	7:26 AM	8:31 AM	12:59 PM	2:59 PM	6:59 PM	7:59 PM	10:27 PM
201 Boston Harbor Road @ DMV	On Request Only		On Request Only		On Request Only		
125 Rte 4 @ Scammel Bridge (West Side)	7:35 AM	8:40 AM	1:09 PM	3:09 PM	7:09 PM	8:09 PM	10:36 PM
126 Rte 4 @ Emery Farm	7:37 AM	8:42 AM	1:10 PM	3:10 PM	7:10 PM	8:10 PM	10:38 PM
193 Rte 4 @ Morgan Way	7:37 AM	8:42 AM	1:11 PM	3:11 PM	7:11 PM	8:11 PM	10:38 PM
127 Rte 4 @ Shearwater Street	7:38 AM	8:43 AM	1:11 PM	3:11 PM	7:11 PM	8:11 PM	10:39 PM
120 Rte 4 @ 65 Piscataqua Rd	7:38 AM	8:43 AM	1:11 PM	3:11 PM	7:11 PM	8:11 PM	10:39 PM
119 Rte 108 @ The Pines Inn (#47)	7:41 AM	8:46 AM	1:14 PM	3:14 PM	7:14 PM	8:14 PM	10:42 PM
108 Rte 108 @ Young Drive	7:41 AM	8:46 AM	1:15 PM	3:15 PM	7:15 PM	8:15 PM	10:42 PM
117 Madbury Road @ Woodman Rd	7:44 AM	8:49 AM	1:18 PM	3:17 PM	7:17 PM	8:17 PM	10:44 PM
116 ARRIVE Garrison Ave @ Sawyer Hall	7:45 AM	8:50 AM	1:19 PM	3:19 PM	7:19 PM	8:19 PM	10:46 PM
105 ARRIVE Holloway Commons Main Street	7:47 AM	8:52 AM	1:21 PM	3:20 PM	7:20 PM	8:20 PM	10:47 PM
1001 ARRIVE UNH McConnell Hall	7:49 AM	8:54 AM	1:23 PM	3:22 PM	7:22 PM	8:22 PM	10:49 PM

These times are approximate. Please be at the bus stop 5 minutes before the scheduled time.

Route 4B WEEKEND

Portsmouth 4B

UNH / Durham to Malls & Portsmouth Market Square

Saturday - Sunday

Stop ID # & Location				
Outbound	Run 1	Run 2	Run 3	Run 4
101 DEPART UNH McCONNELL HALL	1:05 PM	3:35 PM	5:05 PM	9:05 PM
102 DEPART UNH KINGSBURY HALL	1:07 PM	3:37 PM	5:07 PM	9:07 PM
103 DEPART UNH HEWITT HALL	1:07 PM	3:37 PM	5:07 PM	9:07 PM
HALL	1:10 PM	3:40 PM	5:10 PM	9:10 PM
106 DEPART MAIN STREET @ UNH HETZEL HALL	1:12 PM	3:42 PM	5:12 PM	9:12 PM
107 Rte 108 @ Old Landing Rd	1:14 PM	3:44 PM	5:14 PM	9:14 PM
109 Rte 108 @ Old Piscataqua Rd	1:14 PM	3:44 PM	5:14 PM	9:14 PM
121 Rte 4 @ 68 Piscataqua Rd	1:15 PM	3:45 PM	5:15 PM	9:15 PM
122 Rte 4 @ Riverview Rd	1:16 PM	3:46 PM	5:16 PM	9:16 PM
192 Rte 4 @ 116 Piscataqua Rd	1:16 PM	3:46 PM	5:16 PM	9:16 PM
123 Rte 4 @ Wagon Hill Farm	1:17 PM	3:47 PM	5:17 PM	9:17 PM
124 Rte 4 @ Cedar Point Rd	1:18 PM	3:48 PM	5:18 PM	9:18 PM
201 Boston Harbor Road @ DMV	On Request Only			
604 Newington Wal-Mart	1:26 PM	3:56 PM	5:26 PM	9:26 PM
603 Fox Run Mall (To Portsmouth)	1:28 PM	3:58 PM	5:28 PM	9:28 PM
601 Crossings at Fox Run @ Cold Stone Creamery	1:31 PM	4:01 PM	5:31 PM	9:31 PM
322 676 Dennett Street	1:38 PM	4:08 PM	5:38 PM	9:38 PM
323 Bartlett Street @ Thornton Street	1:39 PM	4:09 PM	5:39 PM	9:39 PM
305 Plaza 800	1:42 PM	4:12 PM	5:42 PM	9:42 PM
306 Islington Street @ Cass Street	1:44 PM	4:14 PM	5:44 PM	9:44 PM
304 Islington Street @ Goodwin Park	1:45 PM	4:15 PM	5:45 PM	9:45 PM
309 Islington Street @ Keefe House	1:46 PM	4:16 PM	5:46 PM	9:46 PM
303 Hanover Street @ High-Hanover Parking Facility	1:48 PM	4:18 PM	5:48 PM	9:48 PM
311 Arrive Market Square	1:50 PM	4:20 PM	5:50 PM	9:50 PM
Inbound				
311 Depart Market Square	1:50 PM	4:20 PM	5:50 PM	9:50 PM
324 Maplewood Ave @ Vaughan Street	1:52 PM	4:22 PM	5:52 PM	9:52 PM
325 Maplewood Ave @ Jackson Hill St	1:53 PM	4:23 PM	5:53 PM	9:53 PM
326 651 Maplewood Ave (Odd Fellow's Lodge)	1:54 PM	4:24 PM	5:54 PM	9:54 PM
327 Maplewood Ave @ Heritage Hill	1:55 PM	4:25 PM	5:55 PM	9:55 PM
333 Portsmouth Blvd @ Shearwater Drive	2:00 PM	4:30 PM	6:00 PM	10:00 PM
334 215 Commerce Way	2:00 PM	4:30 PM	6:00 PM	10:00 PM
335 175 Commerce Way	2:01 PM	4:31 PM	6:01 PM	10:01 PM
339 Commerce Way @ Marshall's Plaza	2:02 PM	4:32 PM	6:02 PM	10:02 PM
313 1855 Woodbury Ave @ Starbucks	2:03 PM	4:33 PM	6:03 PM	10:03 PM
301 Gosling Road @ Winsor Rd	2:05 PM	4:35 PM	6:05 PM	10:05 PM
602 Crossings at Fox Run @ Regal Cinemas	2:07 PM	4:37 PM	6:07 PM	10:06 PM
606 Fox Run Mall (to UNH)	2:10 PM	4:40 PM	6:10 PM	10:09 PM
605 Fox Run Rd @ Wal-Mart	2:12 PM	4:42 PM	6:12 PM	10:11 PM
607 2299 Wodbury Ave	2:13 PM	4:43 PM	6:13 PM	10:12 PM
201 Boston Harbor Road @ DMV	On Request Only			
125 Rte 4 @ Scammel Bridge (West Side)	2:20 PM	4:50 PM	6:20 PM	10:19 PM
126 Rte 4 @ Emery Farm	2:22 PM	4:52 PM	6:22 PM	10:21 PM
193 Rte 4 @ Morgan Way	2:22 PM	4:52 PM	6:22 PM	10:22 PM
127 Rte 4 @ Shearwater Street	2:23 PM	4:53 PM	6:23 PM	10:22 PM
120 Rte 4 @ 65 Piscataqua Road	2:24 PM	4:54 PM	6:24 PM	10:23 PM
119 Rte 108 @ The Pines Inn (#47)	2:27 PM	4:57 PM	6:27 PM	10:26 PM
108 Rte 108 @ Young Drive	2:27 PM	4:57 PM	6:27 PM	10:27 PM
117 Madbury Road @ Woodman Rd	2:29 PM	4:59 PM	6:29 PM	10:29 PM
116 ARRIVE Garrison Ave @ Sawyer Hall	2:31 PM	5:01 PM	6:31 PM	10:30 PM
105 ARRIVE Holloway Commons Main Street	2:32 PM	5:02 PM	6:32 PM	10:31 PM
1001 ARRIVE UNH McConnell Hall	2:34 PM	5:04 PM	6:34 PM	10:33 PM

These times are approximate. Please be at the bus stop 5 minutes before the scheduled time.

There is no weekend service during periods of "Reduced Service"

Route 4B WEEKDAY

Portsmouth 4B Reduced Service

UNH/Durham to Malls & Portsmouth Market Square

Monday - Friday

Stop ID # & Location				
Outbound	Run 1	Run 2	Run 3	Run 4
101 DEPART UNH McCONNELL HALL	9:35 AM	1:05 PM	3:05 PM	4:35 PM
102 DEPART UNH KINGSBURY HALL	9:37 AM	1:07 PM	3:07 PM	4:37 PM
103 DEPART UNH HEWITT HALL	9:37 AM	1:07 PM	3:07 PM	4:37 PM
104 DEPART MAIN STREET @ UNH THOMPSON HALL	9:40 AM	1:10 PM	3:10 PM	4:40 PM
106 DEPART MAIN STREET @ UNH HETZEL HALL	9:42 AM	1:12 PM	3:12 PM	4:42 PM
107 Rte 108 @ Old Landing Rd	9:44 AM	1:14 PM	3:14 PM	4:44 PM
109 Rte 108 @ Old Piscataqua Rd	9:44 AM	1:14 PM	3:14 PM	4:44 PM
121 Rte 4 @ 68 Piscataqua Rd	9:45 AM	1:15 PM	3:15 PM	4:45 PM
122 Rte 4 @ Riverview Rd	9:46 AM	1:16 PM	3:16 PM	4:46 PM
192 Rte 4 @ 116 Piscataqua Rd	9:46 AM	1:16 PM	3:16 PM	4:46 PM
123 Rte 4 @ Wagon Hill Farm	9:47 AM	1:17 PM	3:17 PM	4:47 PM
124 Rte 4 @ Cedar Point Rd	9:48 AM	1:18 PM	3:18 PM	4:48 PM
201 Boston Harbor Road @ DMV	On Request Only			
322 676 Dennett Street	9:59 AM	1:27 PM	3:27 PM	4:57 PM
323 Bartlett Street @ Thornton Street	10:00 AM	1:28 PM	3:28 PM	4:58 PM
305 Plaza 800	10:03 AM	1:31 PM	3:31 PM	5:01 PM
306 Islington Street @ Cass Street	10:05 AM	1:33 PM	3:33 PM	5:03 PM
304 Islington Street @ Goodwin Park	10:06 AM	1:34 PM	3:34 PM	5:04 PM
309 Islington Street @ Keefe House	10:07 AM	1:35 PM	3:35 PM	5:05 PM
303 Hanover Street @ High-Hanover Parking Facility	10:09 AM	1:37 PM	3:37 PM	5:07 PM
311 Arrive Market Square	10:11 AM	1:39 PM	3:39 PM	5:09 PM
Inbound				
311 Depart Market Square	10:11 AM	1:39 PM	3:39 PM	5:09 PM
324 Maplewood Ave @ Vaughan Street	10:13 AM	1:41 PM	3:41 PM	5:11 PM
325 Maplewood Ave @ Jackson Hill St	10:14 AM	1:42 PM	3:42 PM	5:12 PM
326 651 Maplewood Ave (Odd Fellow's Lodge)	10:15 AM	1:43 PM	3:43 PM	5:13 PM
327 Maplewood Ave @ Heritage Hill	10:16 AM	1:44 PM	3:44 PM	5:14 PM
333 Portsmouth Blvd @ Shearwater Drive	10:21 AM	1:49 PM	3:49 PM	5:19 PM
334 215 Commerce Way	10:21 AM	1:49 PM	3:49 PM	5:19 PM
335 175 Commerce Way	10:22 AM	1:50 PM	3:50 PM	5:20 PM
339 Commerce Way @ Marshall's Plaza	10:23 AM	1:51 PM	3:51 PM	5:21 PM
313 1855 Woodbury Ave @ Starbucks	10:24 AM	1:52 PM	3:52 PM	5:22 PM
301 Gosling Road @ Winsor Rd	10:26 AM	1:54 PM	3:54 PM	5:24 PM
602 Crossings at Fox Run @ Regal Cinemas	10:28 AM	1:56 PM	3:56 PM	5:26 PM
606 Fox Run Mall (to UNH)	10:31 AM	1:59 PM	3:59 PM	5:29 PM
605 Fox Run Rd @ Wal-Mart	10:33 AM	2:01 PM	4:01 PM	5:31 PM
607 2299 Woodbury Ave	10:33 AM	2:02 PM	4:02 PM	5:32 PM
201 Boston Harbor Road @ DMV	On Request Only			
125 Rte 4 @ Scammel Bridge (West Side)	10:41 AM	2:10 PM	4:10 PM	5:40 PM
126 Rte 4 @ Emery Farm	10:43 AM	2:12 PM	4:12 PM	5:42 PM
193 Rte 4 @ Morgan Way	10:43 AM	2:12 PM	4:12 PM	5:42 PM
127 Rte 4 @ Shearwater Street	10:44 AM	2:13 PM	4:13 PM	5:43 PM
120 Rte 4 @ 65 Piscataqua Rd	10:44 AM	2:13 PM	4:13 PM	5:43 PM
119 Rte 108 @ The Pines Inn (#47)	10:47 AM	2:16 PM	4:16 PM	5:46 PM
108 Rte 108 @ Young Drive	10:48 AM	2:17 PM	4:17 PM	5:47 PM
117 Madbury Road @ Woodman Rd	10:50 AM	2:19 PM	4:19 PM	5:49 PM
116 ARRIVE Garrison Ave @ Sawyer Hall	10:51 AM	2:20 PM	4:20 PM	5:50 PM
105 ARRIVE Holloway Commons Main Street	10:52 AM	2:21 PM	4:21 PM	5:51 PM
1001 ARRIVE UNH McConnell Hall	10:54 AM	2:23 PM	4:23 PM	5:53 PM

These times are approximate. Please be at the bus stop 5 minutes before the scheduled time.

There is no service on weekends during periods of Reduced Service.

Route 4B Weekday

Portsmouth 4B

UNH/Durham to Malls & Portsmouth Market Square

Monday - Friday

Stop ID # & Location						
Outbound	Run 1	Run 2	Run 3	Run 4	Run 5	Run 6
101 DEPART UNH McCONNELL HALL	8:45 AM	10:35 AM	1:05 PM	3:05 PM	4:35 PM	8:05 PM
102 DEPART UNH KINGSBURY HALL	8:47 AM	10:37 AM	1:07 PM	3:07 PM	4:37 PM	8:07 PM
103 DEPART UNH HEWITT HALL	8:47 AM	10:37 AM	1:07 PM	3:07 PM	4:37 PM	8:07 PM
104 DEPART MAIN STREET @ UNH THOMPSON HALL	8:50 AM	10:40 AM	1:10 PM	3:10 PM	4:40 PM	8:10 PM
106 DEPART MAIN STREET @ UNH HETZEL HALL	8:52 AM	10:42 AM	1:12 PM	3:12 PM	4:42 PM	8:12 PM
107 Rte 108 @ Old Landing Rd	8:54 AM	10:44 AM	1:14 PM	3:14 PM	4:44 PM	8:14 PM
109 Rte 108 @ Old Piscataqua Rd	8:54 AM	10:44 AM	1:14 PM	3:14 PM	4:44 PM	8:14 PM
121 Rte 4 @ 68 Piscataqua Rd	8:55 AM	10:45 AM	1:15 PM	3:15 PM	4:45 PM	8:15 PM
122 Rte 4 @ Riverview Rd	8:56 AM	10:46 AM	1:16 PM	3:16 PM	4:46 PM	8:16 PM
192 Rte 4 @ 116 Piscataqua Rd	8:56 AM	10:46 AM	1:16 PM	3:16 PM	4:46 PM	8:16 PM
123 Rte 4 @ Wagon Hill Farm	8:57 AM	10:47 AM	1:17 PM	3:17 PM	4:47 PM	8:17 PM
124 Rte 4 @ Cedar Point Rd	8:58 AM	10:48 AM	1:18 PM	3:18 PM	4:48 PM	8:18 PM
201 Boston Harbor Road @ DMV	On Request Only					
322 676 Dennett Street	9:09 AM	10:57 AM	1:27 PM	3:27 PM	4:57 PM	8:27 PM
323 Bartlett Street @ Thornton Street	9:10 AM	10:58 AM	1:28 PM	3:28 PM	4:58 PM	8:28 PM
305 Plaza 800	9:13 AM	11:01 AM	1:31 PM	3:31 PM	5:01 PM	8:30 PM
306 Islington Street @ Cass Street	9:15 AM	11:03 AM	1:33 PM	3:33 PM	5:03 PM	8:32 PM
304 Islington Street @ Goodwin Park	9:16 AM	11:04 AM	1:34 PM	3:34 PM	5:04 PM	8:33 PM
309 Islington Street @ Keefe House	9:17 AM	11:05 AM	1:35 PM	3:35 PM	5:05 PM	8:34 PM
303 Hanover Street @ High-Hanover Parking Facility	9:19 AM	11:07 AM	1:37 PM	3:37 PM	5:07 PM	8:36 PM
311 Arrive Market Square	9:21 AM	11:09 AM	1:39 PM	3:39 PM	5:09 PM	8:38 PM
Inbound						
311 Depart Market Square	9:21 AM	11:09 AM	1:39 PM	3:39 PM	5:09 PM	8:38 PM
324 Maplewood Ave @ Vaughan Street	9:23 AM	11:11 AM	1:41 PM	3:41 PM	5:11 PM	8:40 PM
325 Maplewood Ave @ Jackson Hill St	9:24 AM	11:12 AM	1:42 PM	3:42 PM	5:12 PM	8:41 PM
326 651 Maplewood Ave (Odd Fellow's Lodge)	9:25 AM	11:13 AM	1:43 PM	3:43 PM	5:13 PM	8:42 PM
327 Maplewood Ave @ Heritage Hill	9:26 AM	11:14 AM	1:44 PM	3:44 PM	5:14 PM	8:43 PM
333 Portsmouth Blvd @ Shearwater Drive	9:31 AM	11:19 AM	1:49 PM	3:49 PM	5:19 PM	8:48 PM
334 215 Commerce Way	9:31 AM	11:19 AM	1:49 PM	3:49 PM	5:19 PM	8:48 PM
335 175 Commerce Way	9:32 AM	11:20 AM	1:50 PM	3:50 PM	5:20 PM	8:49 PM
339 Commerce Way @ Marshall's Plaza	9:33 AM	11:21 AM	1:51 PM	3:51 PM	5:21 PM	8:49 PM
313 1855 Woodbury Ave @ Starbucks	9:34 AM	11:22 AM	1:52 PM	3:52 PM	5:22 PM	8:50 PM
301 Gosling Road @ Winsor Rd	9:36 AM	11:24 AM	1:54 PM	3:54 PM	5:24 PM	8:52 PM
602 Crossings at Fox Run @ Regal Cinemas	9:38 AM	11:26 AM	1:56 PM	3:56 PM	5:26 PM	8:53 PM
606 Fox Run Mall (to UNH)	9:41 AM	11:29 AM	1:59 PM	3:59 PM	5:29 PM	8:56 PM
605 Fox Run Rd @ Wal-Mart	9:43 AM	11:31 AM	2:01 PM	4:01 PM	5:31 PM	8:58 PM
607 2299 Woodbury Ave	9:45 AM	11:32 AM	2:02 PM	4:02 PM	5:32 PM	8:59 PM
201 Boston Harbor Road @ DMV	On Request Only					
125 Rte 4 @ Scammel Bridge (West Side)	9:53 AM	11:40 AM	2:10 PM	4:10 PM	5:40 PM	9:06 PM
126 Rte 4 @ Emery Farm	9:54 AM	11:41 AM	2:12 PM	4:12 PM	5:42 PM	9:07 PM
193 Rte 4 @ Morgan Way	9:55 AM	11:42 AM	2:12 PM	4:12 PM	5:42 PM	9:07 PM
127 Rte 4 @ Shearwater Street	9:55 AM	11:42 AM	2:13 PM	4:13 PM	5:43 PM	9:08 PM
120 Rte 4 @ 65 Piscataqua Rd	9:56 AM	11:43 AM	2:13 PM	4:13 PM	5:43 PM	9:08 PM
119 Rte 108 @ The Pines Inn (#47)	9:59 AM	11:46 AM	2:16 PM	4:16 PM	5:46 PM	9:11 PM
108 Rte 108 @ Young Drive	9:59 AM	11:46 AM	2:17 PM	4:17 PM	5:47 PM	9:12 PM
117 Madbury Road @ Woodman Rd	10:01 AM	11:48 AM	2:19 PM	4:19 PM	5:49 PM	9:14 PM
116 ARRIVE Garrison Ave @ Sawyer Hall	10:03 AM	11:50 AM	2:20 PM	4:20 PM	5:50 PM	9:15 PM
105 ARRIVE Holloway Commons Main Street	10:04 AM	11:51 AM	2:21 PM	4:21 PM	5:51 PM	9:16 PM
1001 ARRIVE UNH McConnell Hall	10:06 AM	11:53 AM	2:23 PM	4:23 PM	5:53 PM	9:18 PM

These times are approximate. Please be at the bus stop 5 minutes before the scheduled time.

VEHICLE SPEED DATA



Accurate Counts
978-664-2565

S d 1007 001

D r R d
3 D r R d
S D r
Dr

10 31 2024	0-1 MP	1-20 MP	20-2 MP	2-30 MP	30-3 MP	3-40 MP	40-4 MP	4-0 MP	0-60 MP	60-6 MP	6-70 MP	70 MP	T
12 00 AM	0	0	7	11	13		0	0	0	0	0	0	36
1 00	0	0	1	9		1	0	0	0	0	0	0	16
2 00	0	0	1	6		1	0	0	0	0	0	0	13
3 00	1	0	3	7	4	2	1	0	0	0	0	0	1
4 00	2	1	6	12	7	2	0	0	0	0	0	0	30
5 00	0	0	11	71	39	12	1	0	0	0	0	0	134
6 00	9		2	97	71	1	1	0	0	0	0	0	223
7 00	4	4	1	16	73	1	0	0	0	0	0	0	31
8 00	4	36	116	229	114	14	0	0	0	0	0	0	7
9 00	2	43	104	203	124	1	0	0	0	0	0	0	17
10 00	29	21	71	16	113	2	6	0	0	0	0	0	44
11 00	2	26	0	192	107	16	0	1	0	3	0	0	40
12 00 PM	44	40	127	17	10	14	1	1	0	0	1	0	11
1 00	36	44	11	21	10	13	1	0	0	0	0	0	3
2 00	47	2	126	22	120	23	2	0	0	0	0	0	6
3 00	16	14	120	96	20	2	0	0	0	0	0	0	7
4 00	122	1	11	10	27	3	0	0	0	0	0	0	49
5 00	129	10	121	101	29	1	0	0	0	0	0	0	31
6 00	2	39	13	209	91	13	0	0	0	0	0	0	1
7 00	16	16	101	172		12	0	0	0	0	0	0	40
8 00		17	76	13	79	9	0	0	0	0	0	0	369
9 00	1	4	2	126	6	9	0	0	0	0	0	0	260
10 00	0	1	27	4	36	10	0	0	0	1	0	0	19
11 00	0	1	21	7	27	4	0	0	0	0	0	0	110
T	76	749	172	2966	1473	242	13	2	0	4	1	0	7961

P r 1 0 9
S d 1 2 30 33
M S d A r 2 3
10 MP P S d 21-30
r P 4691
P r P 90
r 2 MP 4701
P r 2 MP 91

Accurate Counts
978-664-2565

S d 1007 001

Dr	11 T	12 00 AM	12 01 MP	1 - 20 MP	2 - 30 MP	3 - 40 MP	4 - 0 MP	0 - 60 MP	6 - 70 MP	70 MP	T
		0	4	11	30	1	1	0	0	0	61
		0	4		16	1	3	1	0	0	47
		0	1	1	16	11	3	0	0	0	32
		0	1		12	4	1	0	0	0	23
		1	0	6	1	1	0	0	0	0	44
		0	0	17	7	33		0	2	0	11
		6	3	29	106	60	7	0	0	0	211
		46	40	170	16	44	3	0	0	0	46
		4	3	16	190		6	1	0	0	4
		21	24	9	202	107	14	1	0	0	4
		19	27	7	203	3	10	2	0	0	431
		29	36	101	19		16	0	0	0	46
		1	42	106	21	112	17	1	0	0	47
		3	4	10	211	102	17	0	0	0	36
		9	72	116	209	111	23	0	0	0	90
		190	1 0	133	7	21	0	0	0	0	1
		173	124	147	111	23	2	0	0	0	0
		130	124	1 1	147	41	6	0	0	0	629
		7	7	1 3	223	7	9	0	0	0	62
		24	4	166	237	4	6	0	0	0	6
		1	14	113	201		6	1	0	0	40
		4	1	0	169	62		0	0	0	33
		1	1	4	110	6	3	1	0	0	229
		3		20	73	31	3	1	0	0	136
		927	911	2090	3176	134	173	9	2	0	637

Pr 1 0 9
 S d 17 24 29 33
 M S d A r 24 6
 10 MP P S d 21-30
 r P 266
 P r P 61 0
 r 2 MP 4709
 P r 2 MP 4

Accurate Counts
978-664-2565

S d 1007 001

Dr	11 T	20 MP	20 MP	20 MP	30 MP	30 MP	40 MP	40 MP	40 MP	0 MP	60 MP	60 MP	70 MP	70 MP	T
12 00 AM	13	2	21	22	11	2	0	0	0	0	0	0	0	0	97
1 00	1	1		26	17	3	0	0	0	0	0	0	0	0	6
2 00	0	0	3	19	10	3	1	0	0	0	0	0	0	0	36
3 00	0	0	7	10		1	0	0	0	0	0	0	0	0	26
4 00	1	3	3	12	4	2	0	0	0	0	0	0	0	0	2
5 00	1	4		2	1	3	1	0	0	1	0	0	0	0	
6 00	2	2	16	32	2	7	1	0	0	0	0	0	0	0	
7 00		3	1	6	74	1	2	1	0	0	0	0	0	0	1 3
8 00		2	30	122	91	10	1	0	0	0	0	0	0	0	264
9 00	17	9	7	14	9	13	0	0	0	0	0	0	0	0	3 7
10 00	37	31	10	1	90	11	2	0	0	0	0	0	0	0	467
11 00		60	11	193	6	12	0	0	0	0	0	0	0	0	06
12 00 PM	2	6	129	1 1	67		0	0	0	0	0	0	0	0	499
1 00	6	6	179	244	7		1	0	0	0	0	0	0	0	634
2 00	41	4	1 7	274	91		0	0	0	0	0	0	0	0	622
3 00	46	2	170	243	133	14	1	0	0	0	0	0	0	0	6 9
4 00	121	140	1	192	49	3	0	0	0	0	0	0	0	0	693
5 00	26	0	147	24	12	16	0	0	0	0	0	0	0	0	609
6 00	1	14	123	207	9	12	1	0	0	0	0	0	0	0	473
7 00	7	7	4	207	9	7	0	0	0	0	0	0	0	0	401
8 00	11	7	74	1	6	6	0	0	0	0	0	0	0	0	324
9 00	1	7		116	9	1	0	0	0	0	0	0	0	0	2 6
10 00	0	3	23	101	43	4	2	0	0	0	0	0	0	0	176
11 00	0	1	26	62	34		1	0	0	0	0	0	0	0	129
T	64	629	1767	3062	144	1 2	14	1	0	1	0	0	0	0	766
			P r	1	0		9								
			S d	19	26	30	33								
M			S d A r	2											
10 MP			P S d	21-30											
			r P	4617											
			P r	P	630										
			r 2 MP	470											
			P r	2 MP	614										
r dT	2277	22 9	2	9204	4266	97	36		0	6	1	0	0	0	24263
S			P r	1	0		9								
			S d	1	2	30	33								
M			S d A r	2 2											
10 MP			P S d	21-30											
			r P	1469											
			P r	P	610										
			r 2 MP	1411											
			P r	2 MP	2										

Accurate Counts
978-664-2565

S d 1007 001

Dr	10 T	31 T	2024 T	0-1 MP	1-20 MP	20-2 MP	2-30 MP	30-3 MP	3-40 MP	40-4 MP	4-0 MP	0-60 MP	60-6 MP	6-70 MP	70 MP	T
12 00 AM				0	0	2	9	1	4	0	0	0	0	0	0	30
1 00				0	0	2	3	7	2	0	0	0	0	0	0	14
2 00				0	0	3	3	3	3	0	0	0	0	0	0	12
3 00				1	0	2			1	0	0	0	0	0	0	22
4 00				2	0	4	12	1	12	0	0	0	0	0	1	46
5 00				1	1	11	27	40	20	2	1	0	0	0	0	103
6 00				4	2	1	71	167	2	0	1	0	0	0	1	313
7 00				19	20	1	200	276	47	3	1	1	0	1	0	619
8 00				7	6	60	17	262	62	3	0	1	1	1	0	61
9 00				2	7	30	140	199	62		0	0	0	1	1	447
10 00				7	7	23	10	137	43	1	1	0	0	1	0	32
11 00						3	110	179	3	4	1	0	0	1	0	37
12 00 PM					23	3	116	13	33	1	0	1	0	0	0	349
1 00						39	136	17	3	3	0	1	0	0	0	411
2 00				3	9		17	234	27	3	0	0	0	0	0	1
3 00				11	26	4	12	93	23	2	0	1	0	1	0	369
4 00				76	31	0	2	3		2	0	0	0	1	0	270
5 00				0		72	17	101	11	1	0	1	0	1	1	33
6 00				3	11	21	177	16	23	2	0	0	0	1	0	406
7 00				2	2	17	127	169	23	6	0	0	0	0	0	347
8 00				0	2	23	3	129	2	3	0	0	0	0	2	270
9 00				1	1	17	3	10	24	2	0	0	0	0	2	23
10 00				0	1		42	6	1	1	0	0	0	0	4	124
11 00				1	4	6	40	2	16	0	0	0	1	0	0	120
T				1	177	662	2170	271	613	4	6	2	7	11		6642
						Pr	1	0	9							
						S d	24	29	33	3						
						M S d A r	30 1									
						10 MP P S d	26-3									
						r P	49 1									
						Pr P	7 0									
						r 2 MP	64									
						Pr 2 MP	0									

Accurate Counts
978-664-2565

S d 1007 001

Dr	11 2 2024	0-1 MP	1 - 20 MP	20- 2 MP	2 - 30 MP	30- 3 MP	3 - 40 MP	40- 4 MP	4 - 0 MP	0- MP	- 60 MP	60- 6 MP	6 - 70 MP	70 MP	T
12 00 AM		4	16	39	24	16	3	1	0	0	0	0	0	0	103
1 00		1	2	4	12	29	6	1	0	0	0	0	0	0	
2 00		0	1	2	13	19	10	2	0	0	0	0	0	0	47
3 00		2	2	4	6	1		2	0	0	0	0	0	0	39
4 00		2	0		9	1	10	0	0	0	0	0	0	0	41
00		0	6	3	1	17		0	0	0	0	0	0	0	2
6 00		1	2	21	42	90	20	3	0	0	0	0	0	1	1 0
7 00		4	2	17	63	104	4	3	0	0	0	0	0	0	23
00		1	3	24	93	1 0	62	6	2	0	0	0	0	0	371
9 00		4	6	32	1 4	262	44	1	0	0	0	0	0	0	33
10 00		2	9	4	230	272	43	1	0	0	0	0	0	0	611
11 00		2	11	6	2 7	2 7	41	0	0	1	0	0	0	0	634
12 00 PM		2	16		2 9	272	40	2	0	0	0	0	0	0	679
1 00		2	7	97	293	201	30	1	2	0	0	0	0	0	633
2 00			6	40	23	2 0	7	7	1	0	0	0	0	1	60
3 00		4	12	4	211	224	49	2	0	0	0	0	0	0	6
4 00		4		6	192	1 0	40	1	0	0	0	0	0	0	47
00			3	2	190	216		2	0	0	0	0	1	1	01
6 00		0	0	30	166	214	42	2	0	1	0	0	0	0	4
7 00		1	7	42	17	193	31	0	0	0	0	0	0	0	4 2
00		3	3	12	97	139	3	0	0	0	1	0	3	0	293
9 00		2	0	20	69	116	31	2	0	0	0	0	0	0	240
10 00		0	2	6	3	60	2	3	1	0	0	2	1	1	142
11 00		1	1		21	6	23	1	0	0	0	0	0	0	10
T			122	74	2903	3397	761	43	6	2	1	2		4	049
				P r	1	0		9							
				S d	2	29	33	3							
				M S d A r	30										
				10 MP P S d	26-3										
				r P	612										
				P r P	79 0										
				r 2 MP	7124										
				P r 2 MP											
r d T		336	494	2223	7 11	91 4	20	131	23		9	12	22	13	22294
S				P r	1	0		9							
				S d	24	29	33	3							
				M S d A r	30 2										
				10 MP P S d	26-3										
				r P	16										
				P r P	76 0										
				r 2 MP	19241										
				P r 2 MP	6 3										

GROWTH RATE DATA



Station 02133021
 Durham - US 4 East of NH 108
 Group 4
 Region E
 FC 14

AADT Annual Change

2009	16830	
2010	16682	-0.88%
2011	16000	-4.09%
2012	16152	0.95%
2013	15989	-1.01%
2014	15969	-0.13%
2015	16208	1.50%
2016	16591	2.36%
2017	16450	-0.85%
2018	16021	-2.61%
2019	15596	-2.65%

CAGR	-0.76%
Exp	-0.40%
Avg	-0.58%

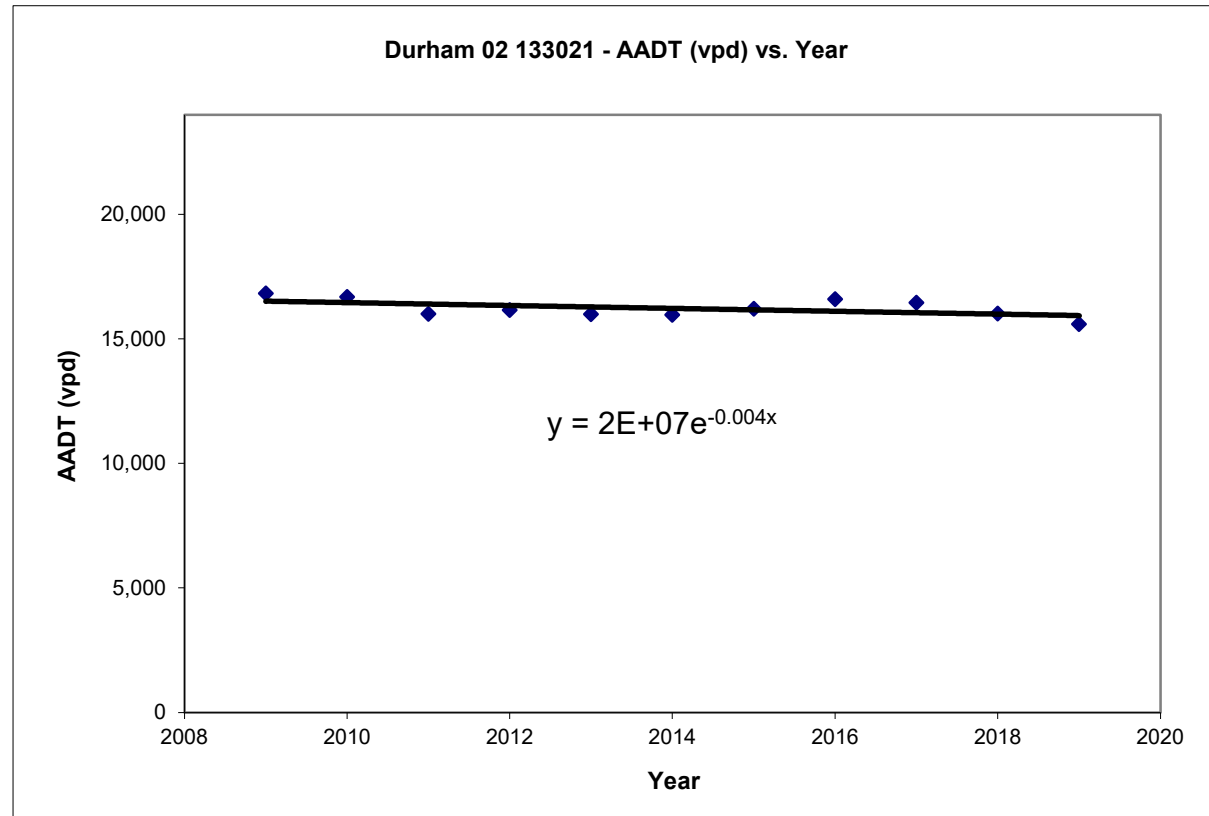

TRIP GENERATION DATA



Existing Dunkins Square Footage	1,100 sf	Start Time	Pedestrian		Vehicle		Total				
			In	Out	In	Out	In	Out			
	1.1 ksf	7:00 AM	1	0	14	13	15	13			
Proposed Dunkins Square Footage	1,500 sf	7:15 AM	0	1	16	24	16	25			
		7:30 AM	0	0	16	19	16	19			
	1.5 ksf	7:45 AM	0	0	18	15	18	15	137	In	Out
		8:00 AM	1	1	10	13	11	14	134	61	73
		8:15 AM	0	0	8	10	8	10	111		
		8:30 AM	1	1	15	17	16	18	110		
		8:45 AM	1	1	11	12	12	13	102		
		Total	4	4	108	123	112	127			

Start Time	Pedestrian		Vehicle		Total				
	In	Out	In	Out	In	Out			
3:00 PM	0	0	2	2	2	2			
3:15 PM	0	0	9	3	9	3			
3:30 PM	0	0	4	11	4	11			
3:45 PM	0	0	8	8	8	8	47	In	Out
4:00 PM	0	0	5	7	5	7	55	26	29
4:15 PM	0	0	2	2	2	2	47		
4:30 PM	2	2	5	1	7	3	42		
4:45 PM	0	0	1	3	1	3	30		
5:00 PM	0	0	5	5	5	5	28		
5:15 PM	0	0	3	3	3	3	30		
5:30 PM	0	0	1	1	1	1	22		
5:45 PM	0	0	2	1	2	1	21		
Total	2	2	47	47	49	49			

			Total	Existing	New	Trip Rate	Total	Proposed	New	Total	Net	New
			Trips	Pass-By	Trips		Trips	Trips	Trips	Trips	Pass-By	Trips
Weekday Daily			636	508	128	-	868	694	174	232	186	46
Weekday Morning Peak Hour												
In			61	54	7	55.45	83	73	10	22	19	3
Out			73	54	19	66.36	100	73	27	27	19	8
Total			134	108	26	121.81	183	146	37	49	38	11
Weekday Evening Peak Hour												
In			26	22	4	23.64	35	30	5	9	8	1
Out			29	22	7	26.36	40	30	10	11	8	3
Total			55	44	11	50.00	75	60	15	20	16	4
Saturday Daily			694	556	138	-	946	756	190	252	200	52
Pass By Percentage	LUC 938	Used										
Daily	-	0.80										
Saturday Midday Peak Hour												
In			40	32	8	36.36	55	44	11	15	12	3
Out			41	32	9	37.27	56	44	12	15	12	3
Total			81	64	17	73.63	111	88	23	30	24	6
SAT Daily			-	-	-	-	-	-	-	-	-	-
Sat Mid			-	-	-	-	-	-	-	-	-	-

No Pass-By for LUC 936

Institute of Transportation Engineers (ITE)
Trip Generation , 11th Edition
Land Use Code (LUC) 936 - Coffee/Donut Shop without Drive-Through Window

Average Vehicle Trips Ends vs: 1000 Square Feet Gross Floor Area
 Independent Variable (X): 1.100

AVERAGE WEEKDAY DAILY

LUC 937 Daily = 533.57 LUC 936 Daily = X
 LUC 937 AM Peak = 85.88 LUC 936 AM Peak = 93.08

X = 578.3

T = 578.3 * (X)
 T = 578.3 * 1.100
 T = 636.13
 T = 636 vehicle trips
 with 50% (318 vpd) entering and 50% (318 vpd) exiting.

WEEKDAY MORNING PEAK HOUR OF ADJACENT STREET TRAFFIC

T = 93.08 * (X)
 T = 93.08 * 1.100
 T = 102.39
 T = 102 vehicle trips
 with 51% (52 vph) entering and 49% (50 vph) exiting.

WEEKDAY EVENING PEAK HOUR OF ADJACENT STREET TRAFFIC

T = 32.29 * (X)
 T = 32.29 * 1.100
 T = 35.52
 T = 36 vehicle trips
 with 50% (18 vph) entering and 50% (18 vph) exiting.

Saturday DAILY

LUC 934 Saturday Daily = 616.1 LUC 936 Daily = X
 LUC 934 SAT Mid Peak = 55.25 LUC 936 AM Peak = 56.50

X = 630.04

T = 630.04 * (X)
 T = 630.04 * 0.000
 T = 693.04
 T = 694 vehicle trips
 with 50% (347 vpd) entering and 50% (347 vpd) exiting.

SATURDAY MIDDAY PEAK HOUR OF GENERATOR

T = 56.50 * (X)
 T = 56.50 * 1.100
 T = 62.15
 T = 62 vehicle trips
 with 49% (30 vph) entering and 51% (32 vph) exiting.

Institute of Transportation Engineers (ITE)

Trip Generation , 11th Edition

Land Use Code (LUC) 936 - Coffee/Donut Shop without Drive-Through Window

Average Vehicle Trips Ends vs: 1000 Square Feet Gross Floor Area
Independent Variable (X): 1.500

AVERAGE WEEKDAY DAILY

LUC 937 Daily = 533.57 LUC 936 Daily = X
LUC 937 AM Peak = 85.88 LUC 936 AM Peak = 93.08

X = 578.3

T = 578.3 * (X)
T = 578.3 * 1.500
T = 867.45
T = 868 vehicle trips
with 50% (434 vpd) entering and 50% (434 vpd) exiting.

WEEKDAY MORNING PEAK HOUR OF ADJACENT STREET TRAFFIC

T = 93.08 * (X)
T = 93.08 * 1.500
T = 139.62
T = 140 vehicle trips
with 51% (71 vph) entering and 49% (69 vph) exiting.

WEEKDAY EVENING PEAK HOUR OF ADJACENT STREET TRAFFIC

T = 32.29 * (X)
T = 32.29 * 1.500
T = 48.44
T = 48 vehicle trips
with 50% (24 vph) entering and 50% (24 vph) exiting.

Saturday DAILY

LUC 934 Saturday Daily = 616.1 LUC 936 Daily = X
LUC 934 SAT Mid Peak = 55.25 LUC 936 AM Peak = 56.50

X = 630.04

T = 630.04 * (X)
T = 630.04 * 1.500
T = 945.06
T = 946 vehicle trips
with 50% (473 vpd) entering and 50% (473 vpd) exiting.

SATURDAY MIDDAY PEAK HOUR OF GENERATOR

T = 56.50 * (X)
T = 56.50 * 1.500
T = 84.75
T = 85 vehicle trips
with 49% (42 vph) entering and 51% (43 vph) exiting.

TURN LANE WARRANT ANALYSIS



Figure 2 - 5. Guideline for determining the need for a major-road left-turn bay at a two-way stop-controlled intersection.

2-lane roadway (English)

INPUT

Variable	Value
85 th percentile speed, mph:	33
Percent of left-turns in advancing volume (V_A), %:	7%
Advancing volume (V_A), veh/h:	688
Opposing volume (V_O), veh/h:	664

OUTPUT

Variable	Value
Limiting advancing volume (V_A), veh/h:	355
Guidance for determining the need for a major-road left-turn bay:	
Left-turn treatment warranted.	

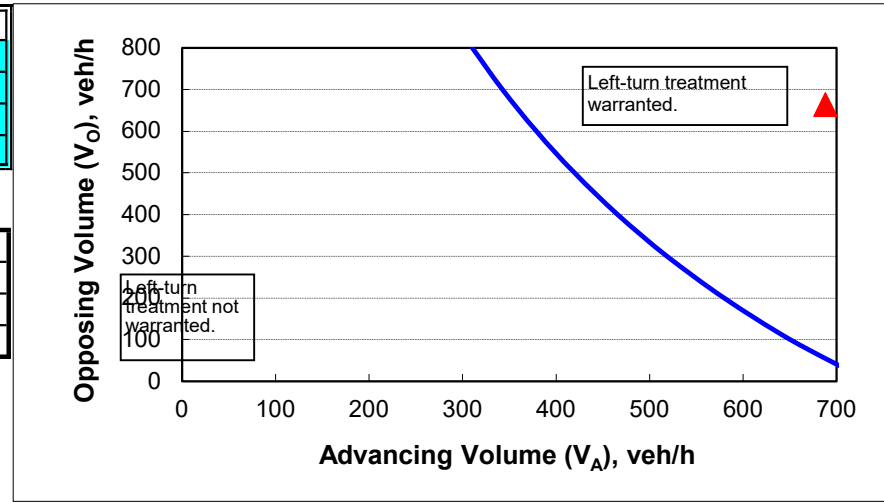

CALIBRATION CONSTANTS

Variable	Value
Average time for making left-turn, s:	3.0
Critical headway, s:	5.0
Average time for left-turn vehicle to clear the advancing lane, s:	1.9

Figure 2 - 5. Guideline for determining the need for a major-road left-turn bay at a two-way stop-controlled intersection.

2-lane roadway (English)

INPUT

Variable	Value
85 th percentile speed, mph:	33
Percent of left-turns in advancing volume (V_A), %:	3%
Advancing volume (V_A), veh/h:	768
Opposing volume (V_O), veh/h:	747

OUTPUT

Variable	Value
Limiting advancing volume (V_A), veh/h:	528
Guidance for determining the need for a major-road left-turn bay:	
Left-turn treatment warranted.	

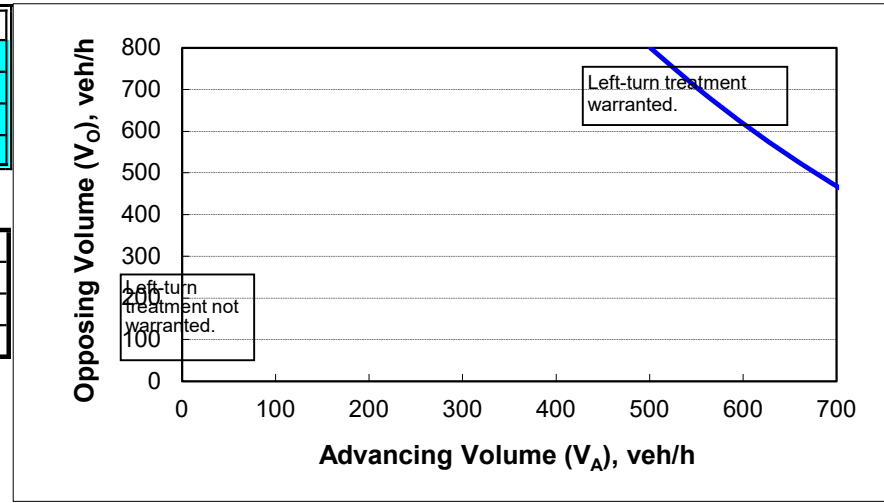

CALIBRATION CONSTANTS

Variable	Value
Average time for making left-turn, s:	3.0
Critical headway, s:	5.0
Average time for left-turn vehicle to clear the advancing lane, s:	1.9

Figure 2 - 5. Guideline for determining the need for a major-road left-turn bay at a two-way stop-controlled intersection.

2-lane roadway (English)

INPUT

Variable	Value
85 th percentile speed, mph:	33
Percent of left-turns in advancing volume (V_A), %:	4%
Advancing volume (V_A), veh/h:	773
Opposing volume (V_O), veh/h:	763

OUTPUT

Variable	Value
Limiting advancing volume (V_A), veh/h:	407
Guidance for determining the need for a major-road left-turn bay:	
Left-turn treatment warranted.	

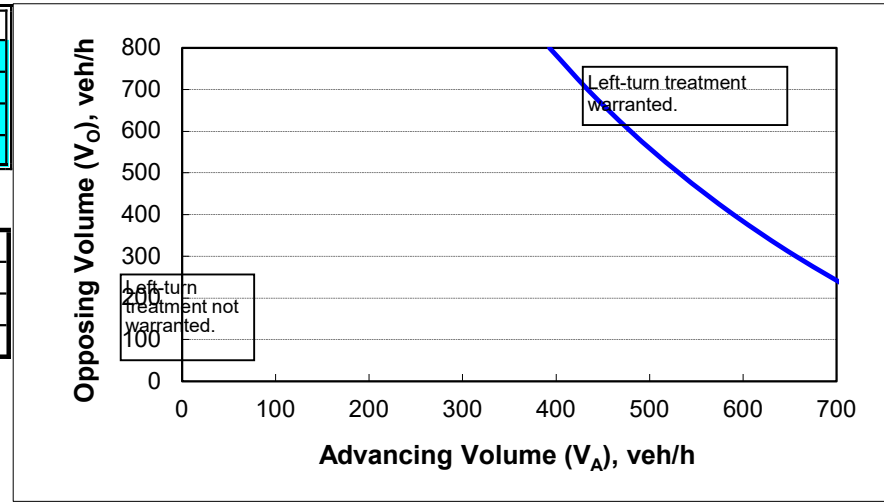

CALIBRATION CONSTANTS

Variable	Value
Average time for making left-turn, s:	3.0
Critical headway, s:	5.0
Average time for left-turn vehicle to clear the advancing lane, s:	1.9

Figure 2 - 5. Guideline for determining the need for a major-road left-turn bay at a two-way stop-controlled intersection.

2-lane roadway (English)

INPUT

Variable	Value
85 th percentile speed, mph:	33
Percent of left-turns in advancing volume (V_A), %:	6%
Advancing volume (V_A), veh/h:	760
Opposing volume (V_O), veh/h:	733

OUTPUT

Variable	Value
Limiting advancing volume (V_A), veh/h:	348
Guidance for determining the need for a major-road left-turn bay:	
Left-turn treatment warranted.	

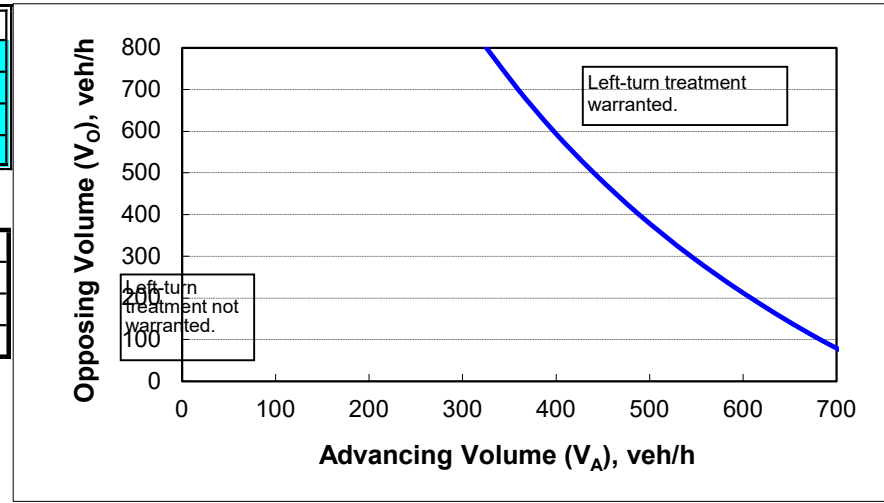

CALIBRATION CONSTANTS

Variable	Value
Average time for making left-turn, s:	3.0
Critical headway, s:	5.0
Average time for left-turn vehicle to clear the advancing lane, s:	1.9

Figure 2 - 5. Guideline for determining the need for a major-road left-turn bay at a two-way stop-controlled intersection.

2-lane roadway (English)

INPUT

Variable	Value
85 th percentile speed, mph:	33
Percent of left-turns in advancing volume (V_A), %:	2%
Advancing volume (V_A), veh/h:	849
Opposing volume (V_O), veh/h:	825

OUTPUT

Variable	Value
Limiting advancing volume (V_A), veh/h:	508
Guidance for determining the need for a major-road left-turn bay:	
Left-turn treatment warranted.	

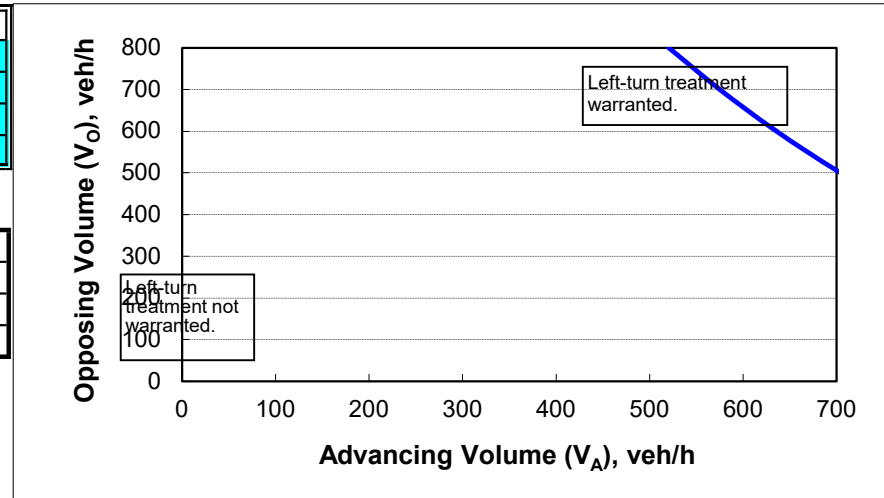

CALIBRATION CONSTANTS

Variable	Value
Average time for making left-turn, s:	3.0
Critical headway, s:	5.0
Average time for left-turn vehicle to clear the advancing lane, s:	1.9

Figure 2 - 5. Guideline for determining the need for a major-road left-turn bay at a two-way stop-controlled intersection.

2-lane roadway (English)

INPUT

Variable	Value
85 th percentile speed, mph:	33
Percent of left-turns in advancing volume (V_A), %:	4%
Advancing volume (V_A), veh/h:	854
Opposing volume (V_O), veh/h:	845

OUTPUT

Variable	Value
Limiting advancing volume (V_A), veh/h:	394
Guidance for determining the need for a major-road left-turn bay:	
Left-turn treatment warranted.	

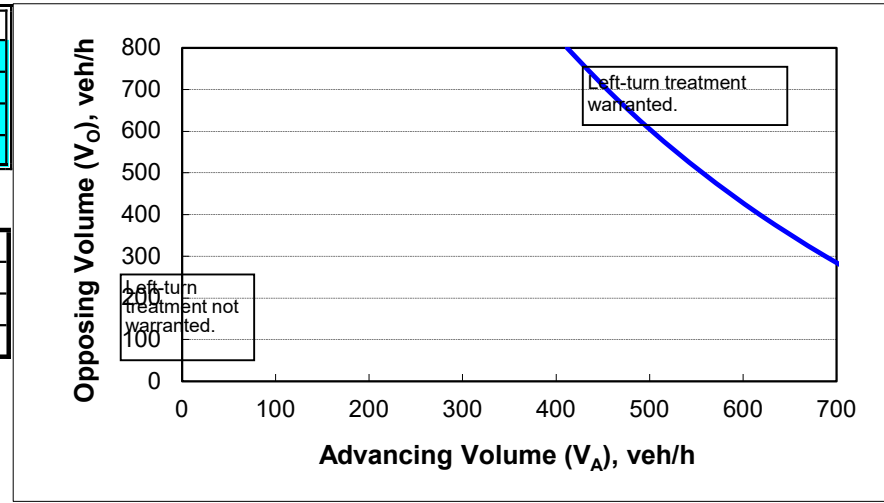

CALIBRATION CONSTANTS

Variable	Value
Average time for making left-turn, s:	3.0
Critical headway, s:	5.0
Average time for left-turn vehicle to clear the advancing lane, s:	1.9

Figure 2 - 6. Guideline for determining the need for a major-road right-turn bay at a two-way stop-controlled intersection.

INPUT

Roadway geometry:	2-lane roadway
Variable	Value
Major-road speed, mph:	30
Major-road volume (one direction), veh/h:	664
Right-turn volume, veh/h:	34

OUTPUT

Variable	Value
Limiting right-turn volume, veh/h:	141
Guidance for determining the need for a major-road right-turn bay for a 2-lane roadway:	
Do NOT add right-turn bay.	

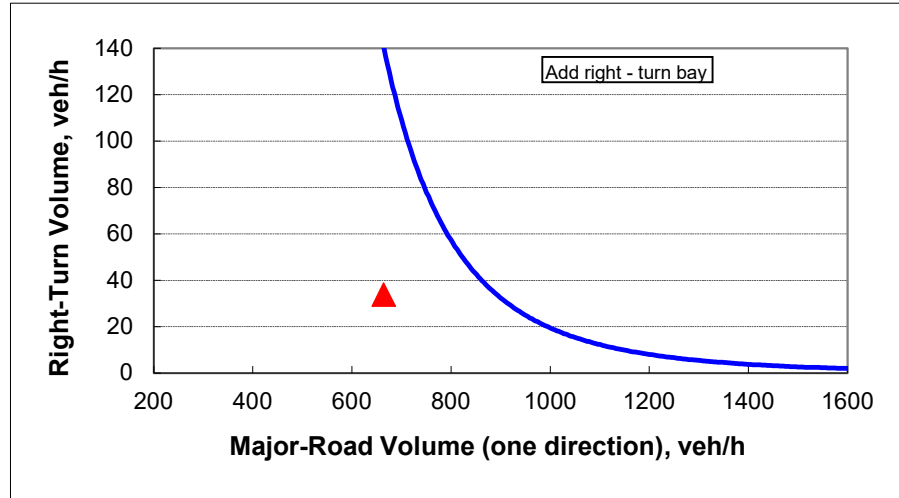

Figure 2 - 6. Guideline for determining the need for a major-road right-turn bay at a two-way stop-controlled intersection.

INPUT

Roadway geometry:	2-lane roadway
Variable	Value
Major-road speed, mph:	30
Major-road volume (one direction), veh/h:	747
Right-turn volume, veh/h:	15

OUTPUT

Variable	Value
Limiting right-turn volume, veh/h:	80
Guidance for determining the need for a major-road right-turn bay for a 2-lane roadway:	
Do NOT add right-turn bay.	

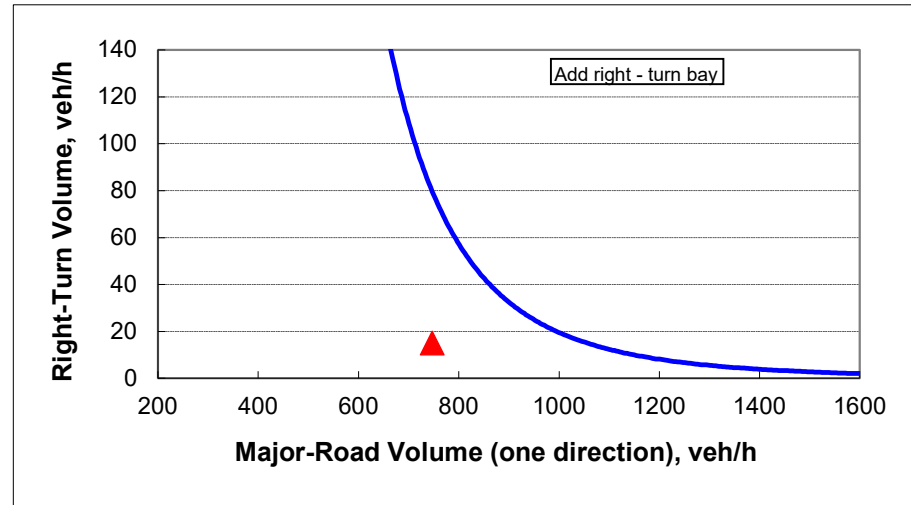

Figure 2 - 6. Guideline for determining the need for a major-road right-turn bay at a two-way stop-controlled intersection.

INPUT

Roadway geometry:	2-lane roadway
Variable	Value
Major-road speed, mph:	30
Major-road volume (one direction), veh/h:	763
Right-turn volume, veh/h:	22

OUTPUT

Variable	Value
Limiting right-turn volume, veh/h:	72
Guidance for determining the need for a major-road right-turn bay for a 2-lane roadway:	
Do NOT add right-turn bay.	

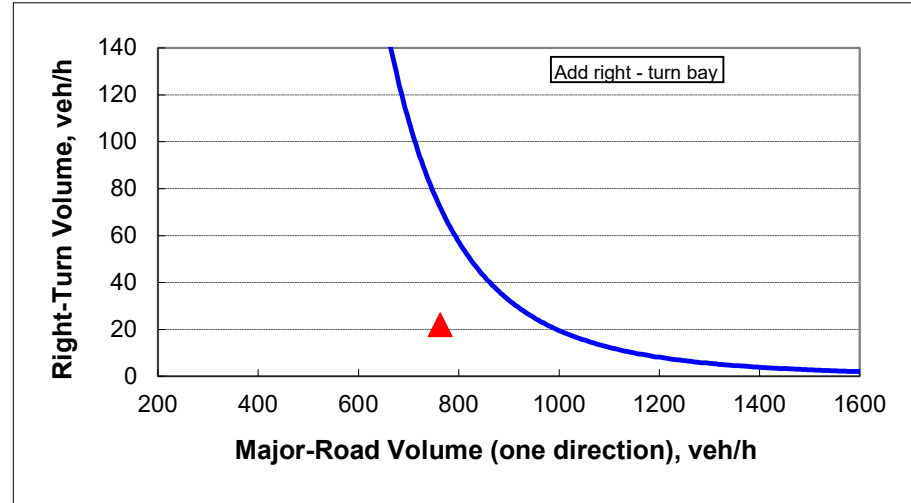

Figure 2 - 6. Guideline for determining the need for a major-road right-turn bay at a two-way stop-controlled intersection.

INPUT

Roadway geometry:	2-lane roadway
Variable	Value
Major-road speed, mph:	30
Major-road volume (one direction), veh/h:	733
Right-turn volume, veh/h:	34

OUTPUT

Variable	Value
Limiting right-turn volume, veh/h:	87
Guidance for determining the need for a major-road right-turn bay for a 2-lane roadway:	
Do NOT add right-turn bay.	

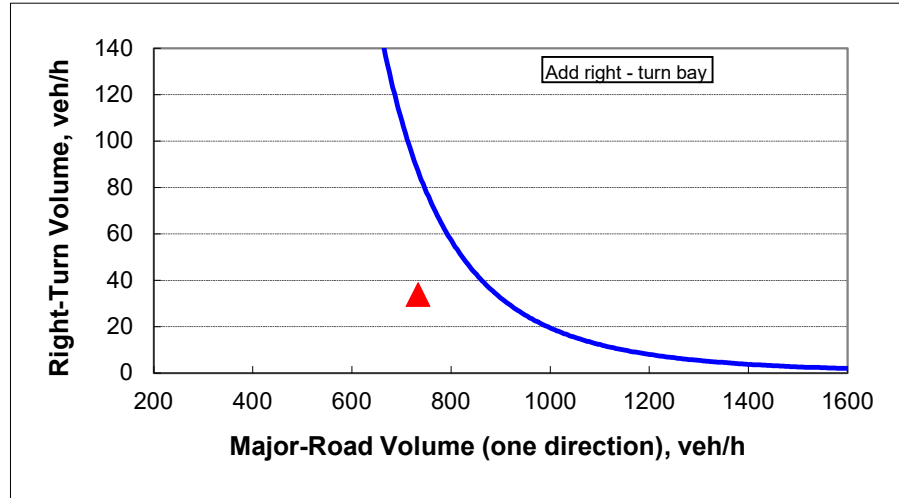

Figure 2 - 6. Guideline for determining the need for a major-road right-turn bay at a two-way stop-controlled intersection.

INPUT

Roadway geometry:	2-lane roadway
Variable	Value
Major-road speed, mph:	30
Major-road volume (one direction), veh/h:	825
Right-turn volume, veh/h:	15

OUTPUT

Variable	Value
Limiting right-turn volume, veh/h:	49
Guidance for determining the need for a major-road right-turn bay for a 2-lane roadway:	
Do NOT add right-turn bay.	

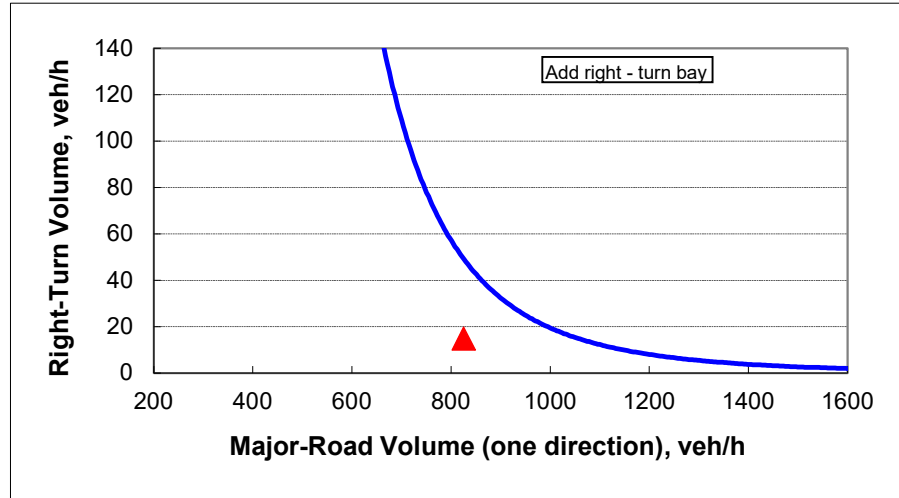

2025 Opening Year Build AM
Northbound Right-turn

Figure 2 - 6. Guideline for determining the need for a major-road right-turn bay at a two-way stop-controlled inter

INPUT

Roadway geometry:	2-lane roadway
Variable	Value
Major-road speed, mph:	30
Major-road volume (one direction), veh/h:	845
Right-turn volume, veh/h:	22

OUTPUT

Variable	Value
Limiting right-turn volume, veh/h:	44
Guidance for determining the need for a major-road right-turn bay for a 2-lane roadway:	
Do NOT add right-turn bay.	

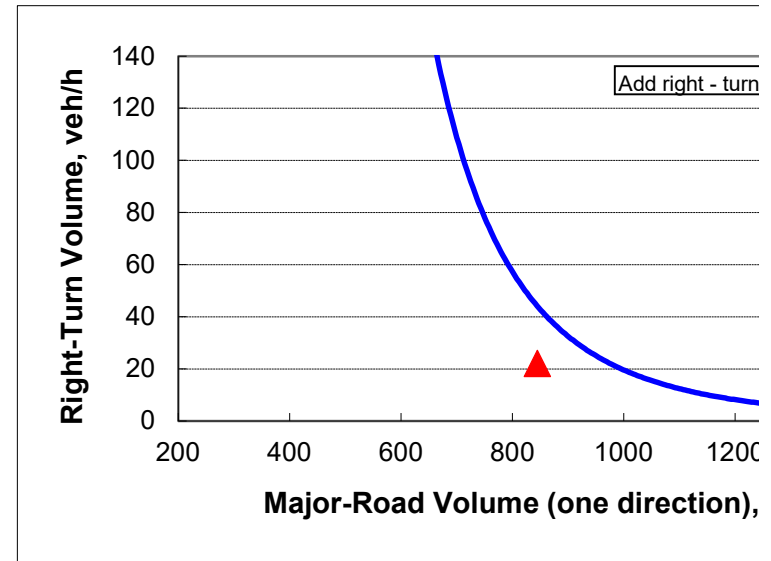

2025 Opening Year Build AM
Northbound Right-turn

section.

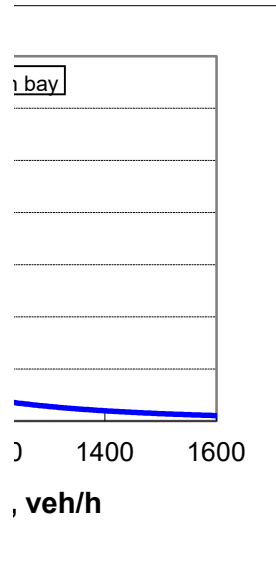

CAPACITY ANALYSIS

2024 Existing Weekday Morning Peak Hour
2024 Existing Weekday Evening Peak Hour
2024 Existing Saturday Midday Peak Hour
2025 Opening Year No-Build Weekday Morning Peak Hour
2025 Opening Year No-Build Weekday Evening Peak Hour
2025 Opening Year No-Build Saturday Midday Peak Hour
2025 Opening Year Build Weekday Morning Peak Hour
2025 Opening Year Build Weekday Evening Peak Hour
2025 Opening Year Build Saturday Midday Peak Hour
2025 Opening Year Build Mitigated Weekday Morning Peak Hour
2025 Opening Year Build Mitigated Weekday Evening Peak Hour
2025 Opening Year Build Mitigated Saturday Midday Peak Hour
2035 Design Year No-Build Weekday Morning Peak Hour
2035 Design Year No-Build Weekday Evening Peak Hour
2035 Design Year No-Build Saturday Midday Peak Hour
2035 Design Year Build Weekday Morning Peak Hour
2035 Design Year Build Weekday Evening Peak Hour
2035 Design Year Build Saturday Midday Peak Hour
2035 Design Year Build Mitigated Weekday Morning Peak Hour
2035 Design Year Build Mitigated Weekday Evening Peak Hour
2035 Design Year Build Mitigated Saturday Midday Peak Hour



2024 Existing Weekday Morning Peak Hour



3: Main Street /Dover Road & Newmarket Road/Holiday Inn Express Driveway

01/07/2025

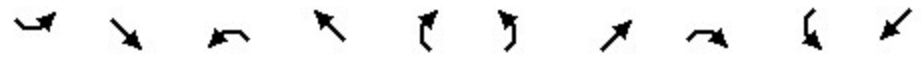

Lane Group	SEL	SET	NWL	NWT	NWR	NEL	NET	NER	SWL	SWT	Ø9
Lane Configurations		↔		↕	↗	↘	↖	↗	↘	↖	↗
Traffic Volume (vph)	3	0	154	0	483	2	174	95	395	258	
Future Volume (vph)	3	0	154	0	483	2	174	95	395	258	
Turn Type	Perm	NA	Perm	NA	Perm	Prot	NA	Perm	Prot	NA	
Protected Phases		4		8		5	2		1	6	9
Permitted Phases	4		8		8			2			
Detector Phase	4	4	8	8	8	5	2	2	1	6	
Switch Phase											
Minimum Initial (s)	5.0	5.0	5.0	5.0	5.0	5.0	5.0	5.0	5.0	5.0	5.0
Minimum Split (s)	11.0	11.0	11.0	11.0	11.0	16.0	16.0	16.0	16.0	16.0	20.0
Total Split (s)	36.0	36.0	36.0	36.0	36.0	19.0	36.0	36.0	36.0	53.0	19.0
Total Split (%)	28.3%	28.3%	28.3%	28.3%	28.3%	15.0%	28.3%	28.3%	28.3%	41.7%	15%
Yellow Time (s)	4.0	4.0	4.0	4.0	4.0	4.0	4.0	4.0	4.0	4.0	2.0
All-Red Time (s)	2.0	2.0	2.0	2.0	2.0	2.0	2.0	2.0	2.0	2.0	0.0
Lost Time Adjust (s)		-2.0		-2.0	-2.0	-2.0	-2.0	-2.0	-2.0	-2.0	-2.0
Total Lost Time (s)		4.0		4.0	4.0	4.0	4.0	4.0	4.0	4.0	
Lead/Lag						Lead	Lag	Lag	Lead	Lag	
Lead-Lag Optimize?						Yes	Yes	Yes	Yes	Yes	
Recall Mode	Min	Min	Min	Min	Min	None	Min	Min	Max	Min	None

Intersection Summary

Cycle Length: 127
 Actuated Cycle Length: 92.2
 Natural Cycle: 80
 Control Type: Semi Act-Uncoord

Splits and Phases: 3: Main Street /Dover Road & Newmarket Road/Holiday Inn Express Driveway

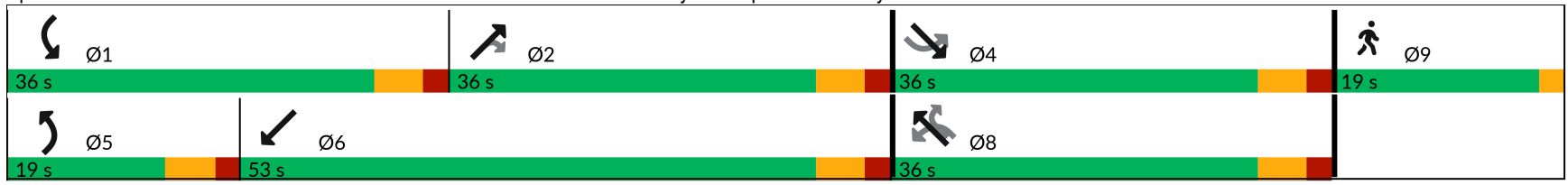

3: Main Street /Dover Road & Newmarket Road/Holiday Inn Express Driveway

01/07/2025























Lane Group	SET	NWT	NWR	NEL	NET	NER	SWL	SWT
Lane Group Flow (vph)	12	197	619	2	198	108	454	297
v/c Ratio	0.02	0.54	0.71	0.01	0.49	0.25	0.72	0.29
Control Delay (s/veh)	0.0	37.0	7.8	46.0	38.7	3.8	37.2	14.4
Queue Delay	0.0	0.0	0.0	0.0	0.0	0.0	0.0	0.0
Total Delay (s/veh)	0.0	37.0	7.8	46.0	38.7	3.8	37.2	14.4
Queue Length 50th (ft)	0	90	0	1	97	0	211	68
Queue Length 95th (ft)	0	183	22	10	207	19	#554	238
Internal Link Dist (ft)	1	409			368			56
Turn Bay Length (ft)			155	35		300		
Base Capacity (vph)	633	478	958	287	711	660	627	1040
Starvation Cap Reductn	0	0	0	0	0	0	0	0
Spillback Cap Reductn	0	0	0	0	0	0	0	0
Storage Cap Reductn	0	0	0	0	0	0	0	0
Reduced v/c Ratio	0.02	0.41	0.65	0.01	0.28	0.16	0.72	0.29

Intersection Summary
 # 95th percentile volume exceeds capacity, queue may be longer.
 Queue shown is maximum after two cycles.

3: Main Street /Dover Road & Newmarket Road/Holiday Inn Express Driveway

01/07/2025

												
Movement	SEL	SET	SER	NWL	NWT	NWR	NEL	NET	NER	SWL	SWT	SWR
Lane Configurations												
Traffic Volume (vph)	3	0	3	154	0	483	2	174	95	395	258	0
Future Volume (vph)	3	0	3	154	0	483	2	174	95	395	258	0
Ideal Flow (vphpl)	1900	1900	1900	1900	1900	1900	1900	1900	1900	1900	1900	1900
Lane Width	12	11	12	12	11	12	11	14	12	12	11	12
Grade (%)		0%			4%			-6%			0%	
Total Lost time (s)		4.0			4.0	4.0	4.0	4.0	4.0	4.0	4.0	
Lane Util. Factor		1.00			1.00	1.00	1.00	1.00	1.00	1.00	1.00	
Frbp, ped/bikes		1.00			1.00	1.00	1.00	1.00	1.00	1.00	1.00	
Flpb, ped/bikes		1.00			1.00	1.00	1.00	1.00	1.00	1.00	1.00	
Frt		0.93			1.00	0.85	1.00	1.00	0.85	1.00	1.00	
Flt Protected		0.98			0.95	1.00	0.95	1.00	1.00	0.95	1.00	
Satd. Flow (prot)		1671			1693	1567	1712	1988	1584	1752	1783	
Flt Permitted		0.88			0.75	1.00	0.95	1.00	1.00	0.95	1.00	
Satd. Flow (perm)		1509			1336	1567	1712	1988	1584	1752	1783	
Peak-hour factor, PHF	0.50	0.50	0.50	0.78	0.78	0.78	0.88	0.88	0.88	0.87	0.87	0.87
Adj. Flow (vph)	6	0	6	197	0	619	2	198	108	454	297	0
RTOR Reduction (vph)	0	9	0	0	0	462	0	0	82	0	0	0
Lane Group Flow (vph)	0	3	0	0	197	157	2	198	26	454	297	0
Confl. Bikes (#/hr)												2
Heavy Vehicles (%)	0%	0%	0%	1%	1%	1%	5%	5%	5%	3%	3%	3%
Turn Type	Perm	NA		Perm	NA	Perm	Prot	NA	Perm	Prot	NA	
Protected Phases		4			8		5	2		1	6	
Permitted Phases	4			8		8			2			
Actuated Green, G (s)		23.0			23.0	23.0	1.2	22.1	22.1	30.9	51.8	
Effective Green, g (s)		25.0			25.0	25.0	3.2	24.1	24.1	32.9	53.8	
Actuated g/C Ratio		0.25			0.25	0.25	0.03	0.24	0.24	0.33	0.55	
Clearance Time (s)		6.0			6.0	6.0	6.0	6.0	6.0	6.0	6.0	
Vehicle Extension (s)		5.0			5.0	5.0	5.0	5.0	5.0	5.0	5.0	
Lane Grp Cap (vph)		382			338	396	55	485	386	584	971	
v/s Ratio Prot							0.00	c0.10		c0.26	0.17	
v/s Ratio Perm		0.00			c0.15	0.10			0.02			
v/c Ratio		0.01			0.58	0.40	0.04	0.41	0.07	0.78	0.31	

3: Main Street /Dover Road & Newmarket Road/Holiday Inn Express Driveway

01/07/2025



Movement	SEL	SET	SER	NWL	NWT	NWR	NEL	NET	NER	SWL	SWT	SWR
Uniform Delay, d1		27.6			32.3	30.6	46.3	31.3	28.7	29.6	12.3	
Progression Factor		1.00			1.00	1.00	1.00	1.00	1.00	1.00	1.00	
Incremental Delay, d2		0.0			3.9	1.4	0.6	1.2	0.2	9.8	0.4	
Delay (s)		27.6			36.2	31.9	46.8	32.5	28.8	39.4	12.6	
Level of Service		C			D	C	D	C	C	D	B	
Approach Delay (s/veh)		27.6			33.0			31.3			28.8	
Approach LOS		C			C			C			C	

Intersection Summary			
HCM 2000 Control Delay (s/veh)	31.0	HCM 2000 Level of Service	C
HCM 2000 Volume to Capacity ratio	0.59		
Actuated Cycle Length (s)	98.7	Sum of lost time (s)	14.0
Intersection Capacity Utilization	56.1%	ICU Level of Service	B
Analysis Period (min)	15		



















c Critical Lane Group

5: Dover Road & Irving Gas Station Driveway

01/07/2025



Movement	NWL	NWR	NET	NER	SWL	SWT
Lane Configurations			↔			↔↔
Traffic Volume (veh/h)	0	0	614	46	5	653
Future Volume (Veh/h)	0	0	614	46	5	653
Sign Control	Stop		Free		Free	
Grade	0%		-3%		3%	
Peak Hour Factor	0.92	0.92	0.88	0.88	0.87	0.87
Hourly flow rate (vph)	0	0	698	52	6	751
Pedestrians						
Lane Width (ft)						
Walking Speed (ft/s)						
Percent Blockage						
Right turn flare (veh)						
Median type	None			None		
Median storage (veh)						
Upstream signal (ft)	136					
pX, platoon unblocked	0.92	0.92			0.92	
vC, conflicting volume	1112	724			750	
vC1, stage 1 conf vol						
vC2, stage 2 conf vol						
vCu, unblocked vol	1077	654			683	
tC, single (s)	6.8	6.9			4.2	
tC, 2 stage (s)						
tF (s)	3.5	3.3			2.2	
p0 queue free %	100	100			99	
cM capacity (veh/h)	198	380			825	
Direction, Lane #	NE 1	SW 1	SW 2			
Volume Total	750	256	501			
Volume Left	0	6	0			
Volume Right	52	0	0			
cSH	1700	825	1700			
Volume to Capacity	0.44	0.01	0.29			
Queue Length 95th (ft)	0	1	0			
Control Delay (s/veh)	0.0	0.3	0.0			
Lane LOS	A					
Approach Delay (s/veh)	0.0	0.1				
Approach LOS						
Intersection Summary						
Average Delay			0.1			
Intersection Capacity Utilization			38.4%	ICU Level of Service		A
Analysis Period (min)			15			

												
Movement	SEL	SET	SER	NWL	NWT	NWR	NEL	NET	NER	SWL	SWT	SWR
Lane Configurations												
Traffic Volume (veh/h)	0	0	0	33	0	71	0	611	3	30	625	1
Future Volume (Veh/h)	0	0	0	33	0	71	0	611	3	30	625	1
Sign Control		Stop			Stop			Free			Free	
Grade		0%			0%			-3%			3%	
Peak Hour Factor	0.25	0.25	0.25	0.63	0.63	0.63	0.84	0.84	0.84	0.85	0.85	0.85
Hourly flow rate (vph)	0	0	0	52	0	113	0	727	4	35	735	1
Pedestrians												
Lane Width (ft)												
Walking Speed (ft/s)												
Percent Blockage												
Right turn flare (veh)												
Median type												
								None			None	
Median storage veh												
Upstream signal (ft)												
								223				
pX, platoon unblocked	0.92	0.92		0.92	0.92	0.92					0.92	
vC, conflicting volume	1648	1537	368	1167	1535	729	736				731	
vC1, stage 1 conf vol												
vC2, stage 2 conf vol												
vCu, unblocked vol	1660	1540	368	1138	1538	663	736				665	
tC, single (s)	7.5	6.5	6.9	7.5	6.5	6.9	4.1				4.1	
tC, 2 stage (s)												
tF (s)	3.5	4.0	3.3	3.5	4.0	3.3	2.2				2.2	
p0 queue free %	100	100	100	63	100	70	100				96	
cM capacity (veh/h)	41	103	635	142	103	376	865				848	
Direction, Lane #	SE 1	NW 1	NW 2	NE 1	SW 1	SW 2						
Volume Total	0	52	113	731	403	369						
Volume Left	0	52	0	0	35	0						
Volume Right	0	0	113	4	0	1						
cSH	1700	142	376	865	848	1700						
Volume to Capacity	0.00	0.37	0.30	0.00	0.04	0.22						
Queue Length 95th (ft)	0	38	31	0	3	0						
Control Delay (s/veh)	0.0	44.4	18.6	0.0	1.3	0.0						
Lane LOS	A	E	C		A							
Approach Delay (s/veh)	0.0	26.8		0.0	0.7							
Approach LOS	A	D										
Intersection Summary												
Average Delay			3.0									
Intersection Capacity Utilization			49.5%	ICU Level of Service	A							
Analysis Period (min)			15									

10: Dover Road & Site Driveway



Movement	SEL	SER	NEL	NET	SWT	SWR
Lane Configurations						
Traffic Volume (veh/h)	0	0	0	682	656	0
Future Volume (Veh/h)	0	0	0	682	656	0
Sign Control	Stop			Free	Free	
Grade	0%			-3%	3%	
Peak Hour Factor	0.25	0.25	0.85	0.85	0.87	0.87
Hourly flow rate (vph)	0	0	0	802	754	0
Pedestrians						
Lane Width (ft)						
Walking Speed (ft/s)						
Percent Blockage						
Right turn flare (veh)						
Median type				None	None	
Median storage veh						
Upstream signal (ft)	313					
pX, platoon unblocked	0.93					
vC, conflicting volume	1556	754	754			
vC1, stage 1 conf vol						
vC2, stage 2 conf vol						
vCu, unblocked vol	1560	754	754			
tC, single (s)	6.4	6.2	4.1			
tC, 2 stage (s)						
tF (s)	3.5	3.3	2.2			
p0 queue free %	100	100	100			
cM capacity (veh/h)	116	412	856			
Direction, Lane #	SE 1	NE 1	SW 1			
Volume Total	0	802	754			
Volume Left	0	0	0			
Volume Right	0	0	0			
cSH	1700	856	1700			
Volume to Capacity	0.00	0.00	0.44			
Queue Length 95th (ft)	0	0	0			
Control Delay (s/veh)	0.0	0.0	0.0			
Lane LOS	A					
Approach Delay (s/veh)	0.0	0.0	0.0			
Approach LOS	A					
Intersection Summary						
Average Delay	0.0					
Intersection Capacity Utilization	39.2%			ICU Level of Service	A	
Analysis Period (min)	15					

2024 Existing Weekday Evening Peak Hour



3: Main Street /Dover Road & Newmarket Road/Holiday Inn Express Driveway

												Ø9
Lane Group	SEL	SET	NWL	NWT	NWR	NEL	NET	NER	SWL	SWT	Ø9	
Lane Configurations												
Traffic Volume (vph)	1	2	139	2	400	12	372	184	464	276		
Future Volume (vph)	1	2	139	2	400	12	372	184	464	276		
Turn Type	Perm	NA	Perm	NA	Perm	Prot	NA	Perm	Prot	NA		
Protected Phases		4		8		5	2		1	6	9	
Permitted Phases	4		8		8			2				
Detector Phase	4	4	8	8	8	5	2	2	1	6		
Switch Phase												
Minimum Initial (s)	5.0	5.0	5.0	5.0	5.0	5.0	5.0	5.0	5.0	5.0	5.0	
Minimum Split (s)	11.0	11.0	11.0	11.0	11.0	16.0	16.0	16.0	16.0	16.0	19.0	
Total Split (s)	36.0	36.0	36.0	36.0	36.0	19.0	36.0	36.0	36.0	53.0	19.0	
Total Split (%)	28.3%	28.3%	28.3%	28.3%	28.3%	15.0%	28.3%	28.3%	28.3%	41.7%	15%	
Yellow Time (s)	4.0	4.0	4.0	4.0	4.0	4.0	4.0	4.0	4.0	4.0	2.0	
All-Red Time (s)	2.0	2.0	2.0	2.0	2.0	2.0	2.0	2.0	2.0	2.0	0.0	
Lost Time Adjust (s)		-2.0		-2.0	-2.0	-2.0	-2.0	-2.0	-2.0	-2.0		
Total Lost Time (s)		4.0		4.0	4.0	4.0	4.0	4.0	4.0	4.0		
Lead/Lag						Lead	Lag	Lag	Lead	Lag		
Lead-Lag Optimize?						Yes	Yes	Yes	Yes	Yes		
Recall Mode	Min	Min	Min	Min	Min	None	Min	Min	Max	Min	None	

Intersection Summary

Cycle Length: 127
 Actuated Cycle Length: 101.7
 Natural Cycle: 90
 Control Type: Semi Act-Uncoord

Splits and Phases: 3: Main Street /Dover Road & Newmarket Road/Holiday Inn Express Driveway



3: Main Street /Dover Road & Newmarket Road/Holiday Inn Express Driveway

01/07/2025



Lane Group	SET	NWT	NWR	NEL	NET	NER	SWL	SWT
Lane Group Flow (vph)	20	172	488	14	448	222	494	298
v/c Ratio	0.05	0.57	0.66	0.08	0.73	0.34	0.86	0.26
Control Delay (s/veh)	19.1	44.0	8.0	48.0	42.3	6.2	51.4	13.1
Queue Delay	0.0	0.0	0.0	0.0	0.0	0.0	0.0	0.0
Total Delay (s/veh)	19.1	44.0	8.0	48.0	42.3	6.2	51.4	13.1
Queue Length 50th (ft)	3	97	0	8	246	0	295	65
Queue Length 95th (ft)	10	178	45	30	434	45	#675	249
Internal Link Dist (ft)	1	409			368			56
Turn Bay Length (ft)			155	35		300		
Base Capacity (vph)	530	407	834	270	669	684	573	1139
Starvation Cap Reductn	0	0	0	0	0	0	0	0
Spillback Cap Reductn	0	0	0	0	0	0	0	0
Storage Cap Reductn	0	0	0	0	0	0	0	0
Reduced v/c Ratio	0.04	0.42	0.59	0.05	0.67	0.32	0.86	0.26

Intersection Summary
 # 95th percentile volume exceeds capacity, queue may be longer.
 Queue shown is maximum after two cycles.

3: Main Street /Dover Road & Newmarket Road/Holiday Inn Express Driveway

01/07/2025



Movement	SEL	SET	SER	NWL	NWT	NWR	NEL	NET	NER	SWL	SWT	SWR
Lane Configurations		↔			↔	↔	↔	↔	↔	↔	↔	↔
Traffic Volume (vph)	1	2	7	139	2	400	12	372	184	464	276	4
Future Volume (vph)	1	2	7	139	2	400	12	372	184	464	276	4
Ideal Flow (vphpl)	1900	1900	1900	1900	1900	1900	1900	1900	1900	1900	1900	1900
Lane Width	12	11	12	12	11	12	11	14	12	12	11	12
Grade (%)		0%			4%			-6%			0%	
Total Lost time (s)		4.0			4.0	4.0	4.0	4.0	4.0	4.0	4.0	
Lane Util. Factor		1.00			1.00	1.00	1.00	1.00	1.00	1.00	1.00	
Frbp, ped/bikes		1.00			1.00	1.00	1.00	1.00	1.00	1.00	1.00	
Flpb, ped/bikes		1.00			1.00	1.00	1.00	1.00	1.00	1.00	1.00	
Frt		0.91			1.00	0.85	1.00	1.00	0.85	1.00	1.00	
Flt Protected		1.00			0.95	1.00	0.95	1.00	1.00	0.95	1.00	
Satd. Flow (prot)		1655			1698	1567	1797	2087	1663	1787	1814	
Flt Permitted		0.98			0.71	1.00	0.95	1.00	1.00	0.95	1.00	
Satd. Flow (perm)		1625			1273	1567	1797	2087	1663	1787	1814	
Peak-hour factor, PHF	0.50	0.50	0.50	0.82	0.82	0.82	0.83	0.83	0.83	0.94	0.94	0.94
Adj. Flow (vph)	2	4	14	170	2	488	14	448	222	494	294	4
RTOR Reduction (vph)	0	11	0	0	0	380	0	0	150	0	0	0
Lane Group Flow (vph)	0	9	0	0	172	108	14	448	72	494	298	0
Confl. Bikes (#/hr)												2
Heavy Vehicles (%)	0%	0%	0%	1%	1%	1%	0%	0%	0%	1%	1%	1%
Turn Type	Perm	NA		Perm	NA	Perm	Prot	NA	Perm	Prot	NA	
Protected Phases		4			8		5	2		1	6	
Permitted Phases	4			8		8			2			
Actuated Green, G (s)		22.0			22.0	22.0	1.6	32.9	32.9	30.6	61.9	
Effective Green, g (s)		24.0			24.0	24.0	3.6	34.9	34.9	32.6	63.9	
Actuated g/C Ratio		0.22			0.22	0.22	0.03	0.32	0.32	0.30	0.59	
Clearance Time (s)		6.0			6.0	6.0	6.0	6.0	6.0	6.0	6.0	
Vehicle Extension (s)		5.0			5.0	5.0	5.0	5.0	5.0	5.0	5.0	
Lane Grp Cap (vph)		360			282	347	59	673	536	538	1071	
v/s Ratio Prot							0.01	c0.21		c0.28	0.16	
v/s Ratio Perm		0.01			c0.14	0.07			0.04			
v/c Ratio		0.03			0.61	0.31	0.24	0.67	0.13	0.92	0.28	

3: Main Street /Dover Road & Newmarket Road/Holiday Inn Express Driveway

01/07/2025



Movement	SEL	SET	SER	NWL	NWT	NWR	NEL	NET	NER	SWL	SWT	SWR
Uniform Delay, d1		32.9			37.9	35.2	51.0	31.6	25.9	36.5	10.8	
Progression Factor		1.00			1.00	1.00	1.00	1.00	1.00	1.00	1.00	
Incremental Delay, d2		0.1			5.4	1.1	4.3	3.3	0.2	23.1	0.3	
Delay (s)		33.0			43.3	36.3	55.3	34.9	26.2	59.6	11.1	
Level of Service		C			D	D	E	C	C	E	B	
Approach Delay (s/veh)		33.0			38.1			32.5			41.4	
Approach LOS		C			D			C			D	

Intersection Summary			
HCM 2000 Control Delay (s/veh)	37.5	HCM 2000 Level of Service	D
HCM 2000 Volume to Capacity ratio	0.72		
Actuated Cycle Length (s)	108.2	Sum of lost time (s)	14.0
Intersection Capacity Utilization	69.8%	ICU Level of Service	C
Analysis Period (min)	15		

c Critical Lane Group

5: Dover Road & Irving Gas Station Driveway

01/07/2025



Movement	NWL	NWR	NET	NER	SWL	SWT
Lane Configurations			↔			↔↔
Traffic Volume (veh/h)	0	0	708	65	3	744
Future Volume (Veh/h)	0	0	708	65	3	744
Sign Control	Stop		Free		Free	
Grade	0%		-3%		3%	
Peak Hour Factor	0.92	0.92	0.83	0.83	0.93	0.93
Hourly flow rate (vph)	0	0	853	78	3	800
Pedestrians	5					
Lane Width (ft)	0.0					
Walking Speed (ft/s)	3.5					
Percent Blockage	0					
Right turn flare (veh)						
Median type	None			None		
Median storage veh						
Upstream signal (ft)	136					
pX, platoon unblocked	0.81	0.81			0.81	
vC, conflicting volume	1303	897			936	
vC1, stage 1 conf vol						
vC2, stage 2 conf vol						
vCu, unblocked vol	1257	756			804	
tC, single (s)	6.8	6.9			4.1	
tC, 2 stage (s)						
tF (s)	3.5	3.3			2.2	
p0 queue free %	100	100			100	
cM capacity (veh/h)	134	288			666	
Direction, Lane #	NE 1	SW 1	SW 2			
Volume Total	931	270	533			
Volume Left	0	3	0			
Volume Right	78	0	0			
cSH	1700	666	1700			
Volume to Capacity	0.55	0.00	0.31			
Queue Length 95th (ft)	0	0	0			
Control Delay (s/veh)	0.0	0.2	0.0			
Lane LOS	A					
Approach Delay (s/veh)	0.0	0.1				
Approach LOS						
Intersection Summary						
Average Delay			0.0			
Intersection Capacity Utilization			44.6%	ICU Level of Service		A
Analysis Period (min)			15			



Movement	SEL	SET	SER	NWL	NWT	NWR	NEL	NET	NER	SWL	SWT	SWR
Lane Configurations		↕			↕	↕		↕			↕	↕
Traffic Volume (veh/h)	0	0	0	31	0	57	0	704	4	20	716	2
Future Volume (Veh/h)	0	0	0	31	0	57	0	704	4	20	716	2
Sign Control		Stop			Stop			Free			Free	
Grade		0%			0%			-3%			3%	
Peak Hour Factor	0.25	0.25	0.25	0.79	0.79	0.79	0.84	0.84	0.84	0.93	0.93	0.93
Hourly flow rate (vph)	0	0	0	39	0	72	0	838	5	22	770	2
Pedestrians		5			12			12			12	
Lane Width (ft)		11.0			10.0			12.0			12.0	
Walking Speed (ft/s)		3.5			3.5			3.5			3.5	
Percent Blockage		0			1			1			1	
Right turn flare (veh)												
Median type								None			None	
Median storage veh												
Upstream signal (ft)								223				
pX, platoon unblocked	0.81	0.81		0.81	0.81	0.81				0.81		
vC, conflicting volume	1745	1675	403	1294	1674	865	777			855		
vC1, stage 1 conf vol												
vC2, stage 2 conf vol												
vCu, unblocked vol	1801	1715	403	1246	1713	718	777			706		
tC, single (s)	7.5	6.5	6.9	7.5	6.5	6.9	4.1			4.1		
tC, 2 stage (s)												
tF (s)	3.5	4.0	3.3	3.5	4.0	3.3	2.2			2.2		
p0 queue free %	100	100	100	62	100	76	100			97		
cM capacity (veh/h)	30	71	593	102	71	299	838			720		
Direction, Lane #	SE 1	NW 1	NW 2	NE 1	SW 1	SW 2						
Volume Total	0	39	72	843	407	387						
Volume Left	0	39	0	0	22	0						
Volume Right	0	0	72	5	0	2						
cSH	1700	102	299	838	720	1700						
Volume to Capacity	0.00	0.38	0.24	0.00	0.03	0.23						
Queue Length 95th (ft)	0	39	23	0	2	0						
Control Delay (s/veh)	0.0	60.8	20.8	0.0	0.9	0.0						
Lane LOS	A	F	C		A							
Approach Delay (s/veh)	0.0	34.9		0.0	0.5							
Approach LOS	A	D										
Intersection Summary												
Average Delay			2.4									
Intersection Capacity Utilization			51.6%		ICU Level of Service				A			
Analysis Period (min)			15									

10: Dover Road & Site Driveway



Movement	SEL	SER	NEL	NET	SWT	SWR
Lane Configurations						
Traffic Volume (veh/h)	0	0	0	761	738	0
Future Volume (Veh/h)	0	0	0	761	738	0
Sign Control	Stop			Free	Free	
Grade	0%			-3%	3%	
Peak Hour Factor	0.25	0.25	0.85	0.85	0.94	0.94
Hourly flow rate (vph)	0	0	0	895	785	0
Pedestrians	7			7	7	
Lane Width (ft)	12.0			11.0	12.0	
Walking Speed (ft/s)	3.5			3.5	3.5	
Percent Blockage	1			1	1	
Right turn flare (veh)						
Median type				None	None	
Median storage veh						
Upstream signal (ft)				313		
pX, platoon unblocked	0.81					
vC, conflicting volume	1694	799	792			
vC1, stage 1 conf vol						
vC2, stage 2 conf vol						
vCu, unblocked vol	1739	799	792			
tC, single (s)	6.4	6.2	4.1			
tC, 2 stage (s)						
tF (s)	3.5	3.3	2.2			
p0 queue free %	100	100	100			
cM capacity (veh/h)	78	384	828			
Direction, Lane #	SE 1	NE 1	SW 1			
Volume Total	0	895	785			
Volume Left	0	0	0			
Volume Right	0	0	0			
cSH	1700	828	1700			
Volume to Capacity	0.00	0.00	0.46			
Queue Length 95th (ft)	0	0	0			
Control Delay (s/veh)	0.0	0.0	0.0			
Lane LOS	A					
Approach Delay (s/veh)	0.0	0.0	0.0			
Approach LOS	A					
Intersection Summary						
Average Delay				0.0		
Intersection Capacity Utilization				52.1%	ICU Level of Service	A
Analysis Period (min)				15		

2024 Existing Saturday Midday Peak Hour



3: Main Street /Dover Road & Newmarket Road/Holiday Inn Express Driveway

01/07/2025

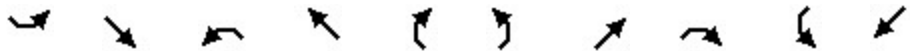

Lane Group	SEL	SET	NWL	NWT	NWR	NEL	NET	NER	SWL	SWT	Ø9
Lane Configurations		↔		↕	↗	↘	↖	↗	↘	↖	↗
Traffic Volume (vph)	4	2	155	0	373	7	400	241	465	308	
Future Volume (vph)	4	2	155	0	373	7	400	241	465	308	
Turn Type	Perm	NA	Perm	NA	Perm	Prot	NA	Perm	Prot	NA	
Protected Phases		4		8		5	2		1	6	9
Permitted Phases	4		8		8			2			
Detector Phase	4	4	8	8	8	5	2	2	1	6	
Switch Phase											
Minimum Initial (s)	5.0	5.0	5.0	5.0	5.0	5.0	5.0	5.0	5.0	5.0	5.0
Minimum Split (s)	11.0	11.0	11.0	11.0	11.0	16.0	16.0	16.0	16.0	16.0	19.0
Total Split (s)	36.0	36.0	36.0	36.0	36.0	19.0	36.0	36.0	36.0	53.0	19.0
Total Split (%)	28.3%	28.3%	28.3%	28.3%	28.3%	15.0%	28.3%	28.3%	28.3%	41.7%	15%
Yellow Time (s)	4.0	4.0	4.0	4.0	4.0	4.0	4.0	4.0	4.0	4.0	2.0
All-Red Time (s)	2.0	2.0	2.0	2.0	2.0	2.0	2.0	2.0	2.0	2.0	0.0
Lost Time Adjust (s)		-2.0		-2.0	-2.0	-2.0	-2.0	-2.0	-2.0	-2.0	
Total Lost Time (s)		4.0		4.0	4.0	4.0	4.0	4.0	4.0	4.0	
Lead/Lag						Lead	Lag	Lag	Lead	Lag	
Lead-Lag Optimize?						Yes	Yes	Yes	Yes	Yes	
Recall Mode	Min	Min	Min	Min	Min	None	Min	Min	Max	Min	None

Intersection Summary

Cycle Length: 127
 Actuated Cycle Length: 107
 Natural Cycle: 90
 Control Type: Semi Act-Uncoord

Splits and Phases: 3: Main Street /Dover Road & Newmarket Road/Holiday Inn Express Driveway

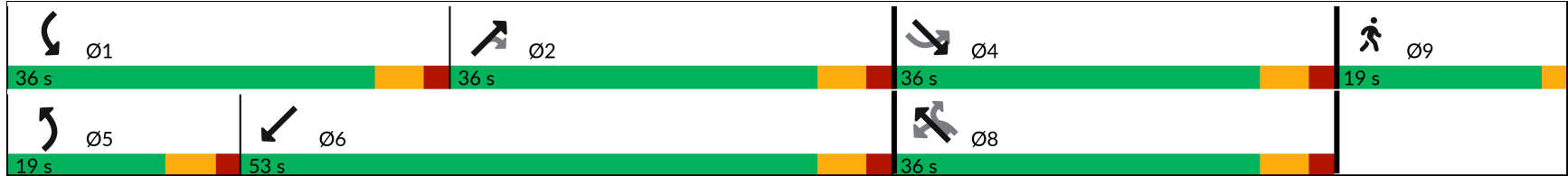

3: Main Street /Dover Road & Newmarket Road/Holiday Inn Express Driveway

01/07/2025



Lane Group	SET	NWT	NWR	NEL	NET	NER	SWL	SWT
Lane Group Flow (vph)	24	174	419	8	482	290	541	359
v/c Ratio	0.07	0.59	0.62	0.05	0.80	0.43	0.99	0.32
Control Delay (s/veh)	21.0	47.3	8.1	52.1	48.3	6.4	75.5	15.6
Queue Delay	0.0	0.0	0.0	0.0	0.0	0.0	0.0	0.0
Total Delay (s/veh)	21.0	47.3	8.1	52.1	48.3	6.4	75.5	15.6
Queue Length 50th (ft)	4	98	0	5	270	0	333	80
Queue Length 95th (ft)	19	199	80	21	#510	48	#711	286
Internal Link Dist (ft)	1	409			368			56
Turn Bay Length (ft)			155	35		300		
Base Capacity (vph)	491	401	766	255	633	695	547	1116
Starvation Cap Reductn	0	0	0	0	0	0	0	0
Spillback Cap Reductn	0	0	0	0	0	0	0	0
Storage Cap Reductn	0	0	0	0	0	0	0	0
Reduced v/c Ratio	0.05	0.43	0.55	0.03	0.76	0.42	0.99	0.32

Intersection Summary

95th percentile volume exceeds capacity, queue may be longer.
 Queue shown is maximum after two cycles.

3: Main Street /Dover Road & Newmarket Road/Holiday Inn Express Driveway

01/07/2025



Movement	SEL	SET	SER	NWL	NWT	NWR	NEL	NET	NER	SWL	SWT	SWR
Lane Configurations		↕			↕	↕	↕	↕	↕	↕	↕	↕
Traffic Volume (vph)	4	2	10	155	0	373	7	400	241	465	308	1
Future Volume (vph)	4	2	10	155	0	373	7	400	241	465	308	1
Ideal Flow (vphpl)	1900	1900	1900	1900	1900	1900	1900	1900	1900	1900	1900	1900
Lane Width	12	11	12	12	11	12	11	14	12	12	11	12
Grade (%)		0%			4%			-6%			0%	
Total Lost time (s)		4.0			4.0	4.0	4.0	4.0	4.0	4.0	4.0	
Lane Util. Factor		1.00			1.00	1.00	1.00	1.00	1.00	1.00	1.00	
Frbp, ped/bikes		1.00			1.00	1.00	1.00	1.00	0.98	1.00	1.00	
Flpb, ped/bikes		1.00			1.00	1.00	1.00	1.00	1.00	1.00	1.00	
Frt		0.92			1.00	0.85	1.00	1.00	0.85	1.00	1.00	
Flt Protected		0.99			0.95	1.00	0.95	1.00	1.00	0.95	1.00	
Satd. Flow (prot)		1661			1676	1552	1779	2067	1612	1787	1818	
Flt Permitted		0.93			0.74	1.00	0.95	1.00	1.00	0.95	1.00	
Satd. Flow (perm)		1567			1309	1552	1779	2067	1612	1787	1818	
Peak-hour factor, PHF	0.67	0.67	0.67	0.89	0.89	0.89	0.83	0.83	0.83	0.86	0.86	0.86
Adj. Flow (vph)	6	3	15	174	0	419	8	482	290	541	358	1
RTOR Reduction (vph)	0	12	0	0	0	330	0	0	196	0	0	0
Lane Group Flow (vph)	0	12	0	0	174	89	8	482	94	541	359	0
Confl. Bikes (#/hr)									1			2
Heavy Vehicles (%)	0%	0%	0%	2%	2%	2%	1%	1%	1%	1%	1%	1%
Turn Type	Perm	NA		Perm	NA	Perm	Prot	NA	Perm	Prot	NA	
Protected Phases		4			8		5	2		1	6	
Permitted Phases	4			8		8			2			
Actuated Green, G (s)		22.1			22.1	22.1	1.6	34.5	34.5	30.8	63.7	
Effective Green, g (s)		24.1			24.1	24.1	3.6	36.5	36.5	32.8	65.7	
Actuated g/C Ratio		0.21			0.21	0.21	0.03	0.32	0.32	0.29	0.58	
Clearance Time (s)		6.0			6.0	6.0	6.0	6.0	6.0	6.0	6.0	
Vehicle Extension (s)		5.0			5.0	5.0	5.0	5.0	5.0	5.0	5.0	
Lane Grp Cap (vph)		333			278	330	56	667	520	518	1056	
v/s Ratio Prot							0.00	c0.23		c0.30	0.20	
v/s Ratio Perm		0.01			c0.13	0.06			0.06			
v/c Ratio		0.04			0.63	0.27	0.14	0.72	0.18	1.04	0.34	

3: Main Street /Dover Road & Newmarket Road/Holiday Inn Express Driveway

01/07/2025



Movement	SEL	SET	SER	NWL	NWT	NWR	NEL	NET	NER	SWL	SWT	SWR
Uniform Delay, d1		35.3			40.4	37.2	53.2	33.8	27.5	40.2	12.4	
Progression Factor		1.00			1.00	1.00	1.00	1.00	1.00	1.00	1.00	
Incremental Delay, d2		0.1			6.1	0.9	2.4	4.7	0.3	51.6	0.4	
Delay (s)		35.4			46.5	38.1	55.7	38.6	27.9	91.8	12.8	
Level of Service		D			D	D	E	D	C	F	B	
Approach Delay (s/veh)		35.4			40.6			34.8			60.3	
Approach LOS		D			D			C			E	

Intersection Summary		
HCM 2000 Control Delay (s/veh)	46.3	HCM 2000 Level of Service D
HCM 2000 Volume to Capacity ratio	0.76	
Actuated Cycle Length (s)	113.1	Sum of lost time (s) 14.0
Intersection Capacity Utilization	72.1%	ICU Level of Service C
Analysis Period (min)	15	

c Critical Lane Group

5: Dover Road & Irving Gas Station Driveway

01/07/2025



Movement	NWL	NWR	NET	NER	SWL	SWT
Lane Configurations			↔			↔↔
Traffic Volume (veh/h)	0	0	692	85	3	774
Future Volume (Veh/h)	0	0	692	85	3	774
Sign Control	Stop		Free		Free	
Grade	0%		-3%		3%	
Peak Hour Factor	0.92	0.92	0.83	0.83	0.95	0.95
Hourly flow rate (vph)	0	0	834	102	3	815
Pedestrians	2					
Lane Width (ft)	0.0					
Walking Speed (ft/s)	3.5					
Percent Blockage	0					
Right turn flare (veh)						
Median type	None			None		
Median storage veh						
Upstream signal (ft)	136					
pX, platoon unblocked	0.79	0.79			0.79	
vC, conflicting volume	1301	887			938	
vC1, stage 1 conf vol						
vC2, stage 2 conf vol						
vCu, unblocked vol	1247	723			788	
tC, single (s)	6.8	6.9			4.1	
tC, 2 stage (s)						
tF (s)	3.5	3.3			2.2	
p0 queue free %	100	100			100	
cM capacity (veh/h)	132	294			658	
Direction, Lane #	NE 1	SW 1	SW 2			
Volume Total	936	275	543			
Volume Left	0	3	0			
Volume Right	102	0	0			
cSH	1700	658	1700			
Volume to Capacity	0.55	0.00	0.32			
Queue Length 95th (ft)	0	0	0			
Control Delay (s/veh)	0.0	0.2	0.0			
Lane LOS	A					
Approach Delay (s/veh)	0.0	0.1				
Approach LOS						
Intersection Summary						
Average Delay	0.0					
Intersection Capacity Utilization	44.9%			ICU Level of Service	A	
Analysis Period (min)	15					



Movement	SEL	SET	SER	NWL	NWT	NWR	NEL	NET	NER	SWL	SWT	SWR
Lane Configurations		↕			↕	↕		↕			↕	↕
Traffic Volume (veh/h)	1	0	2	48	0	73	0	688	4	25	727	2
Future Volume (Veh/h)	1	0	2	48	0	73	0	688	4	25	727	2
Sign Control		Stop			Stop			Free			Free	
Grade		0%			0%			-3%			3%	
Peak Hour Factor	0.38	0.38	0.38	0.82	0.82	0.82	0.88	0.88	0.88	0.95	0.95	0.95
Hourly flow rate (vph)	3	0	5	59	0	89	0	782	5	26	765	2
Pedestrians		5			2			7			5	
Lane Width (ft)		11.0			10.0			12.0			12.0	
Walking Speed (ft/s)		3.5			3.5			3.5			3.5	
Percent Blockage		0			0			1			0	
Right turn flare (veh)												
Median type								None			None	
Median storage veh												
Upstream signal (ft)								223				
pX, platoon unblocked	0.79	0.79		0.79	0.79	0.79				0.79		
vC, conflicting volume	1702	1612	396	1233	1611	792	772			789		
vC1, stage 1 conf vol												
vC2, stage 2 conf vol												
vCu, unblocked vol	1754	1641	396	1164	1639	609	772			605		
tC, single (s)	7.5	6.5	6.9	7.5	6.5	6.9	4.1			4.1		
tC, 2 stage (s)												
tF (s)	3.5	4.0	3.3	3.5	4.0	3.3	2.2			2.2		
p0 queue free %	91	100	99	49	100	75	100			97		
cM capacity (veh/h)	32	77	603	115	77	350	842			774		
Direction, Lane #	SE 1	NW 1	NW 2	NE 1	SW 1	SW 2						
Volume Total	8	59	89	787	409	385						
Volume Left	3	59	0	0	26	0						
Volume Right	5	0	89	5	0	2						
cSH	78	115	350	842	774	1700						
Volume to Capacity	0.10	0.51	0.25	0.00	0.03	0.23						
Queue Length 95th (ft)	8	59	25	0	3	0						
Control Delay (s/veh)	56.7	65.2	18.8	0.0	1.0	0.0						
Lane LOS	F	F	C		A							
Approach Delay (s/veh)	56.7	37.3		0.0	0.5							
Approach LOS	F	E										
Intersection Summary												
Average Delay			3.7									
Intersection Capacity Utilization			57.2%		ICU Level of Service				B			
Analysis Period (min)			15									

10: Dover Road & Site Driveway



Movement	SEL	SER	NEL	NET	SWT	SWR
Lane Configurations						
Traffic Volume (veh/h)	0	0	0	762	754	0
Future Volume (Veh/h)	0	0	0	762	754	0
Sign Control	Stop			Free	Free	
Grade	0%			-3%	3%	
Peak Hour Factor	0.25	0.25	0.88	0.88	0.95	0.95
Hourly flow rate (vph)	0	0	0	866	794	0
Pedestrians						
Lane Width (ft)						
Walking Speed (ft/s)						
Percent Blockage						
Right turn flare (veh)						
Median type				None	None	
Median storage veh						
Upstream signal (ft)	313					
pX, platoon unblocked	0.80					
vC, conflicting volume	1660	794	794			
vC1, stage 1 conf vol						
vC2, stage 2 conf vol						
vCu, unblocked vol	1701	794	794			
tC, single (s)	6.4	6.2	4.1			
tC, 2 stage (s)						
tF (s)	3.5	3.3	2.2			
p0 queue free %	100	100	100			
cM capacity (veh/h)	81	391	832			
Direction, Lane #	SE 1	NE 1	SW 1			
Volume Total	0	866	794			
Volume Left	0	0	0			
Volume Right	0	0	0			
cSH	1700	832	1700			
Volume to Capacity	0.00	0.00	0.47			
Queue Length 95th (ft)	0	0	0			
Control Delay (s/veh)	0.0	0.0	0.0			
Lane LOS	A					
Approach Delay (s/veh)	0.0	0.0	0.0			
Approach LOS	A					
Intersection Summary						
Average Delay	0.0					
Intersection Capacity Utilization	43.4%			ICU Level of Service	A	
Analysis Period (min)	15					

2025 Opening Year No-Build Weekday Morning Peak Hour



3: Main Street /Dover Road & Newmarket Road/Holiday Inn Express Driveway

01/10/2025



Lane Group	SEL	SET	NWL	NWT	NWR	NEL	NET	NER	SWL	SWT	Ø9
Lane Configurations		↕		↕	↕	↕	↕	↕	↕	↕	
Traffic Volume (vph)	3	0	156	0	488	2	176	96	399	261	
Future Volume (vph)	3	0	156	0	488	2	176	96	399	261	
Turn Type	Perm	NA	Perm	NA	Perm	Prot	NA	Perm	Prot	NA	
Protected Phases		4		8		5	2		1	6	9
Permitted Phases	4		8		8			2			
Detector Phase	4	4	8	8	8	5	2	2	1	6	
Switch Phase											
Minimum Initial (s)	5.0	5.0	5.0	5.0	5.0	5.0	5.0	5.0	5.0	5.0	5.0
Minimum Split (s)	11.0	11.0	11.0	11.0	11.0	16.0	16.0	16.0	16.0	16.0	20.0
Total Split (s)	36.0	36.0	36.0	36.0	36.0	19.0	36.0	36.0	36.0	53.0	19.0
Total Split (%)	28.3%	28.3%	28.3%	28.3%	28.3%	15.0%	28.3%	28.3%	28.3%	41.7%	15%
Yellow Time (s)	4.0	4.0	4.0	4.0	4.0	4.0	4.0	4.0	4.0	4.0	2.0
All-Red Time (s)	2.0	2.0	2.0	2.0	2.0	2.0	2.0	2.0	2.0	2.0	0.0
Lost Time Adjust (s)		-2.0		-2.0	-2.0	-2.0	-2.0	-2.0	-2.0	-2.0	
Total Lost Time (s)		4.0		4.0	4.0	4.0	4.0	4.0	4.0	4.0	
Lead/Lag						Lead	Lag	Lag	Lead	Lag	
Lead-Lag Optimize?						Yes	Yes	Yes	Yes	Yes	
Recall Mode	Min	Min	Min	Min	Min	None	Min	Min	Max	Min	None

Intersection Summary

Cycle Length: 127
 Actuated Cycle Length: 92.5
 Natural Cycle: 80
 Control Type: Semi Act-Uncoord

Splits and Phases: 3: Main Street /Dover Road & Newmarket Road/Holiday Inn Express Driveway

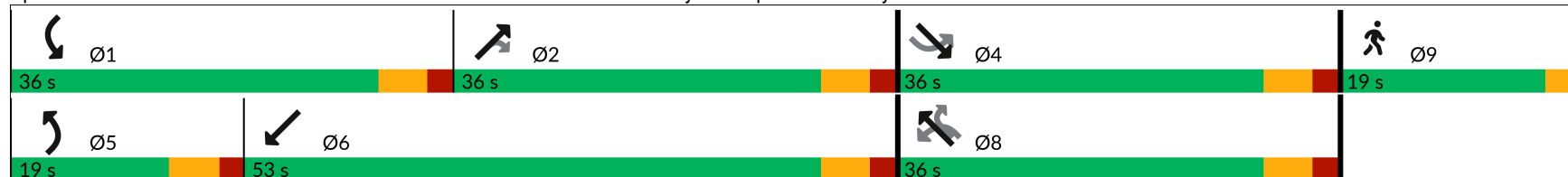

Timings

S:\Jobs\10078 - Durham, NH\Synchro\2025 Opening Year No-Build AM.syn

3: Main Street /Dover Road & Newmarket Road/Holiday Inn Express Driveway

01/10/2025



Lane Group	SET	NWT	NWR	NEL	NET	NER	SWL	SWT
Lane Group Flow (vph)	12	200	626	2	200	109	459	300
v/c Ratio	0.02	0.55	0.71	0.01	0.49	0.25	0.73	0.29
Control Delay (s/veh)	0.0	37.3	7.8	46.0	38.8	3.9	37.8	14.5
Queue Delay	0.0	0.0	0.0	0.0	0.0	0.0	0.0	0.0
Total Delay (s/veh)	0.0	37.3	7.8	46.0	38.8	3.9	37.8	14.5
Queue Length 50th (ft)	0	92	0	1	98	0	217	70
Queue Length 95th (ft)	0	188	21	10	209	20	#566	240
Internal Link Dist (ft)	1	409			368			56
Turn Bay Length (ft)			155	35		300		
Base Capacity (vph)	631	476	961	286	709	658	625	1040
Starvation Cap Reductn	0	0	0	0	0	0	0	0
Spillback Cap Reductn	0	0	0	0	0	0	0	0
Storage Cap Reductn	0	0	0	0	0	0	0	0
Reduced v/c Ratio	0.02	0.42	0.65	0.01	0.28	0.17	0.73	0.29

Intersection Summary

95th percentile volume exceeds capacity, queue may be longer.
 Queue shown is maximum after two cycles.

3: Main Street /Dover Road & Newmarket Road/Holiday Inn Express Driveway

01/10/2025



Movement	SEL	SET	SER	NWL	NWT	NWR	NEL	NET	NER	SWL	SWT	SWR
Lane Configurations		↕			↕	↕	↕	↕	↕	↕	↕	↕
Traffic Volume (vph)	3	0	3	156	0	488	2	176	96	399	261	0
Future Volume (vph)	3	0	3	156	0	488	2	176	96	399	261	0
Ideal Flow (vphpl)	1900	1900	1900	1900	1900	1900	1900	1900	1900	1900	1900	1900
Lane Width	12	11	12	12	11	12	11	14	12	12	11	12
Grade (%)		0%			4%			-6%			0%	
Total Lost time (s)		4.0			4.0	4.0	4.0	4.0	4.0	4.0	4.0	
Lane Util. Factor		1.00			1.00	1.00	1.00	1.00	1.00	1.00	1.00	
Frbp, ped/bikes		1.00			1.00	1.00	1.00	1.00	1.00	1.00	1.00	
Flpb, ped/bikes		1.00			1.00	1.00	1.00	1.00	1.00	1.00	1.00	
Frt		0.93			1.00	0.85	1.00	1.00	0.85	1.00	1.00	
Flt Protected		0.98			0.95	1.00	0.95	1.00	1.00	0.95	1.00	
Satd. Flow (prot)		1671			1693	1567	1712	1988	1584	1752	1783	
Flt Permitted		0.88			0.75	1.00	0.95	1.00	1.00	0.95	1.00	
Satd. Flow (perm)		1508			1336	1567	1712	1988	1584	1752	1783	
Peak-hour factor, PHF	0.50	0.50	0.50	0.78	0.78	0.78	0.88	0.88	0.88	0.87	0.87	0.87
Adj. Flow (vph)	6	0	6	200	0	626	2	200	109	459	300	0
RTOR Reduction (vph)	0	9	0	0	0	467	0	0	82	0	0	0
Lane Group Flow (vph)	0	3	0	0	200	159	2	200	27	459	300	0
Confl. Bikes (#/hr)												2
Heavy Vehicles (%)	0%	0%	0%	1%	1%	1%	5%	5%	5%	3%	3%	3%
Turn Type	Perm	NA		Perm	NA	Perm	Prot	NA	Perm	Prot	NA	
Protected Phases		4			8		5	2		1	6	
Permitted Phases	4			8		8			2			
Actuated Green, G (s)		23.1			23.1	23.1	1.2	22.2	22.2	30.9	51.9	
Effective Green, g (s)		25.1			25.1	25.1	3.2	24.2	24.2	32.9	53.9	
Actuated g/C Ratio		0.25			0.25	0.25	0.03	0.24	0.24	0.33	0.54	
Clearance Time (s)		6.0			6.0	6.0	6.0	6.0	6.0	6.0	6.0	
Vehicle Extension (s)		5.0			5.0	5.0	5.0	5.0	5.0	5.0	5.0	
Lane Grp Cap (vph)		382			339	397	55	486	387	582	971	
v/s Ratio Prot							0.00	c0.10		c0.26	0.17	
v/s Ratio Perm		0.00			c0.15	0.10			0.02			
v/c Ratio		0.01			0.59	0.40	0.04	0.41	0.07	0.79	0.31	

3: Main Street /Dover Road & Newmarket Road/Holiday Inn Express Driveway

01/10/2025



Movement	SEL	SET	SER	NWL	NWT	NWR	NEL	NET	NER	SWL	SWT	SWR	
Uniform Delay, d1		27.6			32.4	30.6	46.4	31.4	28.7	29.9	12.3		
Progression Factor		1.00			1.00	1.00	1.00	1.00	1.00	1.00	1.00		
Incremental Delay, d2		0.0			4.0	1.4	0.6	1.2	0.2	10.4	0.4		
Delay (s)		27.6			36.4	32.0	46.9	32.6	28.9	40.3	12.7		
Level of Service		C			D	C	D	C	C	D	B		
Approach Delay (s/veh)		27.6			33.1			31.4			29.4		
Approach LOS		C			C			C			C		
Intersection Summary													
HCM 2000 Control Delay (s/veh)			31.3		HCM 2000 Level of Service					C			
HCM 2000 Volume to Capacity ratio			0.60										
Actuated Cycle Length (s)			98.9		Sum of lost time (s)					14.0			
Intersection Capacity Utilization			56.6%		ICU Level of Service					B			
Analysis Period (min)			15										

c Critical Lane Group



Movement	NWL	NWR	NET	NER	SWL	SWT
Lane Configurations			↔			↔↔
Traffic Volume (veh/h)	0	0	621	46	5	660
Future Volume (Veh/h)	0	0	621	46	5	660
Sign Control	Stop		Free			Free
Grade	0%		-3%			3%
Peak Hour Factor	0.92	0.92	0.88	0.88	0.87	0.87
Hourly flow rate (vph)	0	0	706	52	6	759
Pedestrians						
Lane Width (ft)						
Walking Speed (ft/s)						
Percent Blockage						
Right turn flare (veh)						
Median type			None			None
Median storage veh						
Upstream signal (ft)			136			
pX, platoon unblocked	0.92	0.92			0.92	
vC, conflicting volume	1124	732			758	
vC1, stage 1 conf vol						
vC2, stage 2 conf vol						
vCu, unblocked vol	1089	662			691	
tC, single (s)	6.8	6.9			4.2	
tC, 2 stage (s)						
tF (s)	3.5	3.3			2.2	
p0 queue free %	100	100			99	
cM capacity (veh/h)	194	375			819	
Direction, Lane #	NE 1	SW 1	SW 2			
Volume Total	758	259	506			
Volume Left	0	6	0			
Volume Right	52	0	0			
cSH	1700	819	1700			
Volume to Capacity	0.45	0.01	0.30			
Queue Length 95th (ft)	0	1	0			
Control Delay (s/veh)	0.0	0.3	0.0			
Lane LOS			A			
Approach Delay (s/veh)	0.0	0.1				
Approach LOS						
Intersection Summary						
Average Delay			0.1			
Intersection Capacity Utilization			38.8%	ICU Level of Service	A	
Analysis Period (min)			15			

2025 Opening Year No-Build Weekday Morning Peak Hour

7: Dover Road & Irving Gas Station Driveway/Holiday Inn Express Driveway 01/10/2025



Movement	SEL	SET	SER	NWL	NWT	NWR	NEL	NET	NER	SWL	SWT	SWR
Lane Configurations		↔			↔	↔		↔			↔↔	
Traffic Volume (veh/h)	0	0	0	33	0	71	0	618	3	30	632	1
Future Volume (Veh/h)	0	0	0	33	0	71	0	618	3	30	632	1
Sign Control		Stop			Stop			Free			Free	
Grade		0%			0%			-3%			3%	
Peak Hour Factor	0.25	0.25	0.25	0.63	0.63	0.63	0.84	0.84	0.84	0.85	0.85	0.85
Hourly flow rate (vph)	0	0	0	52	0	113	0	736	4	35	744	1
Pedestrians												
Lane Width (ft)												
Walking Speed (ft/s)												
Percent Blockage												
Right turn flare (veh)												
Median type												
Median storage veh												
Upstream signal (ft)												
pX, platoon unblocked	0.92	0.92		0.92	0.92	0.92					0.92	
vC, conflicting volume	1666	1555	373	1180	1553	738	745				740	
vC1, stage 1 conf vol												
vC2, stage 2 conf vol												
vCu, unblocked vol	1680	1559	373	1152	1558	672	745				674	
tC, single (s)	7.5	6.5	6.9	7.5	6.5	6.9	4.1				4.1	
tC, 2 stage (s)												
tF (s)	3.5	4.0	3.3	3.5	4.0	3.3	2.2				2.2	
p0 queue free %	100	100	100	62	100	70	100				96	
cM capacity (veh/h)	39	100	631	138	100	371	859				840	
Direction, Lane #												
	SE 1	NW 1	NW 2	NE 1	SW 1	SW 2						
Volume Total	0	52	113	740	407	373						
Volume Left	0	52	0	0	35	0						
Volume Right	0	0	113	4	0	1						
cSH	1700	138	371	859	840	1700						
Volume to Capacity	0.00	0.38	0.30	0.00	0.04	0.22						
Queue Length 95th (ft)	0	39	32	0	3	0						
Control Delay (s/veh)	0.0	46.0	18.9	0.0	1.3	0.0						
Lane LOS	A	E	C		A							
Approach Delay (s/veh)	0.0	27.4		0.0	0.7							
Approach LOS	A	D										
Intersection Summary												
Average Delay			3.0									
Intersection Capacity Utilization			49.6%		ICU Level of Service				A			
Analysis Period (min)			15									



Movement	SEL	SER	NEL	NET	SWT	SWR
Lane Configurations						
Traffic Volume (veh/h)	0	0	0	689	663	0
Future Volume (Veh/h)	0	0	0	689	663	0
Sign Control	Stop			Free	Free	
Grade	0%			-3%	3%	
Peak Hour Factor	0.25	0.25	0.85	0.85	0.87	0.87
Hourly flow rate (vph)	0	0	0	811	762	0
Pedestrians						
Lane Width (ft)						
Walking Speed (ft/s)						
Percent Blockage						
Right turn flare (veh)						
Median type				None	None	
Median storage veh						
Upstream signal (ft)	313					
pX, platoon unblocked	0.93					
vC, conflicting volume	1573	762	762			
vC1, stage 1 conf vol						
vC2, stage 2 conf vol						
vCu, unblocked vol	1579	762	762			
tC, single (s)	6.4	6.2	4.1			
tC, 2 stage (s)						
tF (s)	3.5	3.3	2.2			
p0 queue free %	100	100	100			
cM capacity (veh/h)	113	408	850			
Direction, Lane #	SE 1	NE 1	SW 1			
Volume Total	0	811	762			
Volume Left	0	0	0			
Volume Right	0	0	0			
cSH	1700	850	1700			
Volume to Capacity	0.00	0.00	0.45			
Queue Length 95th (ft)	0	0	0			
Control Delay (s/veh)	0.0	0.0	0.0			
Lane LOS	A					
Approach Delay (s/veh)	0.0	0.0	0.0			
Approach LOS	A					
Intersection Summary						
Average Delay	0.0					
Intersection Capacity Utilization	39.6%			ICU Level of Service	A	
Analysis Period (min)	15					

2025 Opening Year No-Build Weekday Evening Peak Hour



3: Main Street /Dover Road & Newmarket Road/Holiday Inn Express Driveway

01/10/2025



Lane Group	SEL	SET	NWL	NWT	NWR	NEL	NET	NER	SWL	SWT	Ø9
Lane Configurations		↔		↕	↗	↖	↗	↖	↖	↗	↖
Traffic Volume (vph)	1	2	140	2	404	12	376	186	469	279	
Future Volume (vph)	1	2	140	2	404	12	376	186	469	279	
Turn Type	Perm	NA	Perm	NA	Perm	Prot	NA	Perm	Prot	NA	
Protected Phases		4		8		5	2		1	6	9
Permitted Phases	4		8		8			2			
Detector Phase	4	4	8	8	8	5	2	2	1	6	
Switch Phase											
Minimum Initial (s)	5.0	5.0	5.0	5.0	5.0	5.0	5.0	5.0	5.0	5.0	5.0
Minimum Split (s)	11.0	11.0	11.0	11.0	11.0	16.0	16.0	16.0	16.0	16.0	19.0
Total Split (s)	36.0	36.0	36.0	36.0	36.0	19.0	36.0	36.0	36.0	53.0	19.0
Total Split (%)	28.3%	28.3%	28.3%	28.3%	28.3%	15.0%	28.3%	28.3%	28.3%	41.7%	15%
Yellow Time (s)	4.0	4.0	4.0	4.0	4.0	4.0	4.0	4.0	4.0	4.0	2.0
All-Red Time (s)	2.0	2.0	2.0	2.0	2.0	2.0	2.0	2.0	2.0	2.0	0.0
Lost Time Adjust (s)		-2.0		-2.0	-2.0	-2.0	-2.0	-2.0	-2.0	-2.0	
Total Lost Time (s)		4.0		4.0	4.0	4.0	4.0	4.0	4.0	4.0	
Lead/Lag						Lead	Lag	Lag	Lead	Lag	
Lead-Lag Optimize?						Yes	Yes	Yes	Yes	Yes	
Recall Mode	Min	Min	Min	Min	Min	None	Min	Min	Max	Min	None

Intersection Summary

Cycle Length: 127
 Actuated Cycle Length: 102.2
 Natural Cycle: 90
 Control Type: Semi Act-Uncoord

Splits and Phases: 3: Main Street /Dover Road & Newmarket Road/Holiday Inn Express Driveway



Timings

S:\Jobs\10078 - Durham, NH\Synchro\2025 Opening Year No-Build PM.syn

3: Main Street /Dover Road & Newmarket Road/Holiday Inn Express Driveway

01/10/2025



Lane Group	SET	NWT	NWR	NEL	NET	NER	SWL	SWT
Lane Group Flow (vph)	20	173	493	14	453	224	499	301
v/c Ratio	0.05	0.57	0.66	0.08	0.74	0.35	0.88	0.26
Control Delay (s/veh)	18.9	43.9	7.9	48.2	42.7	6.1	53.1	13.2
Queue Delay	0.0	0.0	0.0	0.0	0.0	0.0	0.0	0.0
Total Delay (s/veh)	18.9	43.9	7.9	48.2	42.7	6.1	53.1	13.2
Queue Length 50th (ft)	3	97	0	8	254	0	304	68
Queue Length 95th (ft)	10	179	45	30	#444	46	#685	252
Internal Link Dist (ft)	1	409			368			56
Turn Bay Length (ft)			155	35		300		
Base Capacity (vph)	527	405	835	268	665	683	570	1137
Starvation Cap Reductn	0	0	0	0	0	0	0	0
Spillback Cap Reductn	0	0	0	0	0	0	0	0
Storage Cap Reductn	0	0	0	0	0	0	0	0
Reduced v/c Ratio	0.04	0.43	0.59	0.05	0.68	0.33	0.88	0.26

Intersection Summary

95th percentile volume exceeds capacity, queue may be longer.
 Queue shown is maximum after two cycles.

3: Main Street /Dover Road & Newmarket Road/Holiday Inn Express Driveway

01/10/2025

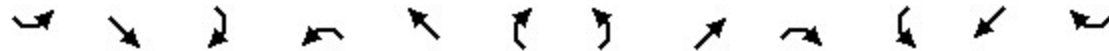

Movement	SEL	SET	SER	NWL	NWT	NWR	NEL	NET	NER	SWL	SWT	SWR
Lane Configurations		↕			↕	↕	↕	↕	↕	↕	↕	↕
Traffic Volume (vph)	1	2	7	140	2	404	12	376	186	469	279	4
Future Volume (vph)	1	2	7	140	2	404	12	376	186	469	279	4
Ideal Flow (vphpl)	1900	1900	1900	1900	1900	1900	1900	1900	1900	1900	1900	1900
Lane Width	12	11	12	12	11	12	11	14	12	12	11	12
Grade (%)		0%			4%			-6%			0%	
Total Lost time (s)		4.0			4.0	4.0	4.0	4.0	4.0	4.0	4.0	
Lane Util. Factor		1.00			1.00	1.00	1.00	1.00	1.00	1.00	1.00	
Frbp, ped/bikes		1.00			1.00	1.00	1.00	1.00	1.00	1.00	1.00	
Flpb, ped/bikes		1.00			1.00	1.00	1.00	1.00	1.00	1.00	1.00	
Frt		0.91			1.00	0.85	1.00	1.00	0.85	1.00	1.00	
Flt Protected		1.00			0.95	1.00	0.95	1.00	1.00	0.95	1.00	
Satd. Flow (prot)		1655			1698	1567	1797	2087	1663	1787	1814	
Flt Permitted		0.98			0.71	1.00	0.95	1.00	1.00	0.95	1.00	
Satd. Flow (perm)		1625			1273	1567	1797	2087	1663	1787	1814	
Peak-hour factor, PHF	0.50	0.50	0.50	0.82	0.82	0.82	0.83	0.83	0.83	0.94	0.94	0.94
Adj. Flow (vph)	2	4	14	171	2	493	14	453	224	499	297	4
RTOR Reduction (vph)	0	11	0	0	0	383	0	0	152	0	0	0
Lane Group Flow (vph)	0	9	0	0	173	110	14	453	72	499	301	0
Confl. Bikes (#/hr)												2
Heavy Vehicles (%)	0%	0%	0%	1%	1%	1%	0%	0%	0%	1%	1%	1%
Turn Type	Perm	NA		Perm	NA	Perm	Prot	NA	Perm	Prot	NA	
Protected Phases		4			8		5	2		1	6	
Permitted Phases	4			8		8			2			
Actuated Green, G (s)		22.3			22.3	22.3	1.6	33.0	33.0	30.6	62.0	
Effective Green, g (s)		24.3			24.3	24.3	3.6	35.0	35.0	32.6	64.0	
Actuated g/C Ratio		0.22			0.22	0.22	0.03	0.32	0.32	0.30	0.59	
Clearance Time (s)		6.0			6.0	6.0	6.0	6.0	6.0	6.0	6.0	
Vehicle Extension (s)		5.0			5.0	5.0	5.0	5.0	5.0	5.0	5.0	
Lane Grp Cap (vph)		363			284	350	59	672	535	536	1069	
v/s Ratio Prot							0.01	c0.22		c0.28	0.17	
v/s Ratio Perm		0.01			c0.14	0.07			0.04			
v/c Ratio		0.03			0.61	0.32	0.24	0.67	0.13	0.93	0.28	

3: Main Street /Dover Road & Newmarket Road/Holiday Inn Express Driveway

01/10/2025



Movement	SEL	SET	SER	NWL	NWT	NWR	NEL	NET	NER	SWL	SWT	SWR	
Uniform Delay, d1		32.9			37.9	35.2	51.2	31.9	26.1	36.9	11.0		
Progression Factor		1.00			1.00	1.00	1.00	1.00	1.00	1.00	1.00		
Incremental Delay, d2		0.1			5.4	1.1	4.3	3.5	0.2	25.1	0.3		
Delay (s)		33.0			43.3	36.3	55.5	35.3	26.3	62.0	11.3		
Level of Service		C			D	D	E	D	C	E	B		
Approach Delay (s/veh)		33.0			38.1			32.8			42.9		
Approach LOS		C			D			C			D		
Intersection Summary													
HCM 2000 Control Delay (s/veh)			38.1		HCM 2000 Level of Service					D			
HCM 2000 Volume to Capacity ratio			0.73										
Actuated Cycle Length (s)			108.6	Sum of lost time (s)						14.0			
Intersection Capacity Utilization			70.3%	ICU Level of Service					C				
Analysis Period (min)			15										

c Critical Lane Group



Movement	NWL	NWR	NET	NER	SWL	SWT
Lane Configurations			↔			↔↔
Traffic Volume (veh/h)	0	0	716	65	3	752
Future Volume (Veh/h)	0	0	716	65	3	752
Sign Control	Stop		Free		Free	
Grade	0%		-3%		3%	
Peak Hour Factor	0.92	0.92	0.83	0.83	0.93	0.93
Hourly flow rate (vph)	0	0	863	78	3	809
Pedestrians	5					
Lane Width (ft)	0.0					
Walking Speed (ft/s)	3.5					
Percent Blockage	0					
Right turn flare (veh)						
Median type	None			None		
Median storage veh						
Upstream signal (ft)	136					
pX, platoon unblocked	0.81	0.81			0.81	
vC, conflicting volume	1318	907			946	
vC1, stage 1 conf vol						
vC2, stage 2 conf vol						
vCu, unblocked vol	1274	766			814	
tC, single (s)	6.8	6.9			4.1	
tC, 2 stage (s)						
tF (s)	3.5	3.3			2.2	
p0 queue free %	100	100			100	
cM capacity (veh/h)	130	283			658	
Direction, Lane #	NE 1	SW 1	SW 2			
Volume Total	941	273	539			
Volume Left	0	3	0			
Volume Right	78	0	0			
cSH	1700	658	1700			
Volume to Capacity	0.55	0.00	0.32			
Queue Length 95th (ft)	0	0	0			
Control Delay (s/veh)	0.0	0.2	0.0			
Lane LOS	A					
Approach Delay (s/veh)	0.0	0.1				
Approach LOS						
Intersection Summary						
Average Delay	0.0					
Intersection Capacity Utilization	45.0%			ICU Level of Service	A	
Analysis Period (min)	15					

2025 Opening Year No-Build Weekday Evening Peak Hour

7: Dover Road & Irving Gas Station Driveway/Holiday Inn Express Driveway 01/10/2025



Movement	SEL	SET	SER	NWL	NWT	NWR	NEL	NET	NER	SWL	SWT	SWR
Lane Configurations		↔			↔	↔		↔			↔	↔
Traffic Volume (veh/h)	0	0	0	31	0	57	0	712	4	20	724	2
Future Volume (Veh/h)	0	0	0	31	0	57	0	712	4	20	724	2
Sign Control		Stop			Stop			Free			Free	
Grade		0%			0%			-3%			3%	
Peak Hour Factor	0.25	0.25	0.25	0.79	0.79	0.79	0.84	0.84	0.84	0.93	0.93	0.93
Hourly flow rate (vph)	0	0	0	39	0	72	0	848	5	22	778	2
Pedestrians		5			12			12			12	
Lane Width (ft)		11.0			10.0			12.0			12.0	
Walking Speed (ft/s)		3.5			3.5			3.5			3.5	
Percent Blockage		0			1			1			1	
Right turn flare (veh)												
Median type								None			None	
Median storage veh												
Upstream signal (ft)								223				
pX, platoon unblocked	0.81	0.81		0.81	0.81	0.81				0.81		
vC, conflicting volume	1763	1693	407	1308	1692	875	785			865		
vC1, stage 1 conf vol												
vC2, stage 2 conf vol												
vCu, unblocked vol	1824	1738	407	1262	1736	728	785			716		
tC, single (s)	7.5	6.5	6.9	7.5	6.5	6.9	4.1			4.1		
tC, 2 stage (s)												
tF (s)	3.5	4.0	3.3	3.5	4.0	3.3	2.2			2.2		
p0 queue free %	100	100	100	60	100	76	100			97		
cM capacity (veh/h)	29	68	590	99	68	294	832			712		
Direction, Lane #	SE 1	NW 1	NW 2	NE 1	SW 1	SW 2						
Volume Total	0	39	72	853	411	391						
Volume Left	0	39	0	0	22	0						
Volume Right	0	0	72	5	0	2						
cSH	1700	99	294	832	712	1700						
Volume to Capacity	0.00	0.40	0.24	0.00	0.03	0.23						
Queue Length 95th (ft)	0	40	24	0	2	0						
Control Delay (s/veh)	0.0	63.6	21.2	0.0	0.9	0.0						
Lane LOS	A	F	C		A							
Approach Delay (s/veh)	0.0	36.1		0.0	0.5							
Approach LOS	A	E										
Intersection Summary												
Average Delay			2.5									
Intersection Capacity Utilization			52.0%		ICU Level of Service				A			
Analysis Period (min)			15									



Movement	SEL	SER	NEL	NET	SWT	SWR
Lane Configurations						
Traffic Volume (veh/h)	0	0	0	769	746	0
Future Volume (Veh/h)	0	0	0	769	746	0
Sign Control	Stop			Free	Free	
Grade	0%			-3%	3%	
Peak Hour Factor	0.25	0.25	0.85	0.85	0.94	0.94
Hourly flow rate (vph)	0	0	0	905	794	0
Pedestrians	7			7	7	
Lane Width (ft)	12.0			11.0	12.0	
Walking Speed (ft/s)	3.5			3.5	3.5	
Percent Blockage	1			1	1	
Right turn flare (veh)						
Median type				None	None	
Median storage (veh)						
Upstream signal (ft)	313					
pX, platoon unblocked	0.81					
vC, conflicting volume	1713	808	801			
vC1, stage 1 conf vol						
vC2, stage 2 conf vol						
vCu, unblocked vol	1763	808	801			
tC, single (s)	6.4	6.2	4.1			
tC, 2 stage (s)						
tF (s)	3.5	3.3	2.2			
p0 queue free %	100	100	100			
cM capacity (veh/h)	75	379	821			
Direction, Lane #	SE 1	NE 1	SW 1			
Volume Total	0	905	794			
Volume Left	0	0	0			
Volume Right	0	0	0			
cSH	1700	821	1700			
Volume to Capacity	0.00	0.00	0.47			
Queue Length 95th (ft)	0	0	0			
Control Delay (s/veh)	0.0	0.0	0.0			
Lane LOS	A					
Approach Delay (s/veh)	0.0	0.0	0.0			
Approach LOS	A					
Intersection Summary						
Average Delay	0.0					
Intersection Capacity Utilization	52.6%			ICU Level of Service	A	
Analysis Period (min)	15					

2025 Opening Year No-Build Saturday Midday Peak Hour



3: Main Street /Dover Road & Newmarket Road/Holiday Inn Express Driveway

01/10/2025



Lane Group	SEL	SET	NWL	NWT	NWR	NEL	NET	NER	SWL	SWT	Ø9
Lane Configurations		↔		↕	↗	↖	↗	↖	↖	↗	
Traffic Volume (vph)	4	2	157	0	377	7	404	243	470	311	
Future Volume (vph)	4	2	157	0	377	7	404	243	470	311	
Turn Type	Perm	NA	Perm	NA	Perm	Prot	NA	Perm	Prot	NA	
Protected Phases		4		8		5	2		1	6	9
Permitted Phases	4		8		8			2			
Detector Phase	4	4	8	8	8	5	2	2	1	6	
Switch Phase											
Minimum Initial (s)	5.0	5.0	5.0	5.0	5.0	5.0	5.0	5.0	5.0	5.0	5.0
Minimum Split (s)	11.0	11.0	11.0	11.0	11.0	16.0	16.0	16.0	16.0	16.0	19.0
Total Split (s)	36.0	36.0	36.0	36.0	36.0	19.0	36.0	36.0	36.0	53.0	19.0
Total Split (%)	28.3%	28.3%	28.3%	28.3%	28.3%	15.0%	28.3%	28.3%	28.3%	41.7%	15%
Yellow Time (s)	4.0	4.0	4.0	4.0	4.0	4.0	4.0	4.0	4.0	4.0	2.0
All-Red Time (s)	2.0	2.0	2.0	2.0	2.0	2.0	2.0	2.0	2.0	2.0	0.0
Lost Time Adjust (s)		-2.0		-2.0	-2.0	-2.0	-2.0	-2.0	-2.0	-2.0	
Total Lost Time (s)		4.0		4.0	4.0	4.0	4.0	4.0	4.0	4.0	
Lead/Lag						Lead	Lag	Lag	Lead	Lag	
Lead-Lag Optimize?						Yes	Yes	Yes	Yes	Yes	
Recall Mode	Min	Min	Min	Min	Min	None	Min	Min	Max	Min	None

Intersection Summary

Cycle Length: 127
 Actuated Cycle Length: 107.3
 Natural Cycle: 90
 Control Type: Semi Act-Uncoord

Splits and Phases: 3: Main Street /Dover Road & Newmarket Road/Holiday Inn Express Driveway

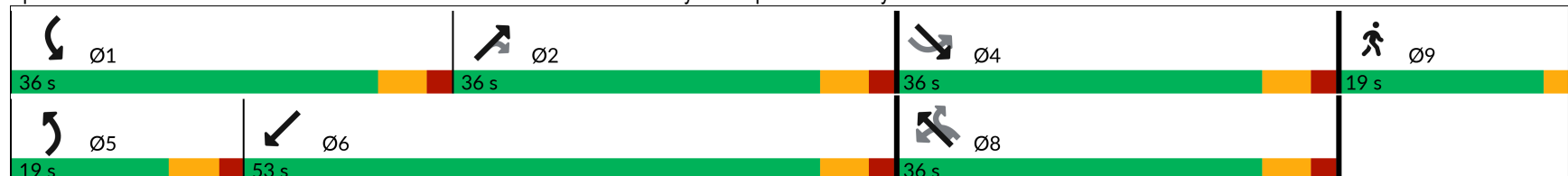

Timings

S:\Jobs\10078 - Durham, NH\Synchro\2025 Opening Year No-Build SAT.syn

3: Main Street /Dover Road & Newmarket Road/Holiday Inn Express Driveway

01/10/2025























Lane Group	SET	NWT	NWR	NEL	NET	NER	SWL	SWT
Lane Group Flow (vph)	24	176	424	8	487	293	547	363
v/c Ratio	0.07	0.60	0.63	0.05	0.80	0.43	1.00	0.33
Control Delay (s/veh)	21.0	47.6	8.1	52.1	48.8	6.4	78.9	15.7
Queue Delay	0.0	0.0	0.0	0.0	0.0	0.0	0.0	0.0
Total Delay (s/veh)	21.0	47.6	8.1	52.1	48.8	6.4	78.9	15.7
Queue Length 50th (ft)	4	99	0	5	275	0	340	82
Queue Length 95th (ft)	19	201	81	21	#519	49	#721	289
Internal Link Dist (ft)	1	409			368			56
Turn Bay Length (ft)			155	35		300		
Base Capacity (vph)	488	399	768	254	631	696	546	1116
Starvation Cap Reductn	0	0	0	0	0	0	0	0
Spillback Cap Reductn	0	0	0	0	0	0	0	0
Storage Cap Reductn	0	0	0	0	0	0	0	0
Reduced v/c Ratio	0.05	0.44	0.55	0.03	0.77	0.42	1.00	0.33

Intersection Summary

95th percentile volume exceeds capacity, queue may be longer.
 Queue shown is maximum after two cycles.

3: Main Street /Dover Road & Newmarket Road/Holiday Inn Express Driveway

01/10/2025

												
Movement	SEL	SET	SER	NWL	NWT	NWR	NEL	NET	NER	SWL	SWT	SWR
Lane Configurations												
Traffic Volume (vph)	4	2	10	157	0	377	7	404	243	470	311	1
Future Volume (vph)	4	2	10	157	0	377	7	404	243	470	311	1
Ideal Flow (vphpl)	1900	1900	1900	1900	1900	1900	1900	1900	1900	1900	1900	1900
Lane Width	12	11	12	12	11	12	11	14	12	12	11	12
Grade (%)		0%			4%			-6%			0%	
Total Lost time (s)		4.0			4.0	4.0	4.0	4.0	4.0	4.0	4.0	
Lane Util. Factor		1.00			1.00	1.00	1.00	1.00	1.00	1.00	1.00	
Frbp, ped/bikes		1.00			1.00	1.00	1.00	1.00	0.98	1.00	1.00	
Flpb, ped/bikes		1.00			1.00	1.00	1.00	1.00	1.00	1.00	1.00	
Frt		0.92			1.00	0.85	1.00	1.00	0.85	1.00	1.00	
Flt Protected		0.99			0.95	1.00	0.95	1.00	1.00	0.95	1.00	
Satd. Flow (prot)		1661			1676	1552	1779	2067	1612	1787	1818	
Flt Permitted		0.93			0.74	1.00	0.95	1.00	1.00	0.95	1.00	
Satd. Flow (perm)		1566			1309	1552	1779	2067	1612	1787	1818	
Peak-hour factor, PHF	0.67	0.67	0.67	0.89	0.89	0.89	0.83	0.83	0.83	0.86	0.86	0.86
Adj. Flow (vph)	6	3	15	176	0	424	8	487	293	547	362	1
RTOR Reduction (vph)	0	12	0	0	0	333	0	0	198	0	0	0
Lane Group Flow (vph)	0	12	0	0	176	91	8	487	95	547	363	0
Confl. Bikes (#/hr)									1			2
Heavy Vehicles (%)	0%	0%	0%	2%	2%	2%	1%	1%	1%	1%	1%	1%
Turn Type	Perm	NA		Perm	NA	Perm	Prot	NA	Perm	Prot	NA	
Protected Phases		4			8		5	2		1	6	
Permitted Phases	4			8		8			2			
Actuated Green, G (s)		22.2			22.2	22.2	1.6	34.7	34.7	30.7	63.8	
Effective Green, g (s)		24.2			24.2	24.2	3.6	36.7	36.7	32.7	65.8	
Actuated g/C Ratio		0.21			0.21	0.21	0.03	0.32	0.32	0.29	0.58	
Clearance Time (s)		6.0			6.0	6.0	6.0	6.0	6.0	6.0	6.0	
Vehicle Extension (s)		5.0			5.0	5.0	5.0	5.0	5.0	5.0	5.0	
Lane Grp Cap (vph)		334			279	331	56	669	522	515	1055	
v/s Ratio Prot							0.00	c0.24		c0.31	0.20	
v/s Ratio Perm		0.01			c0.13	0.06			0.06			
v/c Ratio		0.04			0.63	0.27	0.14	0.73	0.18	1.06	0.34	

3: Main Street /Dover Road & Newmarket Road/Holiday Inn Express Driveway

01/10/2025

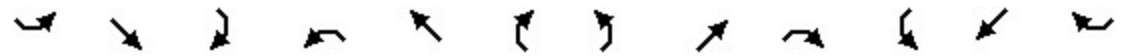

Movement	SEL	SET	SER	NWL	NWT	NWR	NEL	NET	NER	SWL	SWT	SWR
Uniform Delay, d1		35.3			40.5	37.2	53.3	33.9	27.5	40.3	12.4	
Progression Factor		1.00			1.00	1.00	1.00	1.00	1.00	1.00	1.00	
Incremental Delay, d2		0.1			6.3	0.9	2.4	4.8	0.4	57.2	0.4	
Delay (s)		35.4			46.8	38.1	55.8	38.7	27.9	97.5	12.9	
Level of Service		D			D	D	E	D	C	F	B	
Approach Delay (s/veh)		35.4			40.7			34.9			63.7	
Approach LOS		D			D			C			E	

Intersection Summary			
HCM 2000 Control Delay (s/veh)	47.7	HCM 2000 Level of Service	D
HCM 2000 Volume to Capacity ratio	0.77		
Actuated Cycle Length (s)	113.3	Sum of lost time (s)	14.0
Intersection Capacity Utilization	72.7%	ICU Level of Service	C
Analysis Period (min)	15		

c Critical Lane Group



Movement	NWL	NWR	NET	NER	SWL	SWT
Lane Configurations			↔			↔↔
Traffic Volume (veh/h)	0	0	700	85	3	782
Future Volume (Veh/h)	0	0	700	85	3	782
Sign Control	Stop		Free		Free	
Grade	0%		-3%		3%	
Peak Hour Factor	0.92	0.92	0.83	0.83	0.95	0.95
Hourly flow rate (vph)	0	0	843	102	3	823
Pedestrians	2					
Lane Width (ft)	0.0					
Walking Speed (ft/s)	3.5					
Percent Blockage	0					
Right turn flare (veh)						
Median type	None			None		
Median storage veh						
Upstream signal (ft)	136					
pX, platoon unblocked	0.79	0.79			0.79	
vC, conflicting volume	1314	896			947	
vC1, stage 1 conf vol						
vC2, stage 2 conf vol						
vCu, unblocked vol	1263	732			797	
tC, single (s)	6.8	6.9			4.1	
tC, 2 stage (s)						
tF (s)	3.5	3.3			2.2	
p0 queue free %	100	100			100	
cM capacity (veh/h)	129	290			651	
Direction, Lane #	NE 1	SW 1	SW 2			
Volume Total	945	277	549			
Volume Left	0	3	0			
Volume Right	102	0	0			
cSH	1700	651	1700			
Volume to Capacity	0.56	0.00	0.32			
Queue Length 95th (ft)	0	0	0			
Control Delay (s/veh)	0.0	0.2	0.0			
Lane LOS	A					
Approach Delay (s/veh)	0.0	0.1				
Approach LOS						
Intersection Summary						
Average Delay	0.0					
Intersection Capacity Utilization	45.4%		ICU Level of Service		A	
Analysis Period (min)	15					



Movement	SEL	SET	SER	NWL	NWT	NWR	NEL	NET	NER	SWL	SWT	SWR
Lane Configurations		↔			↔	↔		↔			↔↔	
Traffic Volume (veh/h)	1	0	2	48	0	73	0	696	4	25	735	2
Future Volume (Veh/h)	1	0	2	48	0	73	0	696	4	25	735	2
Sign Control		Stop			Stop			Free			Free	
Grade		0%			0%			-3%			3%	
Peak Hour Factor	0.38	0.38	0.38	0.82	0.82	0.82	0.88	0.88	0.88	0.95	0.95	0.95
Hourly flow rate (vph)	3	0	5	59	0	89	0	791	5	26	774	2
Pedestrians		5			2			7			5	
Lane Width (ft)		11.0			10.0			12.0			12.0	
Walking Speed (ft/s)		3.5			3.5			3.5			3.5	
Percent Blockage		0			0			1			0	
Right turn flare (veh)												
Median type								None			None	
Median storage (veh)												
Upstream signal (ft)								223				
pX, platoon unblocked	0.79	0.79		0.79	0.79	0.79				0.79		
vC, conflicting volume	1720	1630	400	1247	1629	801	781			798		
vC1, stage 1 conf vol												
vC2, stage 2 conf vol												
vCu, unblocked vol	1777	1664	400	1180	1662	617	781			614		
tC, single (s)	7.5	6.5	6.9	7.5	6.5	6.9	4.1			4.1		
tC, 2 stage (s)												
tF (s)	3.5	4.0	3.3	3.5	4.0	3.3	2.2			2.2		
p0 queue free %	90	100	99	47	100	74	100			97		
cM capacity (veh/h)	30	74	599	112	75	345	835			766		
Direction, Lane #	SE 1	NW 1	NW 2	NE 1	SW 1	SW 2						
Volume Total	8	59	89	796	413	389						
Volume Left	3	59	0	0	26	0						
Volume Right	5	0	89	5	0	2						
cSH	74	112	345	835	766	1700						
Volume to Capacity	0.11	0.53	0.26	0.00	0.03	0.23						
Queue Length 95th (ft)	9	61	25	0	3	0						
Control Delay (s/veh)	59.4	68.6	19.0	0.0	1.0	0.0						
Lane LOS	F	F	C		A							
Approach Delay (s/veh)	59.4	38.8		0.0	0.5							
Approach LOS	F	E										
Intersection Summary												
Average Delay			3.8									
Intersection Capacity Utilization			57.6%		ICU Level of Service				B			
Analysis Period (min)			15									



Movement	SEL	SER	NEL	NET	SWT	SWR
Lane Configurations						
Traffic Volume (veh/h)	0	0	0	770	762	0
Future Volume (Veh/h)	0	0	0	770	762	0
Sign Control	Stop			Free	Free	
Grade	0%			-3%	3%	
Peak Hour Factor	0.25	0.25	0.88	0.88	0.95	0.95
Hourly flow rate (vph)	0	0	0	875	802	0
Pedestrians						
Lane Width (ft)						
Walking Speed (ft/s)						
Percent Blockage						
Right turn flare (veh)						
Median type				None	None	
Median storage veh						
Upstream signal (ft)				313		
pX, platoon unblocked	0.79					
vC, conflicting volume	1677	802	802			
vC1, stage 1 conf vol						
vC2, stage 2 conf vol						
vCu, unblocked vol	1723	802	802			
tC, single (s)	6.4	6.2	4.1			
tC, 2 stage (s)						
tF (s)	3.5	3.3	2.2			
p0 queue free %	100	100	100			
cM capacity (veh/h)	79	387	826			
Direction, Lane #	SE 1	NE 1	SW 1			
Volume Total	0	875	802			
Volume Left	0	0	0			
Volume Right	0	0	0			
cSH	1700	826	1700			
Volume to Capacity	0.00	0.00	0.47			
Queue Length 95th (ft)	0	0	0			
Control Delay (s/veh)	0.0	0.0	0.0			
Lane LOS	A					
Approach Delay (s/veh)	0.0	0.0	0.0			
Approach LOS	A					
Intersection Summary						
Average Delay				0.0		
Intersection Capacity Utilization				43.9%	ICU Level of Service	A
Analysis Period (min)				15		

2025 Opening Year Build Weekday Morning Peak Hour



3: Main Street /Dover Road & Newmarket Road/Holiday Inn Express Driveway

01/07/2025



Lane Group	SEL	SET	NWL	NWT	NWR	NEL	NET	NER	SWL	SWT	Ø9
Lane Configurations		↔		↕	↗	↖	↗	↖	↖	↗	↖
Traffic Volume (vph)	3	0	156	0	491	2	177	96	409	263	
Future Volume (vph)	3	0	156	0	491	2	177	96	409	263	
Turn Type	Perm	NA	Perm	NA	Perm	Prot	NA	Perm	Prot	NA	
Protected Phases		4		8		5	2		1	6	9
Permitted Phases	4		8		8			2			
Detector Phase	4	4	8	8	8	5	2	2	1	6	
Switch Phase											
Minimum Initial (s)	5.0	5.0	5.0	5.0	5.0	5.0	5.0	5.0	5.0	5.0	5.0
Minimum Split (s)	11.0	11.0	11.0	11.0	11.0	16.0	16.0	16.0	16.0	16.0	20.0
Total Split (s)	36.0	36.0	36.0	36.0	36.0	19.0	36.0	36.0	36.0	53.0	19.0
Total Split (%)	28.3%	28.3%	28.3%	28.3%	28.3%	15.0%	28.3%	28.3%	28.3%	41.7%	15%
Yellow Time (s)	4.0	4.0	4.0	4.0	4.0	4.0	4.0	4.0	4.0	4.0	2.0
All-Red Time (s)	2.0	2.0	2.0	2.0	2.0	2.0	2.0	2.0	2.0	2.0	0.0
Lost Time Adjust (s)		-2.0		-2.0	-2.0	-2.0	-2.0	-2.0	-2.0	-2.0	
Total Lost Time (s)		4.0		4.0	4.0	4.0	4.0	4.0	4.0	4.0	
Lead/Lag						Lead	Lag	Lag	Lead	Lag	
Lead-Lag Optimize?						Yes	Yes	Yes	Yes	Yes	
Recall Mode	Min	Min	Min	Min	Min	None	Min	Min	Max	Min	None

Intersection Summary

Cycle Length: 127
 Actuated Cycle Length: 89.9
 Natural Cycle: 80
 Control Type: Semi Act-Uncoord

Splits and Phases: 3: Main Street /Dover Road & Newmarket Road/Holiday Inn Express Driveway

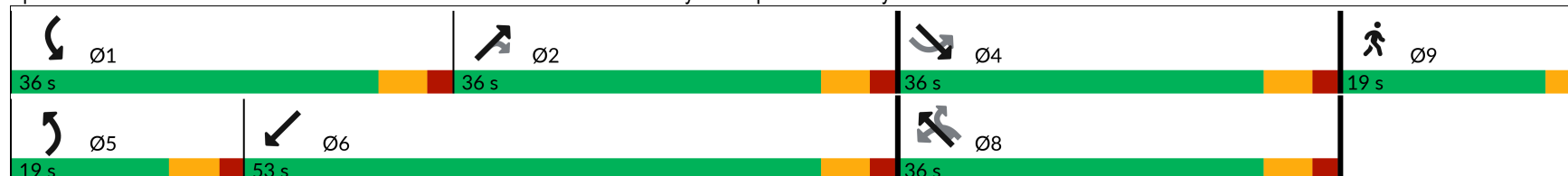

Timings

S:\Jobs\10078 - Durham, NH\Synchro\2025 Opening Year Build AM.syn

3: Main Street /Dover Road & Newmarket Road/Holiday Inn Express Driveway

01/07/2025























Lane Group	SET	NWT	NWR	NEL	NET	NER	SWL	SWT
Lane Group Flow (vph)	6	173	546	2	197	107	454	292
v/c Ratio	0.01	0.51	0.68	0.01	0.48	0.24	0.70	0.27
Control Delay (s/veh)	0.0	36.4	7.7	45.5	37.5	3.8	35.2	13.6
Queue Delay	0.0	0.0	0.0	0.0	0.0	0.0	0.0	0.0
Total Delay (s/veh)	0.0	36.4	7.7	45.5	37.5	3.8	35.2	13.6
Queue Length 50th (ft)	0	77	0	1	92	0	198	60
Queue Length 95th (ft)	0	193	99	11	212	21	#587	245
Internal Link Dist (ft)	1	409			368			56
Turn Bay Length (ft)			155	35		300		
Base Capacity (vph)	659	495	921	295	732	675	645	1067
Starvation Cap Reductn	0	0	0	0	0	0	0	0
Spillback Cap Reductn	0	0	0	0	0	0	0	0
Storage Cap Reductn	0	0	0	0	0	0	0	0
Reduced v/c Ratio	0.01	0.35	0.59	0.01	0.27	0.16	0.70	0.27

Intersection Summary

95th percentile volume exceeds capacity, queue may be longer.
 Queue shown is maximum after two cycles.

3: Main Street /Dover Road & Newmarket Road/Holiday Inn Express Driveway

01/07/2025

												
Movement	SEL	SET	SER	NWL	NWT	NWR	NEL	NET	NER	SWL	SWT	SWR
Lane Configurations												
Traffic Volume (vph)	3	0	3	156	0	491	2	177	96	409	263	0
Future Volume (vph)	3	0	3	156	0	491	2	177	96	409	263	0
Ideal Flow (vphpl)	1900	1900	1900	1900	1900	1900	1900	1900	1900	1900	1900	1900
Lane Width	12	11	12	12	11	12	11	14	12	12	11	12
Grade (%)		0%			4%			-6%			0%	
Total Lost time (s)		4.0			4.0	4.0	4.0	4.0	4.0	4.0	4.0	
Lane Util. Factor		1.00			1.00	1.00	1.00	1.00	1.00	1.00	1.00	
Frbp, ped/bikes		1.00			1.00	1.00	1.00	1.00	1.00	1.00	1.00	
Flpb, ped/bikes		1.00			1.00	1.00	1.00	1.00	1.00	1.00	1.00	
Frt		0.93			1.00	0.85	1.00	1.00	0.85	1.00	1.00	
Flt Protected		0.98			0.95	1.00	0.95	1.00	1.00	0.95	1.00	
Satd. Flow (prot)		1671			1693	1567	1712	1988	1584	1752	1783	
Flt Permitted		0.90			0.75	1.00	0.95	1.00	1.00	0.95	1.00	
Satd. Flow (perm)		1540			1343	1567	1712	1988	1584	1752	1783	
Peak-hour factor, PHF	0.90	0.90	0.90	0.90	0.90	0.90	0.90	0.90	0.90	0.90	0.90	0.90
Adj. Flow (vph)	3	0	3	173	0	546	2	197	107	454	292	0
RTOR Reduction (vph)	0	5	0	0	0	417	0	0	80	0	0	0
Lane Group Flow (vph)	0	1	0	0	173	129	2	197	27	454	292	0
Confl. Bikes (#/hr)												2
Heavy Vehicles (%)	0%	0%	0%	1%	1%	1%	5%	5%	5%	3%	3%	3%
Turn Type	Perm	NA		Perm	NA	Perm	Prot	NA	Perm	Prot	NA	
Protected Phases		4			8		5	2		1	6	
Permitted Phases	4			8		8			2			
Actuated Green, G (s)		20.7			20.7	20.7	1.2	21.9	21.9	31.1	51.8	
Effective Green, g (s)		22.7			22.7	22.7	3.2	23.9	23.9	33.1	53.8	
Actuated g/C Ratio		0.24			0.24	0.24	0.03	0.25	0.25	0.34	0.56	
Clearance Time (s)		6.0			6.0	6.0	6.0	6.0	6.0	6.0	6.0	
Vehicle Extension (s)		5.0			5.0	5.0	5.0	5.0	5.0	5.0	5.0	
Lane Grp Cap (vph)		363			316	369	56	493	393	602	996	
v/s Ratio Prot							0.00	c0.10		c0.26	0.16	
v/s Ratio Perm		0.00			c0.13	0.08			0.02			
v/c Ratio		0.00			0.55	0.35	0.04	0.40	0.07	0.75	0.29	

3: Main Street /Dover Road & Newmarket Road/Holiday Inn Express Driveway

01/07/2025



Movement	SEL	SET	SER	NWL	NWT	NWR	NEL	NET	NER	SWL	SWT	SWR
Uniform Delay, d1		28.2			32.3	30.6	45.1	30.2	27.7	28.0	11.2	
Progression Factor		1.00			1.00	1.00	1.00	1.00	1.00	1.00	1.00	
Incremental Delay, d2		0.0			3.4	1.2	0.5	1.1	0.2	8.5	0.3	
Delay (s)		28.2			35.7	31.8	45.6	31.3	27.8	36.5	11.6	
Level of Service		C			D	C	D	C	C	D	B	
Approach Delay (s/veh)		28.2			32.8			30.2			26.7	
Approach LOS		C			C			C			C	
Intersection Summary												
HCM 2000 Control Delay (s/veh)			29.8		HCM 2000 Level of Service					C		
HCM 2000 Volume to Capacity ratio			0.57									
Actuated Cycle Length (s)			96.3		Sum of lost time (s)				14.0			
Intersection Capacity Utilization			57.2%		ICU Level of Service				B			
Analysis Period (min)			15									

c Critical Lane Group



Movement	NWL	NWR	NET	NER	SWL	SWT
Lane Configurations			↔			↕↕
Traffic Volume (veh/h)	0	0	640	31	5	672
Future Volume (Veh/h)	0	0	640	31	5	672
Sign Control	Stop		Free		Free	
Grade	0%		-3%		3%	
Peak Hour Factor	0.90	0.90	0.90	0.90	0.90	0.90
Hourly flow rate (vph)	0	0	711	34	6	747
Pedestrians						
Lane Width (ft)						
Walking Speed (ft/s)						
Percent Blockage						
Right turn flare (veh)						
Median type	None			None		
Median storage (veh)						
Upstream signal (ft)	136					
pX, platoon unblocked	0.92	0.92			0.92	
vC, conflicting volume	1114	728			745	
vC1, stage 1 conf vol						
vC2, stage 2 conf vol						
vCu, unblocked vol	1078	657			676	
tC, single (s)	6.8	6.9			4.2	
tC, 2 stage (s)						
tF (s)	3.5	3.3			2.2	
p0 queue free %	100	100			99	
cM capacity (veh/h)	197	377			829	
Direction, Lane #	NE 1	SW 1	SW 2			
Volume Total	745	255	498			
Volume Left	0	6	0			
Volume Right	34	0	0			
cSH	1700	829	1700			
Volume to Capacity	0.44	0.01	0.29			
Queue Length 95th (ft)	0	1	0			
Control Delay (s/veh)	0.0	0.3	0.0			
Lane LOS	A					
Approach Delay (s/veh)	0.0	0.1				
Approach LOS						
Intersection Summary						
Average Delay	0.1					
Intersection Capacity Utilization	38.9%		ICU Level of Service		A	
Analysis Period (min)	15					



Movement	SEL	SET	SER	NWL	NWT	NWR	NEL	NET	NER	SWL	SWT	SWR
Lane Configurations		↔			↔	↔		↔			↔	
Traffic Volume (veh/h)	0	0	0	6	0	51	0	637	3	5	671	1
Future Volume (Veh/h)	0	0	0	6	0	51	0	637	3	5	671	1
Sign Control		Stop			Stop			Free			Free	
Grade		0%			0%			-3%			3%	
Peak Hour Factor	0.90	0.90	0.90	0.90	0.90	0.90	0.90	0.90	0.90	0.90	0.90	0.90
Hourly flow rate (vph)	0	0	0	7	0	57	0	708	3	6	746	1
Pedestrians												
Lane Width (ft)												
Walking Speed (ft/s)												
Percent Blockage												
Right turn flare (veh)												
Median type												
								None			None	
Median storage veh												
Upstream signal (ft)												
								223				
pX, platoon unblocked	0.92	0.92		0.92	0.92	0.92					0.92	
vC, conflicting volume	1525	1470	374	1095	1469	710	747				711	
vC1, stage 1 conf vol												
vC2, stage 2 conf vol												
vCu, unblocked vol	1527	1467	374	1058	1466	638	747				640	
tC, single (s)	7.5	6.5	6.9	7.5	6.5	6.9	4.1				4.1	
tC, 2 stage (s)												
tF (s)	3.5	4.0	3.3	3.5	4.0	3.3	2.2				2.2	
p0 queue free %	100	100	100	96	100	85	100				99	
cM capacity (veh/h)	64	118	630	166	118	389	857				863	
Direction, Lane #												
	SE 1	NW 1	NW 2	NE 1	SW 1	SW 2						
Volume Total	0	7	57	711	379	374						
Volume Left	0	7	0	0	6	0						
Volume Right	0	0	57	3	0	1						
cSH	1700	166	389	857	863	1700						
Volume to Capacity	0.00	0.04	0.15	0.00	0.01	0.22						
Queue Length 95th (ft)	0	3	13	0	1	0						
Control Delay (s/veh)	0.0	27.7	15.8	0.0	0.2	0.0						
Lane LOS	A	D	C		A							
Approach Delay (s/veh)	0.0	17.1		0.0	0.1							
Approach LOS	A	C										
Intersection Summary												
Average Delay			0.8									
Intersection Capacity Utilization			43.7%		ICU Level of Service				A			
Analysis Period (min)			15									

10: Dover Road & Site Driveway

01/07/2025



Movement	SEL	SER	NEL	NET	SWT	SWR
Lane Configurations						
Traffic Volume (veh/h)	53	47	49	639	630	34
Future Volume (Veh/h)	53	47	49	639	630	34
Sign Control	Stop			Free	Free	
Grade	0%			-3%	3%	
Peak Hour Factor	0.90	0.90	0.90	0.90	0.90	0.90
Hourly flow rate (vph)	59	52	54	710	700	38
Pedestrians						
Lane Width (ft)						
Walking Speed (ft/s)						
Percent Blockage						
Right turn flare (veh)						
Median type				None	None	
Median storage veh						
Upstream signal (ft)	313					
pX, platoon unblocked	0.92					
vC, conflicting volume	1537	719	738			
vC1, stage 1 conf vol						
vC2, stage 2 conf vol						
vCu, unblocked vol	1540	719	738			
tC, single (s)	6.4	6.2	4.1			
tC, 2 stage (s)						
tF (s)	3.5	3.3	2.2			
p0 queue free %	47	88	94			
cM capacity (veh/h)	111	432	868			
Direction, Lane #	SE 1	NE 1	SW 1			
Volume Total	111	764	738			
Volume Left	59	54	0			
Volume Right	52	0	38			
cSH	170	868	1700			
Volume to Capacity	0.65	0.06	0.43			
Queue Length 95th (ft)	94	5	0			
Control Delay (s/veh)	59.3	1.6	0.0			
Lane LOS	F	A				
Approach Delay (s/veh)	59.3	1.6	0.0			
Approach LOS	F					
Intersection Summary						
Average Delay	4.8					
Intersection Capacity Utilization	86.5%			ICU Level of Service	E	
Analysis Period (min)	15					

2025 Opening Year Build Weekday Evening Peak Hour



3: Main Street /Dover Road & Newmarket Road/Holiday Inn Express Driveway

01/07/2025



Lane Group	SEL	SET	NWL	NWT	NWR	NEL	NET	NER	SWL	SWT	Ø9
Lane Configurations		↔		↕	↕	↕	↕	↕	↕	↕	
Traffic Volume (vph)	1	2	140	2	406	12	376	186	472	280	
Future Volume (vph)	1	2	140	2	406	12	376	186	472	280	
Turn Type	Perm	NA	Perm	NA	Perm	Prot	NA	Perm	Prot	NA	
Protected Phases		4		8		5	2		1	6	9
Permitted Phases	4		8		8			2			
Detector Phase	4	4	8	8	8	5	2	2	1	6	
Switch Phase											
Minimum Initial (s)	5.0	5.0	5.0	5.0	5.0	5.0	5.0	5.0	5.0	5.0	5.0
Minimum Split (s)	11.0	11.0	11.0	11.0	11.0	16.0	16.0	16.0	16.0	16.0	19.0
Total Split (s)	36.0	36.0	36.0	36.0	36.0	19.0	36.0	36.0	36.0	53.0	19.0
Total Split (%)	28.3%	28.3%	28.3%	28.3%	28.3%	15.0%	28.3%	28.3%	28.3%	41.7%	15%
Yellow Time (s)	4.0	4.0	4.0	4.0	4.0	4.0	4.0	4.0	4.0	4.0	2.0
All-Red Time (s)	2.0	2.0	2.0	2.0	2.0	2.0	2.0	2.0	2.0	2.0	0.0
Lost Time Adjust (s)		-2.0		-2.0	-2.0	-2.0	-2.0	-2.0	-2.0	-2.0	
Total Lost Time (s)		4.0		4.0	4.0	4.0	4.0	4.0	4.0	4.0	
Lead/Lag						Lead	Lag	Lag	Lead	Lag	
Lead-Lag Optimize?						Yes	Yes	Yes	Yes	Yes	
Recall Mode	Min	Min	Min	Min	Min	None	Min	Min	Max	Min	None

Intersection Summary

Cycle Length: 127
 Actuated Cycle Length: 98.7
 Natural Cycle: 90
 Control Type: Semi Act-Uncoord

Splits and Phases: 3: Main Street /Dover Road & Newmarket Road/Holiday Inn Express Driveway

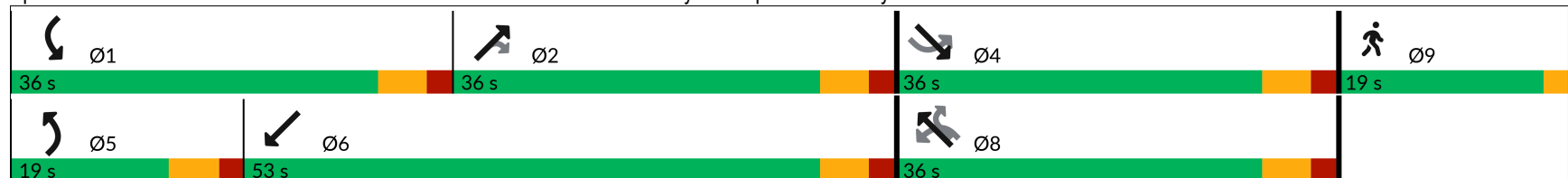

Timings

S:\Jobs\10078 - Durham, NH\Synchro\2025 Opening Year Build PM.syn

3: Main Street /Dover Road & Newmarket Road/Holiday Inn Express Driveway

01/07/2025























Lane Group	SET	NWT	NWR	NEL	NET	NER	SWL	SWT
Lane Group Flow (vph)	11	158	451	13	418	207	524	315
v/c Ratio	0.03	0.54	0.64	0.07	0.70	0.33	0.88	0.27
Control Delay (s/veh)	21.2	42.6	8.0	47.7	40.8	6.3	51.9	13.0
Queue Delay	0.0	0.0	0.0	0.0	0.0	0.0	0.0	0.0
Total Delay (s/veh)	21.2	42.6	8.0	47.7	40.8	6.3	51.9	13.0
Queue Length 50th (ft)	1	86	0	7	221	0	306	66
Queue Length 95th (ft)	18	183	89	32	#468	61	#730	264
Internal Link Dist (ft)	1	409			368			56
Turn Bay Length (ft)			155	35		300		
Base Capacity (vph)	546	427	822	280	694	691	594	1149
Starvation Cap Reductn	0	0	0	0	0	0	0	0
Spillback Cap Reductn	0	0	0	0	0	0	0	0
Storage Cap Reductn	0	0	0	0	0	0	0	0
Reduced v/c Ratio	0.02	0.37	0.55	0.05	0.60	0.30	0.88	0.27

Intersection Summary

95th percentile volume exceeds capacity, queue may be longer.
 Queue shown is maximum after two cycles.

3: Main Street /Dover Road & Newmarket Road/Holiday Inn Express Driveway

01/07/2025

												
Movement	SEL	SET	SER	NWL	NWT	NWR	NEL	NET	NER	SWL	SWT	SWR
Lane Configurations												
Traffic Volume (vph)	1	2	7	140	2	406	12	376	186	472	280	4
Future Volume (vph)	1	2	7	140	2	406	12	376	186	472	280	4
Ideal Flow (vphpl)	1900	1900	1900	1900	1900	1900	1900	1900	1900	1900	1900	1900
Lane Width	12	11	12	12	11	12	11	14	12	12	11	12
Grade (%)		0%			4%			-6%			0%	
Total Lost time (s)		4.0			4.0	4.0	4.0	4.0	4.0	4.0	4.0	
Lane Util. Factor		1.00			1.00	1.00	1.00	1.00	1.00	1.00	1.00	
Frbp, ped/bikes		1.00			1.00	1.00	1.00	1.00	1.00	1.00	1.00	
Flpb, ped/bikes		1.00			1.00	1.00	1.00	1.00	1.00	1.00	1.00	
Frt		0.90			1.00	0.85	1.00	1.00	0.85	1.00	1.00	
Flt Protected		1.00			0.95	1.00	0.95	1.00	1.00	0.95	1.00	
Satd. Flow (prot)		1649			1698	1567	1797	2087	1663	1787	1815	
Flt Permitted		0.98			0.72	1.00	0.95	1.00	1.00	0.95	1.00	
Satd. Flow (perm)		1625			1285	1567	1797	2087	1663	1787	1815	
Peak-hour factor, PHF	0.90	0.90	0.90	0.90	0.90	0.90	0.90	0.90	0.90	0.90	0.90	0.90
Adj. Flow (vph)	1	2	8	156	2	451	13	418	207	524	311	4
RTOR Reduction (vph)	0	6	0	0	0	355	0	0	141	0	0	0
Lane Group Flow (vph)	0	5	0	0	158	96	13	418	66	524	315	0
Confl. Bikes (#/hr)												2
Heavy Vehicles (%)	0%	0%	0%	1%	1%	1%	0%	0%	0%	1%	1%	1%
Turn Type	Perm	NA		Perm	NA	Perm	Prot	NA	Perm	Prot	NA	
Protected Phases		4			8		5	2		1	6	
Permitted Phases	4			8		8			2			
Actuated Green, G (s)		20.5			20.5	20.5	1.6	31.3	31.3	30.8	60.5	
Effective Green, g (s)		22.5			22.5	22.5	3.6	33.3	33.3	32.8	62.5	
Actuated g/C Ratio		0.21			0.21	0.21	0.03	0.32	0.32	0.31	0.59	
Clearance Time (s)		6.0			6.0	6.0	6.0	6.0	6.0	6.0	6.0	
Vehicle Extension (s)		5.0			5.0	5.0	5.0	5.0	5.0	5.0	5.0	
Lane Grp Cap (vph)		347			274	335	61	660	526	557	1078	
v/s Ratio Prot							0.01	c0.20		c0.29	0.17	
v/s Ratio Perm		0.00			c0.12	0.06			0.04			
v/c Ratio		0.01			0.58	0.29	0.21	0.63	0.12	0.94	0.29	

3: Main Street /Dover Road & Newmarket Road/Holiday Inn Express Driveway

01/07/2025



Movement	SEL	SET	SER	NWL	NWT	NWR	NEL	NET	NER	SWL	SWT	SWR
Uniform Delay, d1		32.6			37.1	34.6	49.4	30.7	25.6	35.3	10.5	
Progression Factor		1.00			1.00	1.00	1.00	1.00	1.00	1.00	1.00	
Incremental Delay, d2		0.0			4.6	1.0	3.6	2.8	0.2	26.0	0.3	
Delay (s)		32.6			41.7	35.6	53.1	33.5	25.8	61.2	10.8	
Level of Service		C			D	D	D	C	C	E	B	
Approach Delay (s/veh)		32.6			37.2			31.4			42.3	
Approach LOS		C			D			C			D	

Intersection Summary		
HCM 2000 Control Delay (s/veh)	37.5	HCM 2000 Level of Service D
HCM 2000 Volume to Capacity ratio	0.71	
Actuated Cycle Length (s)	105.2	Sum of lost time (s) 14.0
Intersection Capacity Utilization	70.5%	ICU Level of Service C
Analysis Period (min)	15	

c Critical Lane Group



Movement	NWL	NWR	NET	NER	SWL	SWT
Lane Configurations			↔			↔↔
Traffic Volume (veh/h)	0	0	723	59	3	756
Future Volume (Veh/h)	0	0	723	59	3	756
Sign Control	Stop		Free		Free	
Grade	0%		-3%		3%	
Peak Hour Factor	0.90	0.90	0.90	0.90	0.90	0.90
Hourly flow rate (vph)	0	0	803	66	3	840
Pedestrians	5					
Lane Width (ft)	0.0					
Walking Speed (ft/s)	3.5					
Percent Blockage	0					
Right turn flare (veh)						
Median type	None			None		
Median storage veh						
Upstream signal (ft)	136					
pX, platoon unblocked	0.82	0.82			0.82	
vC, conflicting volume	1267	841			874	
vC1, stage 1 conf vol						
vC2, stage 2 conf vol						
vCu, unblocked vol	1217	701			741	
tC, single (s)	6.8	6.9			4.1	
tC, 2 stage (s)						
tF (s)	3.5	3.3			2.2	
p0 queue free %	100	100			100	
cM capacity (veh/h)	144	318			716	
Direction, Lane #	NE 1	SW 1	SW 2			
Volume Total	869	283	560			
Volume Left	0	3	0			
Volume Right	66	0	0			
cSH	1700	716	1700			
Volume to Capacity	0.51	0.00	0.33			
Queue Length 95th (ft)	0	0	0			
Control Delay (s/veh)	0.0	0.2	0.0			
Lane LOS	A					
Approach Delay (s/veh)	0.0	0.1				
Approach LOS						
Intersection Summary						
Average Delay	0.0					
Intersection Capacity Utilization	45.0%			ICU Level of Service	A	
Analysis Period (min)	15					



Movement	SEL	SET	SER	NWL	NWT	NWR	NEL	NET	NER	SWL	SWT	SWR
Lane Configurations		↕↔			↕	↗		↕↔			↕↔	
Traffic Volume (veh/h)	0	0	0	20	0	49	0	719	4	9	739	2
Future Volume (Veh/h)	0	0	0	20	0	49	0	719	4	9	739	2
Sign Control		Stop			Stop			Free			Free	
Grade		0%			0%			-3%			3%	
Peak Hour Factor	0.90	0.90	0.90	0.90	0.90	0.90	0.90	0.90	0.90	0.90	0.90	0.90
Hourly flow rate (vph)	0	0	0	22	0	54	0	799	4	10	821	2
Pedestrians		5			12			12			12	
Lane Width (ft)		11.0			10.0			12.0			12.0	
Walking Speed (ft/s)		3.5			3.5			3.5			3.5	
Percent Blockage		0			1			1			1	
Right turn flare (veh)												
Median type								None			None	
Median storage (veh)												
Upstream signal (ft)								223				
pX, platoon unblocked	0.83	0.83		0.83	0.83	0.83				0.83		
vC, conflicting volume	1714	1662	429	1256	1661	825	828			815		
vC1, stage 1 conf vol												
vC2, stage 2 conf vol												
vCu, unblocked vol	1759	1696	429	1204	1695	683	828			671		
tC, single (s)	7.5	6.5	6.9	7.5	6.5	6.9	4.1			4.1		
tC, 2 stage (s)												
tF (s)	3.5	4.0	3.3	3.5	4.0	3.3	2.2			2.2		
p0 queue free %	100	100	100	80	100	83	100			99		
cM capacity (veh/h)	36	75	571	113	75	321	802			755		
Direction, Lane #	SE 1	NW 1	NW 2	NE 1	SW 1	SW 2						
Volume Total	0	22	54	803	421	413						
Volume Left	0	22	0	0	10	0						
Volume Right	0	0	54	4	0	2						
cSH	1700	113	321	802	755	1700						
Volume to Capacity	0.00	0.20	0.17	0.00	0.01	0.24						
Queue Length 95th (ft)	0	17	15	0	1	0						
Control Delay (s/veh)	0.0	44.6	18.5	0.0	0.4	0.0						
Lane LOS	A	E	C		A							
Approach Delay (s/veh)	0.0	26.0		0.0	0.2							
Approach LOS	A	D										
Intersection Summary												
Average Delay			1.3									
Intersection Capacity Utilization			52.0%		ICU Level of Service				A			
Analysis Period (min)			15									

10: Dover Road & Site Driveway

01/07/2025



Movement	SEL	SER	NEL	NET	SWT	SWR
Lane Configurations						
Traffic Volume (veh/h)	22	18	20	748	732	15
Future Volume (Veh/h)	22	18	20	748	732	15
Sign Control	Stop			Free	Free	
Grade	0%			-3%	3%	
Peak Hour Factor	0.90	0.90	0.90	0.90	0.90	0.90
Hourly flow rate (vph)	24	20	22	831	813	17
Pedestrians	7			7	7	
Lane Width (ft)	12.0			11.0	12.0	
Walking Speed (ft/s)	3.5			3.5	3.5	
Percent Blockage	1			1	1	
Right turn flare (veh)						
Median type				None	None	
Median storage veh						
Upstream signal (ft)				313		
pX, platoon unblocked	0.83					
vC, conflicting volume	1711	836	837			
vC1, stage 1 conf vol						
vC2, stage 2 conf vol						
vCu, unblocked vol	1755	836	837			
tC, single (s)	6.4	6.2	4.1			
tC, 2 stage (s)						
tF (s)	3.5	3.3	2.2			
p0 queue free %	68	95	97			
cM capacity (veh/h)	75	366	796			
Direction, Lane #	SE 1	NE 1	SW 1			
Volume Total	44	853	830			
Volume Left	24	22	0			
Volume Right	20	0	17			
cSH	117	796	1700			
Volume to Capacity	0.37	0.03	0.49			
Queue Length 95th (ft)	39	2	0			
Control Delay (s/veh)	53.0	0.8	0.0			
Lane LOS	F	A				
Approach Delay (s/veh)	53.0	0.8	0.0			
Approach LOS	F					
Intersection Summary						
Average Delay			1.7			
Intersection Capacity Utilization			67.5%	ICU Level of Service	C	
Analysis Period (min)			15			

2025 Opening Year Build Saturday Midday Peak Hour



3: Main Street /Dover Road & Newmarket Road/Holiday Inn Express Driveway

01/07/2025



Lane Group	SEL	SET	NWL	NWT	NWR	NEL	NET	NER	SWL	SWT	Ø9
Lane Configurations		↔		↕	↗	↘	↖	↗	↘	↖	↗
Traffic Volume (vph)	4	2	157	0	381	7	405	243	474	312	
Future Volume (vph)	4	2	157	0	381	7	405	243	474	312	
Turn Type	Perm	NA	Perm	NA	Perm	Prot	NA	Perm	Prot	NA	
Protected Phases		4		8		5	2		1	6	9
Permitted Phases	4		8		8			2			
Detector Phase	4	4	8	8	8	5	2	2	1	6	
Switch Phase											
Minimum Initial (s)	5.0	5.0	5.0	5.0	5.0	5.0	5.0	5.0	5.0	5.0	5.0
Minimum Split (s)	11.0	11.0	11.0	11.0	11.0	16.0	16.0	16.0	16.0	16.0	19.0
Total Split (s)	36.0	36.0	36.0	36.0	36.0	19.0	36.0	36.0	36.0	53.0	19.0
Total Split (%)	28.3%	28.3%	28.3%	28.3%	28.3%	15.0%	28.3%	28.3%	28.3%	41.7%	15%
Yellow Time (s)	4.0	4.0	4.0	4.0	4.0	4.0	4.0	4.0	4.0	4.0	2.0
All-Red Time (s)	2.0	2.0	2.0	2.0	2.0	2.0	2.0	2.0	2.0	2.0	0.0
Lost Time Adjust (s)		-2.0		-2.0	-2.0	-2.0	-2.0	-2.0	-2.0	-2.0	
Total Lost Time (s)		4.0		4.0	4.0	4.0	4.0	4.0	4.0	4.0	
Lead/Lag						Lead	Lag	Lag	Lead	Lag	
Lead-Lag Optimize?						Yes	Yes	Yes	Yes	Yes	
Recall Mode	Min	Min	Min	Min	Min	None	Min	Min	Max	Min	None

Intersection Summary

Cycle Length: 127
 Actuated Cycle Length: 105.7
 Natural Cycle: 90
 Control Type: Semi Act-Uncoord

Splits and Phases: 3: Main Street /Dover Road & Newmarket Road/Holiday Inn Express Driveway

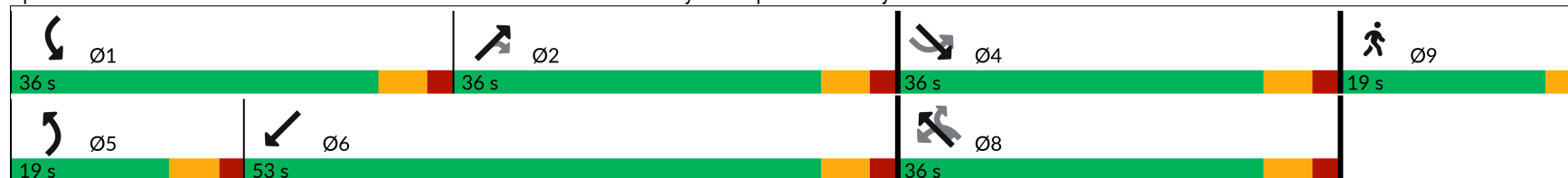

Timings

S:\Jobs\10078 - Durham, NH\Synchro\2025 Opening Year Build SAT.syn

3: Main Street /Dover Road & Newmarket Road/Holiday Inn Express Driveway

01/07/2025























Lane Group	SET	NWT	NWR	NEL	NET	NER	SWL	SWT
Lane Group Flow (vph)	17	174	423	8	450	270	527	348
v/c Ratio	0.05	0.58	0.62	0.05	0.77	0.41	0.95	0.31
Control Delay (s/veh)	21.9	46.7	8.1	52.0	46.8	6.5	66.0	15.5
Queue Delay	0.0	0.0	0.0	0.0	0.0	0.0	0.0	0.0
Total Delay (s/veh)	21.9	46.7	8.1	52.0	46.8	6.5	66.0	15.5
Queue Length 50th (ft)	3	97	0	5	247	0	321	77
Queue Length 95th (ft)	23	201	87	23	#533	68	#735	292
Internal Link Dist (ft)	1	409			368			56
Turn Bay Length (ft)			155	35		300		
Base Capacity (vph)	499	409	774	259	644	688	557	1111
Starvation Cap Reductn	0	0	0	0	0	0	0	0
Spillback Cap Reductn	0	0	0	0	0	0	0	0
Storage Cap Reductn	0	0	0	0	0	0	0	0
Reduced v/c Ratio	0.03	0.43	0.55	0.03	0.70	0.39	0.95	0.31

Intersection Summary

95th percentile volume exceeds capacity, queue may be longer.
 Queue shown is maximum after two cycles.

3: Main Street /Dover Road & Newmarket Road/Holiday Inn Express Driveway

01/07/2025

												
Movement	SEL	SET	SER	NWL	NWT	NWR	NEL	NET	NER	SWL	SWT	SWR
Lane Configurations												
Traffic Volume (vph)	4	2	10	157	0	381	7	405	243	474	312	1
Future Volume (vph)	4	2	10	157	0	381	7	405	243	474	312	1
Ideal Flow (vphpl)	1900	1900	1900	1900	1900	1900	1900	1900	1900	1900	1900	1900
Lane Width	12	11	12	12	11	12	11	14	12	12	11	12
Grade (%)		0%			4%			-6%			0%	
Total Lost time (s)		4.0			4.0	4.0	4.0	4.0	4.0	4.0	4.0	
Lane Util. Factor		1.00			1.00	1.00	1.00	1.00	1.00	1.00	1.00	
Frbp, ped/bikes		1.00			1.00	1.00	1.00	1.00	0.98	1.00	1.00	
Flpb, ped/bikes		1.00			1.00	1.00	1.00	1.00	1.00	1.00	1.00	
Frt		0.91			1.00	0.85	1.00	1.00	0.85	1.00	1.00	
Flt Protected		0.99			0.95	1.00	0.95	1.00	1.00	0.95	1.00	
Satd. Flow (prot)		1657			1676	1552	1779	2067	1612	1787	1818	
Flt Permitted		0.94			0.75	1.00	0.95	1.00	1.00	0.95	1.00	
Satd. Flow (perm)		1578			1317	1552	1779	2067	1612	1787	1818	
Peak-hour factor, PHF	0.90	0.90	0.90	0.90	0.90	0.90	0.90	0.90	0.90	0.90	0.90	0.90
Adj. Flow (vph)	4	2	11	174	0	423	8	450	270	527	347	1
RTOR Reduction (vph)	0	9	0	0	0	332	0	0	185	0	0	0
Lane Group Flow (vph)	0	8	0	0	174	91	8	450	85	527	348	0
Confl. Bikes (#/hr)									1			2
Heavy Vehicles (%)	0%	0%	0%	2%	2%	2%	1%	1%	1%	1%	1%	1%
Turn Type	Perm	NA		Perm	NA	Perm	Prot	NA	Perm	Prot	NA	
Protected Phases		4			8		5	2		1	6	
Permitted Phases	4			8		8			2			
Actuated Green, G (s)		21.9			21.9	21.9	1.5	33.2	33.2	30.9	62.6	
Effective Green, g (s)		23.9			23.9	23.9	3.5	35.2	35.2	32.9	64.6	
Actuated g/C Ratio		0.21			0.21	0.21	0.03	0.32	0.32	0.29	0.58	
Clearance Time (s)		6.0			6.0	6.0	6.0	6.0	6.0	6.0	6.0	
Vehicle Extension (s)		5.0			5.0	5.0	5.0	5.0	5.0	5.0	5.0	
Lane Grp Cap (vph)		337			281	332	55	651	507	526	1051	
v/s Ratio Prot							0.00	c0.22		c0.29	0.19	
v/s Ratio Perm		0.01			c0.13	0.06			0.05			
v/c Ratio		0.02			0.62	0.27	0.15	0.69	0.17	1.00	0.33	

3: Main Street /Dover Road & Newmarket Road/Holiday Inn Express Driveway

01/07/2025



Movement	SEL	SET	SER	NWL	NWT	NWR	NEL	NET	NER	SWL	SWT	SWR
Uniform Delay, d1		34.7			39.8	36.6	52.6	33.5	27.7	39.4	12.3	
Progression Factor		1.00			1.00	1.00	1.00	1.00	1.00	1.00	1.00	
Incremental Delay, d2		0.1			5.8	0.9	2.5	4.0	0.3	39.7	0.4	
Delay (s)		34.8			45.5	37.6	55.2	37.5	28.0	79.1	12.7	
Level of Service		C			D	D	E	D	C	E	B	
Approach Delay (s/veh)		34.8			39.9			34.2			52.7	
Approach LOS		C			D			C			D	

Intersection Summary			
HCM 2000 Control Delay (s/veh)	43.0	HCM 2000 Level of Service	D
HCM 2000 Volume to Capacity ratio	0.74		
Actuated Cycle Length (s)	111.7	Sum of lost time (s)	14.0
Intersection Capacity Utilization	72.9%	ICU Level of Service	C
Analysis Period (min)	15		

c Critical Lane Group



Movement	NWL	NWR	NET	NER	SWL	SWT
Lane Configurations			↔			↔↔
Traffic Volume (veh/h)	0	0	715	75	3	787
Future Volume (Veh/h)	0	0	715	75	3	787
Sign Control	Stop		Free		Free	
Grade	0%		-3%		3%	
Peak Hour Factor	0.90	0.90	0.90	0.90	0.90	0.90
Hourly flow rate (vph)	0	0	794	83	3	874
Pedestrians	2					
Lane Width (ft)	0.0					
Walking Speed (ft/s)	3.5					
Percent Blockage	0					
Right turn flare (veh)						
Median type	None			None		
Median storage veh						
Upstream signal (ft)	136					
pX, platoon unblocked	0.81	0.81			0.81	
vC, conflicting volume	1281	838			879	
vC1, stage 1 conf vol						
vC2, stage 2 conf vol						
vCu, unblocked vol	1227	677			729	
tC, single (s)	6.8	6.9			4.1	
tC, 2 stage (s)						
tF (s)	3.5	3.3			2.2	
p0 queue free %	100	100			100	
cM capacity (veh/h)	139	322			706	
Direction, Lane #	NE 1	SW 1	SW 2			
Volume Total	877	294	583			
Volume Left	0	3	0			
Volume Right	83	0	0			
cSH	1700	706	1700			
Volume to Capacity	0.52	0.00	0.34			
Queue Length 95th (ft)	0	0	0			
Control Delay (s/veh)	0.0	0.2	0.0			
Lane LOS	A					
Approach Delay (s/veh)	0.0	0.1				
Approach LOS						
Intersection Summary						
Average Delay	0.0					
Intersection Capacity Utilization	45.5%		ICU Level of Service		A	
Analysis Period (min)	15					



Movement	SEL	SET	SER	NWL	NWT	NWR	NEL	NET	NER	SWL	SWT	SWR
Lane Configurations		↕			↕	↕		↕			↕	↕
Traffic Volume (veh/h)	1	0	2	33	0	61	0	711	4	9	755	2
Future Volume (Veh/h)	1	0	2	33	0	61	0	711	4	9	755	2
Sign Control		Stop			Stop			Free			Free	
Grade		0%			0%			-3%			3%	
Peak Hour Factor	0.90	0.90	0.90	0.90	0.90	0.90	0.90	0.90	0.90	0.90	0.90	0.90
Hourly flow rate (vph)	1	0	2	37	0	68	0	790	4	10	839	2
Pedestrians		5			2			7			5	
Lane Width (ft)		11.0			10.0			12.0			12.0	
Walking Speed (ft/s)		3.5			3.5			3.5			3.5	
Percent Blockage		0			0			1			0	
Right turn flare (veh)												
Median type								None			None	
Median storage veh												
Upstream signal (ft)								223				
pX, platoon unblocked	0.81	0.81		0.81	0.81	0.81				0.81		
vC, conflicting volume	1730	1661	433	1243	1660	799	846			796		
vC1, stage 1 conf vol												
vC2, stage 2 conf vol												
vCu, unblocked vol	1785	1699	433	1181	1698	632	846			628		
tC, single (s)	7.5	6.5	6.9	7.5	6.5	6.9	4.1			4.1		
tC, 2 stage (s)												
tF (s)	3.5	4.0	3.3	3.5	4.0	3.3	2.2			2.2		
p0 queue free %	97	100	100	68	100	80	100			99		
cM capacity (veh/h)	33	74	570	116	74	344	790			771		
Direction, Lane #	SE 1	NW 1	NW 2	NE 1	SW 1	SW 2						
Volume Total	3	37	68	794	430	422						
Volume Left	1	37	0	0	10	0						
Volume Right	2	0	68	4	0	2						
cSH	89	116	344	790	771	1700						
Volume to Capacity	0.03	0.32	0.20	0.00	0.01	0.25						
Queue Length 95th (ft)	3	31	18	0	1	0						
Control Delay (s/veh)	46.7	49.9	18.0	0.0	0.4	0.0						
Lane LOS	E	E	C		A							
Approach Delay (s/veh)	46.7	29.3		0.0	0.2							
Approach LOS	E	D										
Intersection Summary												
Average Delay			1.9									
Intersection Capacity Utilization			57.7%		ICU Level of Service				B			
Analysis Period (min)			15									

10: Dover Road & Site Driveway

01/07/2025



Movement	SEL	SER	NEL	NET	SWT	SWR
Lane Configurations						
Traffic Volume (veh/h)	31	25	33	740	741	22
Future Volume (Veh/h)	31	25	33	740	741	22
Sign Control	Stop			Free	Free	
Grade	0%			-3%	3%	
Peak Hour Factor	0.90	0.90	0.90	0.90	0.90	0.90
Hourly flow rate (vph)	34	28	37	822	823	24
Pedestrians						
Lane Width (ft)						
Walking Speed (ft/s)						
Percent Blockage						
Right turn flare (veh)						
Median type				None	None	
Median storage veh						
Upstream signal (ft)	313					
pX, platoon unblocked	0.81					
vC, conflicting volume	1731	835	847			
vC1, stage 1 conf vol						
vC2, stage 2 conf vol						
vCu, unblocked vol	1786	835	847			
tC, single (s)	6.4	6.2	4.1			
tC, 2 stage (s)						
tF (s)	3.5	3.3	2.2			
p0 queue free %	51	92	95			
cM capacity (veh/h)	70	371	795			
Direction, Lane #	SE 1	NE 1	SW 1			
Volume Total	62	859	847			
Volume Left	34	37	0			
Volume Right	28	0	24			
cSH	110	795	1700			
Volume to Capacity	0.56	0.05	0.50			
Queue Length 95th (ft)	67	4	0			
Control Delay (s/veh)	73.5	1.3	0.0			
Lane LOS	F	A				
Approach Delay (s/veh)	73.5	1.3	0.0			
Approach LOS	F					
Intersection Summary						
Average Delay			3.2			
Intersection Capacity Utilization			75.8%	ICU Level of Service	D	
Analysis Period (min)			15			

2025 Opening Year Build Mitigated Weekday Morning Peak Hour





Movement	SEL	SER	NEL	NET	SWT	SWR
Lane Configurations						
Traffic Volume (veh/h)	53	47	49	639	630	34
Future Volume (Veh/h)	53	47	49	639	630	34
Sign Control	Stop			Free	Free	
Grade	0%			-3%	3%	
Peak Hour Factor	0.90	0.90	0.90	0.90	0.90	0.90
Hourly flow rate (vph)	59	52	54	710	700	38
Pedestrians						
Lane Width (ft)						
Walking Speed (ft/s)						
Percent Blockage						
Right turn flare (veh)						
Median type				None	None	
Median storage (veh)						
Upstream signal (ft)	313					
pX, platoon unblocked	0.92					
vC, conflicting volume	1537	719	738			
vC1, stage 1 conf vol						
vC2, stage 2 conf vol						
vCu, unblocked vol	1540	719	738			
tC, single (s)	6.4	6.2	4.1			
tC, 2 stage (s)						
tF (s)	3.5	3.3	2.2			
p0 queue free %	47	88	94			
cM capacity (veh/h)	111	432	868			
Direction, Lane #	SE 1	NE 1	NE 2	SW 1		
Volume Total	111	54	710	738		
Volume Left	59	54	0	0		
Volume Right	52	0	0	38		
cSH	170	868	1700	1700		
Volume to Capacity	0.65	0.06	0.42	0.43		
Queue Length 95th (ft)	93	5	0	0		
Control Delay (s/veh)	58.8	9.4	0.0	0.0		
Lane LOS	F	A				
Approach Delay (s/veh)	58.8	0.7		0.0		
Approach LOS	F					
Intersection Summary						
Average Delay	4.4					
Intersection Capacity Utilization	53.2%			ICU Level of Service	A	
Analysis Period (min)	15					

2025 Opening Year Build Mitigated Weekday Evening Peak Hour





Movement	SEL	SER	NEL	NET	SWT	SWR
Lane Configurations						
Traffic Volume (veh/h)	22	18	20	748	732	15
Future Volume (Veh/h)	22	18	20	748	732	15
Sign Control	Stop			Free	Free	
Grade	0%			-3%	3%	
Peak Hour Factor	0.90	0.90	0.90	0.90	0.90	0.90
Hourly flow rate (vph)	24	20	22	831	813	17
Pedestrians	7			7	7	
Lane Width (ft)	12.0			11.5	12.0	
Walking Speed (ft/s)	3.5			3.5	3.5	
Percent Blockage	1			1	1	
Right turn flare (veh)						
Median type				None	None	
Median storage (veh)						
Upstream signal (ft)				313		
pX, platoon unblocked	0.83					
vC, conflicting volume	1711	836	837			
vC1, stage 1 conf vol						
vC2, stage 2 conf vol						
vCu, unblocked vol	1755	836	837			
tC, single (s)	6.4	6.2	4.1			
tC, 2 stage (s)						
tF (s)	3.5	3.3	2.2			
p0 queue free %	68	95	97			
cM capacity (veh/h)	75	366	796			
Direction, Lane #	SE 1	NE 1	NE 2	SW 1		
Volume Total	44	22	831	830		
Volume Left	24	22	0	0		
Volume Right	20	0	0	17		
cSH	118	796	1700	1700		
Volume to Capacity	0.37	0.03	0.49	0.49		
Queue Length 95th (ft)	38	2	0	0		
Control Delay (s/veh)	52.9	9.7	0.0	0.0		
Lane LOS	F	A				
Approach Delay (s/veh)	52.9	0.2		0.0		
Approach LOS	F					
Intersection Summary						
Average Delay			1.5			
Intersection Capacity Utilization			51.5%	ICU Level of Service	A	
Analysis Period (min)			15			

2025 Opening Year Build Mitigated Saturday Midday Peak Hour





Movement	SEL	SER	NEL	NET	SWT	SWR
Lane Configurations						
Traffic Volume (veh/h)	31	25	33	740	741	22
Future Volume (Veh/h)	31	25	33	740	741	22
Sign Control	Stop			Free	Free	
Grade	0%			-3%	3%	
Peak Hour Factor	0.90	0.90	0.90	0.90	0.90	0.90
Hourly flow rate (vph)	34	28	37	822	823	24
Pedestrians						
Lane Width (ft)						
Walking Speed (ft/s)						
Percent Blockage						
Right turn flare (veh)						
Median type				None	None	
Median storage veh						
Upstream signal (ft)	313					
pX, platoon unblocked	0.81					
vC, conflicting volume	1731	835	847			
vC1, stage 1 conf vol						
vC2, stage 2 conf vol						
vCu, unblocked vol	1785	835	847			
tC, single (s)	6.4	6.2	4.1			
tC, 2 stage (s)						
tF (s)	3.5	3.3	2.2			
p0 queue free %	51	92	95			
cM capacity (veh/h)	70	371	795			
Direction, Lane #	SE 1	NE 1	NE 2	SW 1		
Volume Total	62	37	822	847		
Volume Left	34	37	0	0		
Volume Right	28	0	0	24		
cSH	110	795	1700	1700		
Volume to Capacity	0.56	0.05	0.48	0.50		
Queue Length 95th (ft)	67	4	0	0		
Control Delay (s/veh)	73.0	9.8	0.0	0.0		
Lane LOS	F	A				
Approach Delay (s/veh)	73.0	0.4	0.0			
Approach LOS	F					
Intersection Summary						
Average Delay	2.8					
Intersection Capacity Utilization	50.3%			ICU Level of Service	A	
Analysis Period (min)	15					

2035 Design Year No-Build Weekday Morning Peak Hour



3: Main Street /Dover Road & Newmarket Road/Holiday Inn Express Driveway

01/07/2025



Lane Group	SEL	SET	NWL	NWT	NWR	NEL	NET	NER	SWL	SWT	Ø9
Lane Configurations		↔		↕	↗	↘	↕	↗	↘	↕	
Traffic Volume (vph)	4	2	173	0	420	7	447	269	523	345	
Future Volume (vph)	4	2	173	0	420	7	447	269	523	345	
Turn Type	Perm	NA	Perm	NA	Perm	Prot	NA	Perm	Prot	NA	
Protected Phases		4		8		5	2		1	6	9
Permitted Phases	4		8		8			2			
Detector Phase	4	4	8	8	8	5	2	2	1	6	
Switch Phase											
Minimum Initial (s)	5.0	5.0	5.0	5.0	5.0	5.0	5.0	5.0	5.0	5.0	5.0
Minimum Split (s)	11.0	11.0	11.0	11.0	11.0	16.0	16.0	16.0	16.0	16.0	19.0
Total Split (s)	36.0	36.0	36.0	36.0	36.0	19.0	36.0	36.0	36.0	53.0	19.0
Total Split (%)	28.3%	28.3%	28.3%	28.3%	28.3%	15.0%	28.3%	28.3%	28.3%	41.7%	15%
Yellow Time (s)	4.0	4.0	4.0	4.0	4.0	4.0	4.0	4.0	4.0	4.0	2.0
All-Red Time (s)	2.0	2.0	2.0	2.0	2.0	2.0	2.0	2.0	2.0	2.0	0.0
Lost Time Adjust (s)		-2.0		-2.0	-2.0	-2.0	-2.0	-2.0	-2.0	-2.0	
Total Lost Time (s)		4.0		4.0	4.0	4.0	4.0	4.0	4.0	4.0	
Lead/Lag						Lead	Lag	Lag	Lead	Lag	
Lead-Lag Optimize?						Yes	Yes	Yes	Yes	Yes	
Recall Mode	Min	Min	Min	Min	Min	None	Min	Min	Max	Min	None

Intersection Summary

Cycle Length: 127
 Actuated Cycle Length: 108.7
 Natural Cycle: 100
 Control Type: Semi Act-Uncoord

Splits and Phases: 3: Main Street /Dover Road & Newmarket Road/Holiday Inn Express Driveway

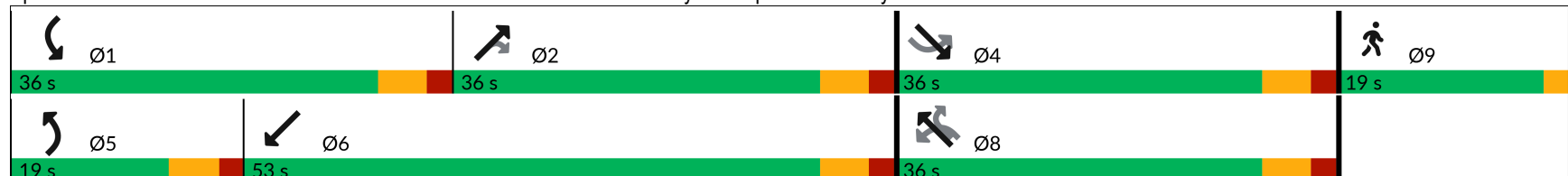

Timings

S:\Jobs\10078 - Durham, NH\Synchro\2035 Design Year Build SAT.syn

3: Main Street /Dover Road & Newmarket Road/Holiday Inn Express Driveway

01/07/2025



Lane Group	SET	NWT	NWR	NEL	NET	NER	SWL	SWT
Lane Group Flow (vph)	17	192	467	8	497	299	581	384
v/c Ratio	0.05	0.63	0.65	0.05	0.82	0.44	1.08	0.35
Control Delay (s/veh)	21.9	48.6	8.1	52.3	50.4	6.6	101.6	16.2
Queue Delay	0.0	0.0	0.0	0.0	0.0	0.0	0.0	0.0
Total Delay (s/veh)	21.9	48.6	8.1	52.3	50.4	6.6	101.6	16.2
Queue Length 50th (ft)	3	109	0	5	288	1	~404	92
Queue Length 95th (ft)	23	222	92	23	#620	74	#834	327
Internal Link Dist (ft)	1	409			368			56
Turn Bay Length (ft)			155	35		300		
Base Capacity (vph)	480	394	792	250	620	690	536	1104
Starvation Cap Reductn	0	0	0	0	0	0	0	0
Spillback Cap Reductn	0	0	0	0	0	0	0	0
Storage Cap Reductn	0	0	0	0	0	0	0	0
Reduced v/c Ratio	0.04	0.49	0.59	0.03	0.80	0.43	1.08	0.35

Intersection Summary

~ Volume exceeds capacity, queue is theoretically infinite.

Queue shown is maximum after two cycles.

95th percentile volume exceeds capacity, queue may be longer.

Queue shown is maximum after two cycles.

3: Main Street /Dover Road & Newmarket Road/Holiday Inn Express Driveway

01/07/2025



Movement	SEL	SET	SER	NWL	NWT	NWR	NEL	NET	NER	SWL	SWT	SWR
Lane Configurations		↔			↔	↔	↔	↔	↔	↔	↔	↔
Traffic Volume (vph)	4	2	10	173	0	420	7	447	269	523	345	1
Future Volume (vph)	4	2	10	173	0	420	7	447	269	523	345	1
Ideal Flow (vphpl)	1900	1900	1900	1900	1900	1900	1900	1900	1900	1900	1900	1900
Lane Width	12	11	12	12	11	12	11	14	12	12	11	12
Grade (%)		0%			4%			-6%			0%	
Total Lost time (s)		4.0			4.0	4.0	4.0	4.0	4.0	4.0	4.0	
Lane Util. Factor		1.00			1.00	1.00	1.00	1.00	1.00	1.00	1.00	
Frbp, ped/bikes		1.00			1.00	1.00	1.00	1.00	0.98	1.00	1.00	
Flpb, ped/bikes		1.00			1.00	1.00	1.00	1.00	1.00	1.00	1.00	
Frt		0.91			1.00	0.85	1.00	1.00	0.85	1.00	1.00	
Flt Protected		0.99			0.95	1.00	0.95	1.00	1.00	0.95	1.00	
Satd. Flow (prot)		1657			1676	1552	1779	2067	1612	1787	1818	
Flt Permitted		0.94			0.75	1.00	0.95	1.00	1.00	0.95	1.00	
Satd. Flow (perm)		1576			1317	1552	1779	2067	1612	1787	1818	
Peak-hour factor, PHF	0.90	0.90	0.90	0.90	0.90	0.90	0.90	0.90	0.90	0.90	0.90	0.90
Adj. Flow (vph)	4	2	11	192	0	467	8	497	299	581	383	1
RTOR Reduction (vph)	0	9	0	0	0	364	0	0	201	0	0	0
Lane Group Flow (vph)	0	8	0	0	192	103	8	497	98	581	384	0
Confl. Bikes (#/hr)									1			2
Heavy Vehicles (%)	0%	0%	0%	2%	2%	2%	1%	1%	1%	1%	1%	1%
Turn Type	Perm	NA		Perm	NA	Perm	Prot	NA	Perm	Prot	NA	
Protected Phases		4			8		5	2		1	6	
Permitted Phases	4			8		8			2			
Actuated Green, G (s)		23.3			23.3	23.3	1.6	35.0	35.0	30.6	64.0	
Effective Green, g (s)		25.3			25.3	25.3	3.6	37.0	37.0	32.6	66.0	
Actuated g/C Ratio		0.22			0.22	0.22	0.03	0.32	0.32	0.28	0.58	
Clearance Time (s)		6.0			6.0	6.0	6.0	6.0	6.0	6.0	6.0	
Vehicle Extension (s)		5.0			5.0	5.0	5.0	5.0	5.0	5.0	5.0	
Lane Grp Cap (vph)		347			290	342	55	666	520	507	1046	
v/s Ratio Prot							0.00	c0.24		c0.33	0.21	
v/s Ratio Perm		0.01			c0.15	0.07			0.06			
v/c Ratio		0.02			0.66	0.30	0.15	0.75	0.19	1.15	0.37	

3: Main Street /Dover Road & Newmarket Road/Holiday Inn Express Driveway

01/07/2025

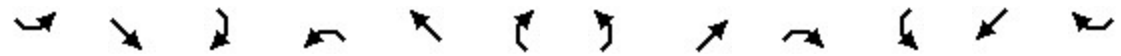

Movement	SEL	SET	SER	NWL	NWT	NWR	NEL	NET	NER	SWL	SWT	SWR
Uniform Delay, d1		35.0			40.8	37.3	54.1	34.7	28.0	41.1	13.1	
Progression Factor		1.00			1.00	1.00	1.00	1.00	1.00	1.00	1.00	
Incremental Delay, d2		0.1			7.3	1.0	2.5	5.5	0.4	86.8	0.5	
Delay (s)		35.1			48.1	38.4	56.6	40.1	28.4	127.8	13.6	
Level of Service		D			D	D	E	D	C	F	B	
Approach Delay (s/veh)		35.1			41.2			35.9			82.4	
Approach LOS		D			D			D			F	

Intersection Summary		
HCM 2000 Control Delay (s/veh)	55.7	HCM 2000 Level of Service E
HCM 2000 Volume to Capacity ratio	0.81	
Actuated Cycle Length (s)	114.7	Sum of lost time (s) 14.0
Intersection Capacity Utilization	78.8%	ICU Level of Service D
Analysis Period (min)	15	

c Critical Lane Group

5: Dover Road & Irving Gas Station Driveway

01/07/2025



Movement	NWL	NWR	NET	NER	SWL	SWT
Lane Configurations			↔			↕↕
Traffic Volume (veh/h)	0	0	796	75	3	869
Future Volume (Veh/h)	0	0	796	75	3	869
Sign Control	Stop		Free		Free	
Grade	0%		-3%		3%	
Peak Hour Factor	0.90	0.90	0.90	0.90	0.90	0.90
Hourly flow rate (vph)	0	0	884	83	3	966
Pedestrians	2					
Lane Width (ft)	0.0					
Walking Speed (ft/s)	3.5					
Percent Blockage	0					
Right turn flare (veh)						
Median type	None			None		
Median storage veh						
Upstream signal (ft)	136					
pX, platoon unblocked	0.78	0.78			0.78	
vC, conflicting volume	1417	928			969	
vC1, stage 1 conf vol						
vC2, stage 2 conf vol						
vCu, unblocked vol	1393	767			820	
tC, single (s)	6.8	6.9			4.1	
tC, 2 stage (s)						
tF (s)	3.5	3.3			2.2	
p0 queue free %	100	100			100	
cM capacity (veh/h)	105	273			633	
Direction, Lane #	NE 1	SW 1	SW 2			
Volume Total	967	325	644			
Volume Left	0	3	0			
Volume Right	83	0	0			
cSH	1700	633	1700			
Volume to Capacity	0.57	0.00	0.38			
Queue Length 95th (ft)	0	0	0			
Control Delay (s/veh)	0.0	0.2	0.0			
Lane LOS	A					
Approach Delay (s/veh)	0.0	0.1				
Approach LOS						
Intersection Summary						
Average Delay	0.0					
Intersection Capacity Utilization	49.8%		ICU Level of Service	A		
Analysis Period (min)	15					



Movement	SEL	SET	SER	NWL	NWT	NWR	NEL	NET	NER	SWL	SWT	SWR
Lane Configurations		↕			↕	↕		↕			↕	↕
Traffic Volume (veh/h)	1	0	2	33	0	61	0	792	4	9	837	2
Future Volume (Veh/h)	1	0	2	33	0	61	0	792	4	9	837	2
Sign Control		Stop			Stop			Free			Free	
Grade		0%			0%			-3%			3%	
Peak Hour Factor	0.90	0.90	0.90	0.90	0.90	0.90	0.90	0.90	0.90	0.90	0.90	0.90
Hourly flow rate (vph)	1	0	2	37	0	68	0	880	4	10	930	2
Pedestrians		5			2			7			5	
Lane Width (ft)		11.0			10.0			12.0			12.0	
Walking Speed (ft/s)		3.5			3.5			3.5			3.5	
Percent Blockage		0			0			1			0	
Right turn flare (veh)												
Median type								None			None	
Median storage veh												
Upstream signal (ft)								223				
pX, platoon unblocked	0.78	0.78		0.78	0.78	0.78				0.78		
vC, conflicting volume	1911	1842	478	1378	1841	889	937			886		
vC1, stage 1 conf vol												
vC2, stage 2 conf vol												
vCu, unblocked vol	2025	1937	478	1344	1936	719	937			715		
tC, single (s)	7.5	6.5	6.9	7.5	6.5	6.9	4.1			4.1		
tC, 2 stage (s)												
tF (s)	3.5	4.0	3.3	3.5	4.0	3.3	2.2			2.2		
p0 queue free %	95	100	100	57	100	77	100			99		
cM capacity (veh/h)	20	51	533	85	51	292	730			693		
Direction, Lane #	SE 1	NW 1	NW 2	NE 1	SW 1	SW 2						
Volume Total	3	37	68	884	475	467						
Volume Left	1	37	0	0	10	0						
Volume Right	2	0	68	4	0	2						
cSH	57	85	292	730	693	1700						
Volume to Capacity	0.05	0.43	0.23	0.00	0.01	0.27						
Queue Length 95th (ft)	4	44	22	0	1	0						
Control Delay (s/veh)	72.2	76.2	21.0	0.0	0.4	0.0						
Lane LOS	F	F	C		A							
Approach Delay (s/veh)	72.2	40.5		0.0	0.2							
Approach LOS	F	E										
Intersection Summary												
Average Delay			2.4									
Intersection Capacity Utilization			61.9%		ICU Level of Service				B			
Analysis Period (min)			15									

10: Dover Road & Site Driveway



Movement	SEL	SER	NEL	NET	SWT	SWR
Lane Configurations						
Traffic Volume (veh/h)	31	25	33	821	823	22
Future Volume (Veh/h)	31	25	33	821	823	22
Sign Control	Stop			Free	Free	
Grade	0%			-3%	3%	
Peak Hour Factor	0.90	0.90	0.90	0.90	0.90	0.90
Hourly flow rate (vph)	34	28	37	912	914	24
Pedestrians						
Lane Width (ft)						
Walking Speed (ft/s)						
Percent Blockage						
Right turn flare (veh)						
Median type				None	None	
Median storage veh						
Upstream signal (ft)	313					
pX, platoon unblocked	0.78					
vC, conflicting volume	1912	926	938			
vC1, stage 1 conf vol						
vC2, stage 2 conf vol						
vCu, unblocked vol	2027	926	938			
tC, single (s)	6.4	6.2	4.1			
tC, 2 stage (s)						
tF (s)	3.5	3.3	2.2			
p0 queue free %	29	91	95			
cM capacity (veh/h)	48	329	735			
Direction, Lane #	SE 1	NE 1	SW 1			
Volume Total	62	949	938			
Volume Left	34	37	0			
Volume Right	28	0	24			
cSH	78	735	1700			
Volume to Capacity	0.80	0.05	0.55			
Queue Length 95th (ft)	99	4	0			
Control Delay (s/veh)	143.3	1.5	0.0			
Lane LOS	F	A				
Approach Delay (s/veh)	143.3	1.5	0.0			
Approach LOS	F					
Intersection Summary						
Average Delay			5.3			
Intersection Capacity Utilization			80.0%	ICU Level of Service	D	
Analysis Period (min)			15			

2035 Design Year No-Build Weekday Evening Peak Hour



3: Main Street /Dover Road & Newmarket Road/Holiday Inn Express Driveway

01/07/2025



Lane Group	SEL	SET	NWL	NWT	NWR	NEL	NET	NER	SWL	SWT	Ø9
Lane Configurations		↔		↕	↕	↕	↕	↕	↕	↕	
Traffic Volume (vph)	1	2	155	2	446	12	415	205	518	308	
Future Volume (vph)	1	2	155	2	446	12	415	205	518	308	
Turn Type	Perm	NA	Perm	NA	Perm	Prot	NA	Perm	Prot	NA	
Protected Phases		4		8		5	2		1	6	9
Permitted Phases	4		8		8			2			
Detector Phase	4	4	8	8	8	5	2	2	1	6	
Switch Phase											
Minimum Initial (s)	5.0	5.0	5.0	5.0	5.0	5.0	5.0	5.0	5.0	5.0	5.0
Minimum Split (s)	11.0	11.0	11.0	11.0	11.0	16.0	16.0	16.0	16.0	16.0	19.0
Total Split (s)	36.0	36.0	36.0	36.0	36.0	19.0	36.0	36.0	36.0	53.0	19.0
Total Split (%)	28.3%	28.3%	28.3%	28.3%	28.3%	15.0%	28.3%	28.3%	28.3%	41.7%	15%
Yellow Time (s)	4.0	4.0	4.0	4.0	4.0	4.0	4.0	4.0	4.0	4.0	2.0
All-Red Time (s)	2.0	2.0	2.0	2.0	2.0	2.0	2.0	2.0	2.0	2.0	0.0
Lost Time Adjust (s)		-2.0		-2.0	-2.0	-2.0	-2.0	-2.0	-2.0	-2.0	
Total Lost Time (s)		4.0		4.0	4.0	4.0	4.0	4.0	4.0	4.0	
Lead/Lag						Lead	Lag	Lag	Lead	Lag	
Lead-Lag Optimize?						Yes	Yes	Yes	Yes	Yes	
Recall Mode	Min	Min	Min	Min	Min	None	Min	Min	Max	Min	None

Intersection Summary

Cycle Length: 127
 Actuated Cycle Length: 102.7
 Natural Cycle: 90
 Control Type: Semi Act-Uncoord

Splits and Phases: 3: Main Street /Dover Road & Newmarket Road/Holiday Inn Express Driveway

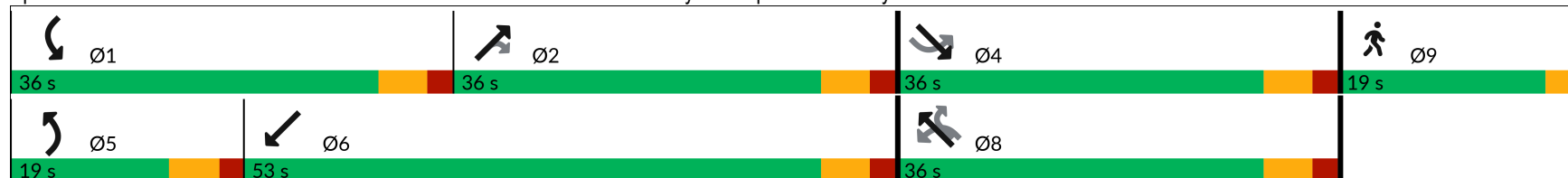

Timings

S:\Jobs\10078 - Durham, NH\Synchro\2035 Design Year No-Build PM.syn

3: Main Street /Dover Road & Newmarket Road/Holiday Inn Express Driveway

01/07/2025



Lane Group	SET	NWT	NWR	NEL	NET	NER	SWL	SWT
Lane Group Flow (vph)	11	174	496	13	461	228	576	346
v/c Ratio	0.03	0.57	0.66	0.07	0.75	0.35	1.02	0.30
Control Delay (s/veh)	21.1	43.7	7.9	48.4	43.2	6.1	79.2	13.7
Queue Delay	0.0	0.0	0.0	0.0	0.0	0.0	0.0	0.0
Total Delay (s/veh)	21.1	43.7	7.9	48.4	43.2	6.1	79.2	13.7
Queue Length 50th (ft)	2	98	0	8	260	0	~384	81
Queue Length 95th (ft)	18	203	95	32	#549	63	#824	293
Internal Link Dist (ft)	1	409			368			56
Turn Bay Length (ft)			155	35		300		
Base Capacity (vph)	521	407	836	267	662	683	567	1138
Starvation Cap Reductn	0	0	0	0	0	0	0	0
Spillback Cap Reductn	0	0	0	0	0	0	0	0
Storage Cap Reductn	0	0	0	0	0	0	0	0
Reduced v/c Ratio	0.02	0.43	0.59	0.05	0.70	0.33	1.02	0.30

Intersection Summary

~ Volume exceeds capacity, queue is theoretically infinite.

Queue shown is maximum after two cycles.

95th percentile volume exceeds capacity, queue may be longer.

Queue shown is maximum after two cycles.

3: Main Street /Dover Road & Newmarket Road/Holiday Inn Express Driveway

01/07/2025



Movement	SEL	SET	SER	NWL	NWT	NWR	NEL	NET	NER	SWL	SWT	SWR
Lane Configurations		↔			↕	↗	↖	↘	↙	↕	↗	↖
Traffic Volume (vph)	1	2	7	155	2	446	12	415	205	518	308	4
Future Volume (vph)	1	2	7	155	2	446	12	415	205	518	308	4
Ideal Flow (vphpl)	1900	1900	1900	1900	1900	1900	1900	1900	1900	1900	1900	1900
Lane Width	12	11	12	12	11	12	11	14	12	12	11	12
Grade (%)		0%			4%			-6%			0%	
Total Lost time (s)		4.0			4.0	4.0	4.0	4.0	4.0	4.0	4.0	
Lane Util. Factor		1.00			1.00	1.00	1.00	1.00	1.00	1.00	1.00	
Frbp, ped/bikes		1.00			1.00	1.00	1.00	1.00	1.00	1.00	1.00	
Flpb, ped/bikes		1.00			1.00	1.00	1.00	1.00	1.00	1.00	1.00	
Frt		0.90			1.00	0.85	1.00	1.00	0.85	1.00	1.00	
Flt Protected		1.00			0.95	1.00	0.95	1.00	1.00	0.95	1.00	
Satd. Flow (prot)		1649			1698	1567	1797	2087	1663	1787	1815	
Flt Permitted		0.98			0.72	1.00	0.95	1.00	1.00	0.95	1.00	
Satd. Flow (perm)		1626			1285	1567	1797	2087	1663	1787	1815	
Peak-hour factor, PHF	0.90	0.90	0.90	0.90	0.90	0.90	0.90	0.90	0.90	0.90	0.90	0.90
Adj. Flow (vph)	1	2	8	172	2	496	13	461	228	576	342	4
RTOR Reduction (vph)	0	6	0	0	0	385	0	0	154	0	0	0
Lane Group Flow (vph)	0	5	0	0	174	111	13	461	74	576	346	0
Confl. Bikes (#/hr)												2
Heavy Vehicles (%)	0%	0%	0%	1%	1%	1%	0%	0%	0%	1%	1%	1%
Turn Type	Perm	NA		Perm	NA	Perm	Prot	NA	Perm	Prot	NA	
Protected Phases		4			8		5	2		1	6	
Permitted Phases	4			8		8			2			
Actuated Green, G (s)		22.4			22.4	22.4	1.6	33.4	33.4	30.5	62.3	
Effective Green, g (s)		24.4			24.4	24.4	3.6	35.4	35.4	32.5	64.3	
Actuated g/C Ratio		0.22			0.22	0.22	0.03	0.32	0.32	0.30	0.59	
Clearance Time (s)		6.0			6.0	6.0	6.0	6.0	6.0	6.0	6.0	
Vehicle Extension (s)		5.0			5.0	5.0	5.0	5.0	5.0	5.0	5.0	
Lane Grp Cap (vph)		363			287	350	59	677	540	532	1070	
v/s Ratio Prot							0.01	c0.22		c0.32	0.19	
v/s Ratio Perm		0.00			c0.14	0.07			0.04			
v/c Ratio		0.01			0.61	0.32	0.22	0.68	0.14	1.08	0.32	

3: Main Street /Dover Road & Newmarket Road/Holiday Inn Express Driveway

01/07/2025



Movement	SEL	SET	SER	NWL	NWT	NWR	NEL	NET	NER	SWL	SWT	SWR
Uniform Delay, d1		32.9			38.0	35.3	51.3	31.9	26.0	38.3	11.3	
Progression Factor		1.00			1.00	1.00	1.00	1.00	1.00	1.00	1.00	
Incremental Delay, d2		0.0			5.3	1.1	3.9	3.6	0.2	63.3	0.4	
Delay (s)		33.0			43.2	36.4	55.3	35.5	26.3	101.5	11.7	
Level of Service		C			D	D	E	D	C	F	B	
Approach Delay (s/veh)		33.0			38.2			32.9			67.8	
Approach LOS		C			D			C			E	

Intersection Summary		
HCM 2000 Control Delay (s/veh)	48.4	HCM 2000 Level of Service D
HCM 2000 Volume to Capacity ratio	0.78	
Actuated Cycle Length (s)	109.0	Sum of lost time (s) 14.0
Intersection Capacity Utilization	75.9%	ICU Level of Service D
Analysis Period (min)	15	

c Critical Lane Group



Movement	NWL	NWR	NET	NER	SWL	SWT
Lane Configurations			↔			↔↔
Traffic Volume (veh/h)	0	0	797	65	3	830
Future Volume (Veh/h)	0	0	797	65	3	830
Sign Control	Stop		Free		Free	
Grade	0%		-3%		3%	
Peak Hour Factor	0.90	0.90	0.90	0.90	0.90	0.90
Hourly flow rate (vph)	0	0	886	72	3	922
Pedestrians	5					
Lane Width (ft)	0.0					
Walking Speed (ft/s)	3.5					
Percent Blockage	0					
Right turn flare (veh)						
Median type	None			None		
Median storage veh						
Upstream signal (ft)	136					
pX, platoon unblocked	0.80	0.80			0.80	
vC, conflicting volume	1394	927			963	
vC1, stage 1 conf vol						
vC2, stage 2 conf vol						
vCu, unblocked vol	1368	787			832	
tC, single (s)	6.8	6.9			4.1	
tC, 2 stage (s)						
tF (s)	3.5	3.3			2.2	
p0 queue free %	100	100			100	
cM capacity (veh/h)	112	272			645	
Direction, Lane #	NE 1	SW 1	SW 2			
Volume Total	958	310	615			
Volume Left	0	3	0			
Volume Right	72	0	0			
cSH	1700	645	1700			
Volume to Capacity	0.56	0.00	0.36			
Queue Length 95th (ft)	0	0	0			
Control Delay (s/veh)	0.0	0.2	0.0			
Lane LOS	A					
Approach Delay (s/veh)	0.0	0.1				
Approach LOS						
Intersection Summary						
Average Delay	0.0					
Intersection Capacity Utilization	49.3%			ICU Level of Service	A	
Analysis Period (min)	15					



Movement	SEL	SET	SER	NWL	NWT	NWR	NEL	NET	NER	SWL	SWT	SWR
Lane Configurations		↔			↔	↔		↔			↔	
Traffic Volume (veh/h)	0	0	0	31	0	57	0	793	4	20	802	2
Future Volume (Veh/h)	0	0	0	31	0	57	0	793	4	20	802	2
Sign Control		Stop			Stop			Free			Free	
Grade		0%			0%			-3%			3%	
Peak Hour Factor	0.90	0.90	0.90	0.90	0.90	0.90	0.90	0.90	0.90	0.90	0.90	0.90
Hourly flow rate (vph)	0	0	0	34	0	63	0	881	4	22	891	2
Pedestrians		5			12			12			12	
Lane Width (ft)		11.0			10.0			12.0			12.0	
Walking Speed (ft/s)		3.5			3.5			3.5			3.5	
Percent Blockage		0			1			1			1	
Right turn flare (veh)												
Median type								None			None	
Median storage veh												
Upstream signal (ft)								223				
pX, platoon unblocked	0.81	0.81		0.81	0.81	0.81				0.81		
vC, conflicting volume	1899	1838	464	1397	1837	907	898			897		
vC1, stage 1 conf vol												
vC2, stage 2 conf vol												
vCu, unblocked vol	1996	1920	464	1371	1919	763	898			751		
tC, single (s)	7.5	6.5	6.9	7.5	6.5	6.9	4.1			4.1		
tC, 2 stage (s)												
tF (s)	3.5	4.0	3.3	3.5	4.0	3.3	2.2			2.2		
p0 queue free %	100	100	100	58	100	77	100			97		
cM capacity (veh/h)	22	52	542	81	52	277	755			686		
Direction, Lane #	SE 1	NW 1	NW 2	NE 1	SW 1	SW 2						
Volume Total	0	34	63	885	468	448						
Volume Left	0	34	0	0	22	0						
Volume Right	0	0	63	4	0	2						
cSH	1700	81	277	755	686	1700						
Volume to Capacity	0.00	0.42	0.23	0.00	0.03	0.26						
Queue Length 95th (ft)	0	42	21	0	2	0						
Control Delay (s/veh)	0.0	77.8	21.8	0.0	0.9	0.0						
Lane LOS	A	F	C		A							
Approach Delay (s/veh)	0.0	41.4		0.0	0.5							
Approach LOS	A	E										
Intersection Summary												
Average Delay			2.3									
Intersection Capacity Utilization			56.2%		ICU Level of Service				B			
Analysis Period (min)			15									

10: Dover Road & Site Driveway

01/07/2025



Movement	SEL	SER	NEL	NET	SWT	SWR
Lane Configurations						
Traffic Volume (veh/h)	0	0	0	850	824	0
Future Volume (Veh/h)	0	0	0	850	824	0
Sign Control	Stop			Free	Free	
Grade	0%			-3%	3%	
Peak Hour Factor	0.90	0.90	0.90	0.90	0.90	0.90
Hourly flow rate (vph)	0	0	0	944	916	0
Pedestrians	7			7	7	
Lane Width (ft)	12.0			11.0	12.0	
Walking Speed (ft/s)	3.5			3.5	3.5	
Percent Blockage	1			1	1	
Right turn flare (veh)						
Median type				None	None	
Median storage (veh)						
Upstream signal (ft)	313					
pX, platoon unblocked	0.80					
vC, conflicting volume	1874	930	923			
vC1, stage 1 conf vol						
vC2, stage 2 conf vol						
vCu, unblocked vol	1965	930	923			
tC, single (s)	6.4	6.2	4.1			
tC, 2 stage (s)						
tF (s)	3.5	3.3	2.2			
p0 queue free %	100	100	100			
cM capacity (veh/h)	56	323	739			
Direction, Lane #	SE 1	NE 1	SW 1			
Volume Total	0	944	916			
Volume Left	0	0	0			
Volume Right	0	0	0			
cSH	1700	739	1700			
Volume to Capacity	0.00	0.00	0.54			
Queue Length 95th (ft)	0	0	0			
Control Delay (s/veh)	0.0	0.0	0.0			
Lane LOS	A					
Approach Delay (s/veh)	0.0	0.0	0.0			
Approach LOS	A					
Intersection Summary						
Average Delay	0.0					
Intersection Capacity Utilization	56.8%			ICU Level of Service	B	
Analysis Period (min)	15					

2035 Design Year No-Build Saturday Midday Peak Hour



3: Main Street /Dover Road & Newmarket Road/Holiday Inn Express Driveway

01/07/2025



Lane Group	SEL	SET	NWL	NWT	NWR	NEL	NET	NER	SWL	SWT	Ø9
Lane Configurations		↔		↕	↗	↘	↖	↗	↘	↖	↗
Traffic Volume (vph)	4	2	173	0	416	7	446	269	519	344	
Future Volume (vph)	4	2	173	0	416	7	446	269	519	344	
Turn Type	Perm	NA	Perm	NA	Perm	Prot	NA	Perm	Prot	NA	
Protected Phases		4		8		5	2		1	6	9
Permitted Phases	4		8		8			2			
Detector Phase	4	4	8	8	8	5	2	2	1	6	
Switch Phase											
Minimum Initial (s)	5.0	5.0	5.0	5.0	5.0	5.0	5.0	5.0	5.0	5.0	5.0
Minimum Split (s)	11.0	11.0	11.0	11.0	11.0	16.0	16.0	16.0	16.0	16.0	19.0
Total Split (s)	36.0	36.0	36.0	36.0	36.0	19.0	36.0	36.0	36.0	53.0	19.0
Total Split (%)	28.3%	28.3%	28.3%	28.3%	28.3%	15.0%	28.3%	28.3%	28.3%	41.7%	15%
Yellow Time (s)	4.0	4.0	4.0	4.0	4.0	4.0	4.0	4.0	4.0	4.0	2.0
All-Red Time (s)	2.0	2.0	2.0	2.0	2.0	2.0	2.0	2.0	2.0	2.0	0.0
Lost Time Adjust (s)		-2.0		-2.0	-2.0	-2.0	-2.0	-2.0	-2.0	-2.0	
Total Lost Time (s)		4.0		4.0	4.0	4.0	4.0	4.0	4.0	4.0	
Lead/Lag						Lead	Lag	Lag	Lead	Lag	
Lead-Lag Optimize?						Yes	Yes	Yes	Yes	Yes	
Recall Mode	Min	Min	Min	Min	Min	None	Min	Min	Max	Min	None

Intersection Summary

Cycle Length: 127
 Actuated Cycle Length: 108.7
 Natural Cycle: 100
 Control Type: Semi Act-Uncoord

Splits and Phases: 3: Main Street /Dover Road & Newmarket Road/Holiday Inn Express Driveway

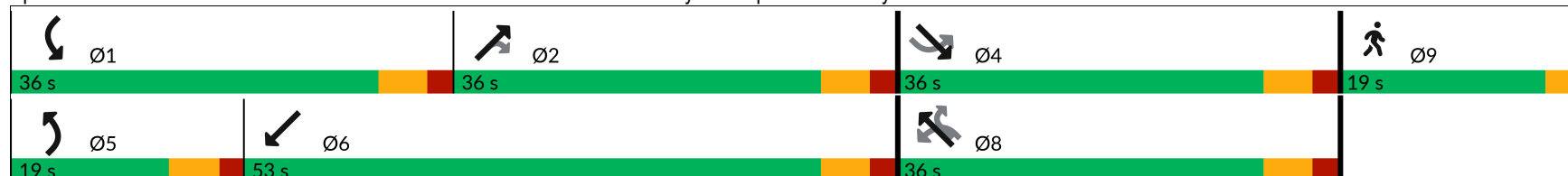

Timings

S:\Jobs\10078 - Durham, NH\Synchro\2035 Design Year No-Build SAT.syn

3: Main Street /Dover Road & Newmarket Road/Holiday Inn Express Driveway

01/07/2025



Lane Group	SET	NWT	NWR	NEL	NET	NER	SWL	SWT
Lane Group Flow (vph)	17	192	462	8	496	299	577	383
v/c Ratio	0.05	0.63	0.65	0.05	0.82	0.44	1.08	0.35
Control Delay (s/veh)	21.9	48.5	8.1	52.3	50.3	6.5	99.2	16.2
Queue Delay	0.0	0.0	0.0	0.0	0.0	0.0	0.0	0.0
Total Delay (s/veh)	21.9	48.5	8.1	52.3	50.3	6.5	99.2	16.2
Queue Length 50th (ft)	3	109	0	5	287	1	~399	92
Queue Length 95th (ft)	23	222	91	23	#618	73	#825	326
Internal Link Dist (ft)	1	409			368			56
Turn Bay Length (ft)			155	35		300		
Base Capacity (vph)	480	395	789	250	620	691	536	1104
Starvation Cap Reductn	0	0	0	0	0	0	0	0
Spillback Cap Reductn	0	0	0	0	0	0	0	0
Storage Cap Reductn	0	0	0	0	0	0	0	0
Reduced v/c Ratio	0.04	0.49	0.59	0.03	0.80	0.43	1.08	0.35

Intersection Summary

~ Volume exceeds capacity, queue is theoretically infinite.





















Queue shown is maximum after two cycles.

95th percentile volume exceeds capacity, queue may be longer.

Queue shown is maximum after two cycles.

3: Main Street /Dover Road & Newmarket Road/Holiday Inn Express Driveway

01/07/2025

												
Movement	SEL	SET	SER	NWL	NWT	NWR	NEL	NET	NER	SWL	SWT	SWR
Lane Configurations												
Traffic Volume (vph)	4	2	10	173	0	416	7	446	269	519	344	1
Future Volume (vph)	4	2	10	173	0	416	7	446	269	519	344	1
Ideal Flow (vphpl)	1900	1900	1900	1900	1900	1900	1900	1900	1900	1900	1900	1900
Lane Width	12	11	12	12	11	12	11	14	12	12	11	12
Grade (%)		0%			4%			-6%			0%	
Total Lost time (s)		4.0			4.0	4.0	4.0	4.0	4.0	4.0	4.0	
Lane Util. Factor		1.00			1.00	1.00	1.00	1.00	1.00	1.00	1.00	
Frbp, ped/bikes		1.00			1.00	1.00	1.00	1.00	0.98	1.00	1.00	
Flpb, ped/bikes		1.00			1.00	1.00	1.00	1.00	1.00	1.00	1.00	
Frt		0.91			1.00	0.85	1.00	1.00	0.85	1.00	1.00	
Flt Protected		0.99			0.95	1.00	0.95	1.00	1.00	0.95	1.00	
Satd. Flow (prot)		1657			1676	1552	1779	2067	1612	1787	1818	
Flt Permitted		0.94			0.75	1.00	0.95	1.00	1.00	0.95	1.00	
Satd. Flow (perm)		1576			1317	1552	1779	2067	1612	1787	1818	
Peak-hour factor, PHF	0.90	0.90	0.90	0.90	0.90	0.90	0.90	0.90	0.90	0.90	0.90	0.90
Adj. Flow (vph)	4	2	11	192	0	462	8	496	299	577	382	1
RTOR Reduction (vph)	0	9	0	0	0	360	0	0	201	0	0	0
Lane Group Flow (vph)	0	8	0	0	192	102	8	496	98	577	383	0
Confl. Bikes (#/hr)									1			2
Heavy Vehicles (%)	0%	0%	0%	2%	2%	2%	1%	1%	1%	1%	1%	1%
Turn Type	Perm	NA		Perm	NA	Perm	Prot	NA	Perm	Prot	NA	
Protected Phases		4			8		5	2		1	6	
Permitted Phases	4			8		8			2			
Actuated Green, G (s)		23.3			23.3	23.3	1.6	35.0	35.0	30.6	64.0	
Effective Green, g (s)		25.3			25.3	25.3	3.6	37.0	37.0	32.6	66.0	
Actuated g/C Ratio		0.22			0.22	0.22	0.03	0.32	0.32	0.28	0.58	
Clearance Time (s)		6.0			6.0	6.0	6.0	6.0	6.0	6.0	6.0	
Vehicle Extension (s)		5.0			5.0	5.0	5.0	5.0	5.0	5.0	5.0	
Lane Grp Cap (vph)		347			290	342	55	666	520	507	1046	
v/s Ratio Prot							0.00	c0.24		c0.32	0.21	
v/s Ratio Perm		0.01			c0.15	0.07			0.06			
v/c Ratio		0.02			0.66	0.30	0.15	0.74	0.19	1.14	0.37	

3: Main Street /Dover Road & Newmarket Road/Holiday Inn Express Driveway

01/07/2025



Movement	SEL	SET	SER	NWL	NWT	NWR	NEL	NET	NER	SWL	SWT	SWR
Uniform Delay, d1		35.0			40.8	37.3	54.1	34.6	28.0	41.1	13.1	
Progression Factor		1.00			1.00	1.00	1.00	1.00	1.00	1.00	1.00	
Incremental Delay, d2		0.1			7.3	1.0	2.5	5.4	0.4	83.8	0.5	
Delay (s)		35.1			48.1	38.3	56.6	40.1	28.4	124.9	13.6	
Level of Service		D			D	D	E	D	C	F	B	
Approach Delay (s/veh)		35.1			41.2			35.9			80.5	
Approach LOS		D			D			D			F	

Intersection Summary		
HCM 2000 Control Delay (s/veh)	54.9	HCM 2000 Level of Service D
HCM 2000 Volume to Capacity ratio	0.81	
Actuated Cycle Length (s)	114.7	Sum of lost time (s) 14.0
Intersection Capacity Utilization	78.5%	ICU Level of Service D
Analysis Period (min)	15	

c Critical Lane Group



Movement	NWL	NWR	NET	NER	SWL	SWT
Lane Configurations			↔			↕↕
Traffic Volume (veh/h)	0	0	781	85	3	864
Future Volume (Veh/h)	0	0	781	85	3	864
Sign Control	Stop		Free		Free	
Grade	0%		-3%		3%	
Peak Hour Factor	0.90	0.90	0.90	0.90	0.90	0.90
Hourly flow rate (vph)	0	0	868	94	3	960
Pedestrians	2					
Lane Width (ft)	0.0					
Walking Speed (ft/s)	3.5					
Percent Blockage	0					
Right turn flare (veh)						
Median type	None			None		
Median storage veh						
Upstream signal (ft)	136					
pX, platoon unblocked	0.78	0.78			0.78	
vC, conflicting volume	1403	917			964	
vC1, stage 1 conf vol						
vC2, stage 2 conf vol						
vCu, unblocked vol	1376	754			814	
tC, single (s)	6.8	6.9			4.1	
tC, 2 stage (s)						
tF (s)	3.5	3.3			2.2	
p0 queue free %	100	100			100	
cM capacity (veh/h)	108	278			637	
Direction, Lane #	NE 1	SW 1	SW 2			
Volume Total	962	323	640			
Volume Left	0	3	0			
Volume Right	94	0	0			
cSH	1700	637	1700			
Volume to Capacity	0.57	0.00	0.38			
Queue Length 95th (ft)	0	0	0			
Control Delay (s/veh)	0.0	0.2	0.0			
Lane LOS	A					
Approach Delay (s/veh)	0.0	0.1				
Approach LOS						
Intersection Summary						
Average Delay			0.0			
Intersection Capacity Utilization			49.6%	ICU Level of Service		A
Analysis Period (min)			15			



Movement	SEL	SET	SER	NWL	NWT	NWR	NEL	NET	NER	SWL	SWT	SWR
Lane Configurations		↔			↔	↔		↔			↔↔	
Traffic Volume (veh/h)	1	0	2	48	0	73	0	777	4	25	817	2
Future Volume (Veh/h)	1	0	2	48	0	73	0	777	4	25	817	2
Sign Control		Stop			Stop			Free			Free	
Grade		0%			0%			-3%			3%	
Peak Hour Factor	0.90	0.90	0.90	0.90	0.90	0.90	0.90	0.90	0.90	0.90	0.90	0.90
Hourly flow rate (vph)	1	0	2	53	0	81	0	863	4	28	908	2
Pedestrians		5			2			7			5	
Lane Width (ft)		11.0			10.0			12.0			12.0	
Walking Speed (ft/s)		3.5			3.5			3.5			3.5	
Percent Blockage		0			0			1			0	
Right turn flare (veh)												
Median type								None			None	
Median storage veh												
Upstream signal (ft)								223				
pX, platoon unblocked	0.78	0.78		0.78	0.78	0.78				0.78		
vC, conflicting volume	1921	1839	467	1386	1838	872	915			869		
vC1, stage 1 conf vol												
vC2, stage 2 conf vol												
vCu, unblocked vol	2037	1933	467	1355	1931	699	915			695		
tC, single (s)	7.5	6.5	6.9	7.5	6.5	6.9	4.1			4.1		
tC, 2 stage (s)												
tF (s)	3.5	4.0	3.3	3.5	4.0	3.3	2.2			2.2		
p0 queue free %	95	100	100	36	100	73	100			96		
cM capacity (veh/h)	19	50	542	82	50	301	744			707		
Direction, Lane #	SE 1	NW 1	NW 2	NE 1	SW 1	SW 2						
Volume Total	3	53	81	867	482	456						
Volume Left	1	53	0	0	28	0						
Volume Right	2	0	81	4	0	2						
cSH	52	82	301	744	707	1700						
Volume to Capacity	0.06	0.64	0.27	0.00	0.04	0.27						
Queue Length 95th (ft)	4	75	27	0	3	0						
Control Delay (s/veh)	78.1	106.8	21.3	0.0	1.1	0.0						
Lane LOS	F	F	C		A							
Approach Delay (s/veh)	78.1	55.1		0.0	0.6							
Approach LOS	F	F										
Intersection Summary												
Average Delay			4.2									
Intersection Capacity Utilization			61.8%		ICU Level of Service				B			
Analysis Period (min)			15									

10: Dover Road & Site Driveway

01/07/2025



Movement	SEL	SER	NEL	NET	SWT	SWR
Lane Configurations						
Traffic Volume (veh/h)	0	0	0	851	844	0
Future Volume (Veh/h)	0	0	0	851	844	0
Sign Control	Stop			Free	Free	
Grade	0%			-3%	3%	
Peak Hour Factor	0.90	0.90	0.90	0.90	0.90	0.90
Hourly flow rate (vph)	0	0	0	946	938	0
Pedestrians						
Lane Width (ft)						
Walking Speed (ft/s)						
Percent Blockage						
Right turn flare (veh)						
Median type				None	None	
Median storage (veh)						
Upstream signal (ft)	313					
pX, platoon unblocked	0.78					
vC, conflicting volume	1884	938	938			
vC1, stage 1 conf vol						
vC2, stage 2 conf vol						
vCu, unblocked vol	1990	938	938			
tC, single (s)	6.4	6.2	4.1			
tC, 2 stage (s)						
tF (s)	3.5	3.3	2.2			
p0 queue free %	100	100	100			
cM capacity (veh/h)	53	323	735			
Direction, Lane #	SE 1	NE 1	SW 1			
Volume Total	0	946	938			
Volume Left	0	0	0			
Volume Right	0	0	0			
cSH	1700	735	1700			
Volume to Capacity	0.00	0.00	0.55			
Queue Length 95th (ft)	0	0	0			
Control Delay (s/veh)	0.0	0.0	0.0			
Lane LOS	A					
Approach Delay (s/veh)	0.0	0.0	0.0			
Approach LOS	A					
Intersection Summary						
Average Delay				0.0		
Intersection Capacity Utilization				48.1%	ICU Level of Service	A
Analysis Period (min)				15		

2035 Design Year Build Weekday Morning Peak Hour



3: Main Street /Dover Road & Newmarket Road/Holiday Inn Express Driveway

01/07/2025



Lane Group	SEL	SET	NWL	NWT	NWR	NEL	NET	NER	SWL	SWT	Ø9
Lane Configurations		↔		↕	↗	↖	↗	↖	↖	↗	↖
Traffic Volume (vph)	3	0	172	0	544	2	196	106	451	290	
Future Volume (vph)	3	0	172	0	544	2	196	106	451	290	
Turn Type	Perm	NA	Perm	NA	Perm	Prot	NA	Perm	Prot	NA	
Protected Phases		4		8		5	2		1	6	9
Permitted Phases	4		8		8			2			
Detector Phase	4	4	8	8	8	5	2	2	1	6	
Switch Phase											
Minimum Initial (s)	5.0	5.0	5.0	5.0	5.0	5.0	5.0	5.0	5.0	5.0	5.0
Minimum Split (s)	11.0	11.0	11.0	11.0	11.0	16.0	16.0	16.0	16.0	16.0	20.0
Total Split (s)	36.0	36.0	36.0	36.0	36.0	19.0	36.0	36.0	36.0	53.0	19.0
Total Split (%)	28.3%	28.3%	28.3%	28.3%	28.3%	15.0%	28.3%	28.3%	28.3%	41.7%	15%
Yellow Time (s)	4.0	4.0	4.0	4.0	4.0	4.0	4.0	4.0	4.0	4.0	2.0
All-Red Time (s)	2.0	2.0	2.0	2.0	2.0	2.0	2.0	2.0	2.0	2.0	0.0
Lost Time Adjust (s)		-2.0		-2.0	-2.0	-2.0	-2.0	-2.0	-2.0	-2.0	
Total Lost Time (s)		4.0		4.0	4.0	4.0	4.0	4.0	4.0	4.0	
Lead/Lag						Lead	Lag	Lag	Lead	Lag	
Lead-Lag Optimize?						Yes	Yes	Yes	Yes	Yes	
Recall Mode	Min	Min	Min	Min	Min	None	Min	Min	Max	Min	None

Intersection Summary

Cycle Length: 127
 Actuated Cycle Length: 92.8
 Natural Cycle: 90
 Control Type: Semi Act-Uncoord

Splits and Phases: 3: Main Street /Dover Road & Newmarket Road/Holiday Inn Express Driveway

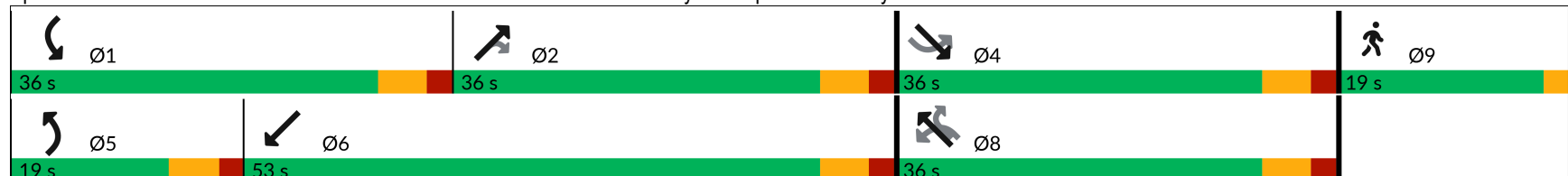

Timings

S:\Jobs\10078 - Durham, NH\Synchro\2035 Design Year Build AM.syn

3: Main Street /Dover Road & Newmarket Road/Holiday Inn Express Driveway

01/07/2025























Lane Group	SET	NWT	NWR	NEL	NET	NER	SWL	SWT
Lane Group Flow (vph)	6	191	604	2	218	118	501	322
v/c Ratio	0.01	0.54	0.70	0.01	0.51	0.26	0.80	0.31
Control Delay (s/veh)	0.0	37.6	7.9	46.5	38.7	4.9	41.7	14.3
Queue Delay	0.0	0.0	0.0	0.0	0.0	0.0	0.0	0.0
Total Delay (s/veh)	0.0	37.6	7.9	46.5	38.7	4.9	41.7	14.3
Queue Length 50th (ft)	0	88	0	1	108	0	245	74
Queue Length 95th (ft)	0	217	107	10	232	30	#685	270
Internal Link Dist (ft)	1	409			368			56
Turn Bay Length (ft)			155	35		300		
Base Capacity (vph)	642	479	947	286	708	658	624	1055
Starvation Cap Reductn	0	0	0	0	0	0	0	0
Spillback Cap Reductn	0	0	0	0	0	0	0	0
Storage Cap Reductn	0	0	0	0	0	0	0	0
Reduced v/c Ratio	0.01	0.40	0.64	0.01	0.31	0.18	0.80	0.31

Intersection Summary

95th percentile volume exceeds capacity, queue may be longer.
 Queue shown is maximum after two cycles.

3: Main Street /Dover Road & Newmarket Road/Holiday Inn Express Driveway

01/07/2025

												
Movement	SEL	SET	SER	NWL	NWT	NWR	NEL	NET	NER	SWL	SWT	SWR
Lane Configurations												
Traffic Volume (vph)	3	0	3	172	0	544	2	196	106	451	290	0
Future Volume (vph)	3	0	3	172	0	544	2	196	106	451	290	0
Ideal Flow (vphpl)	1900	1900	1900	1900	1900	1900	1900	1900	1900	1900	1900	1900
Lane Width	12	11	12	12	11	12	11	14	12	12	11	12
Grade (%)		0%			4%			-6%			0%	
Total Lost time (s)		4.0			4.0	4.0	4.0	4.0	4.0	4.0	4.0	
Lane Util. Factor		1.00			1.00	1.00	1.00	1.00	1.00	1.00	1.00	
Frbp, ped/bikes		1.00			1.00	1.00	1.00	1.00	1.00	1.00	1.00	
Flpb, ped/bikes		1.00			1.00	1.00	1.00	1.00	1.00	1.00	1.00	
Frt		0.93			1.00	0.85	1.00	1.00	0.85	1.00	1.00	
Flt Protected		0.98			0.95	1.00	0.95	1.00	1.00	0.95	1.00	
Satd. Flow (prot)		1671			1693	1567	1712	1988	1584	1752	1783	
Flt Permitted		0.90			0.75	1.00	0.95	1.00	1.00	0.95	1.00	
Satd. Flow (perm)		1540			1343	1567	1712	1988	1584	1752	1783	
Peak-hour factor, PHF	0.90	0.90	0.90	0.90	0.90	0.90	0.90	0.90	0.90	0.90	0.90	0.90
Adj. Flow (vph)	3	0	3	191	0	604	2	218	118	501	322	0
RTOR Reduction (vph)	0	5	0	0	0	455	0	0	88	0	0	0
Lane Group Flow (vph)	0	1	0	0	191	149	2	218	30	501	322	0
Confl. Bikes (#/hr)												2
Heavy Vehicles (%)	0%	0%	0%	1%	1%	1%	5%	5%	5%	3%	3%	3%
Turn Type	Perm	NA		Perm	NA	Perm	Prot	NA	Perm	Prot	NA	
Protected Phases		4			8		5	2		1	6	
Permitted Phases	4			8		8			2			
Actuated Green, G (s)		22.5			22.5	22.5	1.2	23.1	23.1	31.0	52.9	
Effective Green, g (s)		24.5			24.5	24.5	3.2	25.1	25.1	33.0	54.9	
Actuated g/C Ratio		0.25			0.25	0.25	0.03	0.25	0.25	0.33	0.55	
Clearance Time (s)		6.0			6.0	6.0	6.0	6.0	6.0	6.0	6.0	
Vehicle Extension (s)		5.0			5.0	5.0	5.0	5.0	5.0	5.0	5.0	
Lane Grp Cap (vph)		379			331	386	55	502	400	582	985	
v/s Ratio Prot							0.00	c0.11		c0.29	0.18	
v/s Ratio Perm		0.00			c0.14	0.10			0.02			
v/c Ratio		0.00			0.58	0.39	0.04	0.43	0.07	0.86	0.33	

3: Main Street /Dover Road & Newmarket Road/Holiday Inn Express Driveway

01/07/2025



Movement	SEL	SET	SER	NWL	NWT	NWR	NEL	NET	NER	SWL	SWT	SWR	
Uniform Delay, d1		28.2			32.8	31.1	46.6	31.1	28.3	31.0	12.1		
Progression Factor		1.00			1.00	1.00	1.00	1.00	1.00	1.00	1.00		
Incremental Delay, d2		0.0			3.9	1.3	0.6	1.3	0.2	15.4	0.4		
Delay (s)		28.2			36.7	32.5	47.1	32.4	28.4	46.4	12.5		
Level of Service		C			D	C	D	C	C	D	B		
Approach Delay (s/veh)		28.2			33.5			31.1			33.1		
Approach LOS		C			C			C			C		
Intersection Summary													
HCM 2000 Control Delay (s/veh)			32.9		HCM 2000 Level of Service					C			
HCM 2000 Volume to Capacity ratio			0.63										
Actuated Cycle Length (s)			99.3		Sum of lost time (s)					14.0			
Intersection Capacity Utilization			61.5%		ICU Level of Service					B			
Analysis Period (min)			15										

c Critical Lane Group

5: Dover Road & Irving Gas Station Driveway

01/07/2025



Movement	NWL	NWR	NET	NER	SWL	SWT
Lane Configurations			↔			↔↔
Traffic Volume (veh/h)	0	0	712	31	5	741
Future Volume (Veh/h)	0	0	712	31	5	741
Sign Control	Stop		Free			Free
Grade	0%		-3%			3%
Peak Hour Factor	0.90	0.90	0.90	0.90	0.90	0.90
Hourly flow rate (vph)	0	0	791	34	6	823
Pedestrians						
Lane Width (ft)						
Walking Speed (ft/s)						
Percent Blockage						
Right turn flare (veh)						
Median type			None			None
Median storage (veh)						
Upstream signal (ft)	136					
pX, platoon unblocked	0.91	0.91			0.91	
vC, conflicting volume	1232	808			825	
vC1, stage 1 conf vol						
vC2, stage 2 conf vol						
vCu, unblocked vol	1204	737			755	
tC, single (s)	6.8	6.9			4.2	
tC, 2 stage (s)						
tF (s)	3.5	3.3			2.2	
p0 queue free %	100	100			99	
cM capacity (veh/h)	162	331			766	
Direction, Lane #	NE 1	SW 1	SW 2			
Volume Total	825	280	549			
Volume Left	0	6	0			
Volume Right	34	0	0			
cSH	1700	766	1700			
Volume to Capacity	0.49	0.01	0.32			
Queue Length 95th (ft)	0	1	0			
Control Delay (s/veh)	0.0	0.3	0.0			
Lane LOS		A				
Approach Delay (s/veh)	0.0	0.1				
Approach LOS						
Intersection Summary						
Average Delay			0.1			
Intersection Capacity Utilization			42.7%	ICU Level of Service	A	
Analysis Period (min)			15			



Movement	SEL	SET	SER	NWL	NWT	NWR	NEL	NET	NER	SWL	SWT	SWR
Lane Configurations		↔			↔	↔		↔			↔↔	
Traffic Volume (veh/h)	0	0	0	6	0	51	0	709	3	5	740	1
Future Volume (Veh/h)	0	0	0	6	0	51	0	709	3	5	740	1
Sign Control		Stop			Stop			Free			Free	
Grade		0%			0%			-3%			3%	
Peak Hour Factor	0.90	0.90	0.90	0.90	0.90	0.90	0.90	0.90	0.90	0.90	0.90	0.90
Hourly flow rate (vph)	0	0	0	7	0	57	0	788	3	6	822	1
Pedestrians												
Lane Width (ft)												
Walking Speed (ft/s)												
Percent Blockage												
Right turn flare (veh)												
Median type												
								None			None	
Median storage veh												
Upstream signal (ft)												
								223				
pX, platoon unblocked	0.91	0.91		0.91	0.91	0.91					0.91	
vC, conflicting volume	1681	1626	412	1213	1625	790	823				791	
vC1, stage 1 conf vol												
vC2, stage 2 conf vol												
vCu, unblocked vol	1699	1638	412	1183	1637	717	823				719	
tC, single (s)	7.5	6.5	6.9	7.5	6.5	6.9	4.1				4.1	
tC, 2 stage (s)												
tF (s)	3.5	4.0	3.3	3.5	4.0	3.3	2.2				2.2	
p0 queue free %	100	100	100	95	100	83	100				99	
cM capacity (veh/h)	46	91	595	133	92	342	803				797	
Direction, Lane #												
	SE 1	NW 1	NW 2	NE 1	SW 1	SW 2						
Volume Total	0	7	57	791	417	412						
Volume Left	0	7	0	0	6	0						
Volume Right	0	0	57	3	0	1						
cSH	1700	133	342	803	797	1700						
Volume to Capacity	0.00	0.05	0.17	0.00	0.01	0.24						
Queue Length 95th (ft)	0	4	15	0	1	0						
Control Delay (s/veh)	0.0	33.6	17.6	0.0	0.2	0.0						
Lane LOS	A	D	C		A							
Approach Delay (s/veh)	0.0	19.4		0.0	0.1							
Approach LOS	A	C										
Intersection Summary												
Average Delay			0.8									
Intersection Capacity Utilization			47.5%		ICU Level of Service				A			
Analysis Period (min)			15									

10: Dover Road & Site Driveway

01/07/2025



Movement	SEL	SER	NEL	NET	SWT	SWR
Lane Configurations						
Traffic Volume (veh/h)	53	47	49	711	699	34
Future Volume (Veh/h)	53	47	49	711	699	34
Sign Control	Stop			Free	Free	
Grade	0%			-3%	3%	
Peak Hour Factor	0.90	0.90	0.90	0.90	0.90	0.90
Hourly flow rate (vph)	59	52	54	790	777	38
Pedestrians						
Lane Width (ft)						
Walking Speed (ft/s)						
Percent Blockage						
Right turn flare (veh)						
Median type				None	None	
Median storage veh						
Upstream signal (ft)	313					
pX, platoon unblocked	0.91					
vC, conflicting volume	1694	796	815			
vC1, stage 1 conf vol						
vC2, stage 2 conf vol						
vCu, unblocked vol	1714	796	815			
tC, single (s)	6.4	6.2	4.1			
tC, 2 stage (s)						
tF (s)	3.5	3.3	2.2			
p0 queue free %	31	87	93			
cM capacity (veh/h)	85	390	812			
Direction, Lane #	SE 1	NE 1	SW 1			
Volume Total	111	844	815			
Volume Left	59	54	0			
Volume Right	52	0	38			
cSH	134	812	1700			
Volume to Capacity	0.83	0.07	0.48			
Queue Length 95th (ft)	129	5	0			
Control Delay (s/veh)	99.9	1.8	0.0			
Lane LOS	F	A				
Approach Delay (s/veh)	99.9	1.8	0.0			
Approach LOS	F					
Intersection Summary						
Average Delay			7.1			
Intersection Capacity Utilization			90.2%	ICU Level of Service	E	
Analysis Period (min)			15			

2035 Design Year Build Weekday Evening Peak Hour



3: Main Street /Dover Road & Newmarket Road/Holiday Inn Express Driveway

01/07/2025



Lane Group	SEL	SET	NWL	NWT	NWR	NEL	NET	NER	SWL	SWT	Ø9
Lane Configurations		↔		↔	↔	↔	↔	↔	↔	↔	
Traffic Volume (vph)	1	2	155	2	447	12	415	205	521	309	
Future Volume (vph)	1	2	155	2	447	12	415	205	521	309	
Turn Type	Perm	NA	Perm	NA	Perm	Prot	NA	Perm	Prot	NA	
Protected Phases		4		8		5	2		1	6	9
Permitted Phases	4		8		8			2			
Detector Phase	4	4	8	8	8	5	2	2	1	6	
Switch Phase											
Minimum Initial (s)	5.0	5.0	5.0	5.0	5.0	5.0	5.0	5.0	5.0	5.0	5.0
Minimum Split (s)	11.0	11.0	11.0	11.0	11.0	16.0	16.0	16.0	16.0	16.0	19.0
Total Split (s)	36.0	36.0	36.0	36.0	36.0	19.0	36.0	36.0	36.0	53.0	19.0
Total Split (%)	28.3%	28.3%	28.3%	28.3%	28.3%	15.0%	28.3%	28.3%	28.3%	41.7%	15%
Yellow Time (s)	4.0	4.0	4.0	4.0	4.0	4.0	4.0	4.0	4.0	4.0	2.0
All-Red Time (s)	2.0	2.0	2.0	2.0	2.0	2.0	2.0	2.0	2.0	2.0	0.0
Lost Time Adjust (s)		-2.0		-2.0	-2.0	-2.0	-2.0	-2.0	-2.0	-2.0	
Total Lost Time (s)		4.0		4.0	4.0	4.0	4.0	4.0	4.0	4.0	
Lead/Lag						Lead	Lag	Lag	Lead	Lag	
Lead-Lag Optimize?						Yes	Yes	Yes	Yes	Yes	
Recall Mode	Min	Min	Min	Min	Min	None	Min	Min	Max	Min	None

Intersection Summary

Cycle Length: 127
 Actuated Cycle Length: 102.7
 Natural Cycle: 90
 Control Type: Semi Act-Uncoord

Splits and Phases: 3: Main Street /Dover Road & Newmarket Road/Holiday Inn Express Driveway

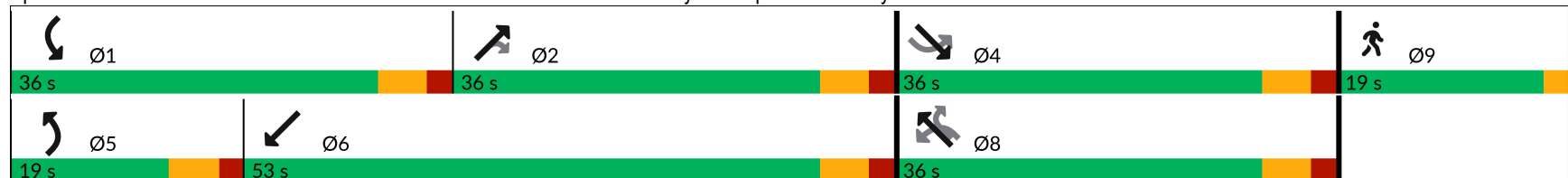

Timings

S:\Jobs\10078 - Durham, NH\Synchro\2035 Design Year Build PM.syn

3: Main Street /Dover Road & Newmarket Road/Holiday Inn Express Driveway

01/07/2025



Lane Group	SET	NWT	NWR	NEL	NET	NER	SWL	SWT
Lane Group Flow (vph)	11	174	497	13	461	228	579	347
v/c Ratio	0.03	0.57	0.66	0.07	0.75	0.35	1.02	0.30
Control Delay (s/veh)	21.1	43.7	7.9	48.4	43.2	6.1	80.5	13.7
Queue Delay	0.0	0.0	0.0	0.0	0.0	0.0	0.0	0.0
Total Delay (s/veh)	21.1	43.7	7.9	48.4	43.2	6.1	80.5	13.7
Queue Length 50th (ft)	2	98	0	8	260	0	~400	81
Queue Length 95th (ft)	18	203	95	32	#549	63	#830	294
Internal Link Dist (ft)	1	409			368			56
Turn Bay Length (ft)			155	35		300		
Base Capacity (vph)	521	407	836	267	662	683	567	1138
Starvation Cap Reductn	0	0	0	0	0	0	0	0
Spillback Cap Reductn	0	0	0	0	0	0	0	0
Storage Cap Reductn	0	0	0	0	0	0	0	0
Reduced v/c Ratio	0.02	0.43	0.59	0.05	0.70	0.33	1.02	0.30

Intersection Summary

~ Volume exceeds capacity, queue is theoretically infinite.

Queue shown is maximum after two cycles.

95th percentile volume exceeds capacity, queue may be longer.

Queue shown is maximum after two cycles.

3: Main Street /Dover Road & Newmarket Road/Holiday Inn Express Driveway

01/07/2025



Movement	SEL	SET	SER	NWL	NWT	NWR	NEL	NET	NER	SWL	SWT	SWR
Lane Configurations		↔			↕	↗	↖	↘	↙	↖	↗	↘
Traffic Volume (vph)	1	2	7	155	2	447	12	415	205	521	309	4
Future Volume (vph)	1	2	7	155	2	447	12	415	205	521	309	4
Ideal Flow (vphpl)	1900	1900	1900	1900	1900	1900	1900	1900	1900	1900	1900	1900
Lane Width	12	11	12	12	11	12	11	14	12	12	11	12
Grade (%)		0%			4%			-6%			0%	
Total Lost time (s)		4.0			4.0	4.0	4.0	4.0	4.0	4.0	4.0	
Lane Util. Factor		1.00			1.00	1.00	1.00	1.00	1.00	1.00	1.00	
Frbp, ped/bikes		1.00			1.00	1.00	1.00	1.00	1.00	1.00	1.00	
Flpb, ped/bikes		1.00			1.00	1.00	1.00	1.00	1.00	1.00	1.00	
Frt		0.90			1.00	0.85	1.00	1.00	0.85	1.00	1.00	
Flt Protected		1.00			0.95	1.00	0.95	1.00	1.00	0.95	1.00	
Satd. Flow (prot)		1649			1698	1567	1797	2087	1663	1787	1815	
Flt Permitted		0.98			0.72	1.00	0.95	1.00	1.00	0.95	1.00	
Satd. Flow (perm)		1626			1285	1567	1797	2087	1663	1787	1815	
Peak-hour factor, PHF	0.90	0.90	0.90	0.90	0.90	0.90	0.90	0.90	0.90	0.90	0.90	0.90
Adj. Flow (vph)	1	2	8	172	2	497	13	461	228	579	343	4
RTOR Reduction (vph)	0	6	0	0	0	386	0	0	154	0	0	0
Lane Group Flow (vph)	0	5	0	0	174	111	13	461	74	579	347	0
Confl. Bikes (#/hr)												2
Heavy Vehicles (%)	0%	0%	0%	1%	1%	1%	0%	0%	0%	1%	1%	1%
Turn Type	Perm	NA		Perm	NA	Perm	Prot	NA	Perm	Prot	NA	
Protected Phases		4			8		5	2		1	6	
Permitted Phases	4			8		8			2			
Actuated Green, G (s)		22.4			22.4	22.4	1.6	33.4	33.4	30.5	62.3	
Effective Green, g (s)		24.4			24.4	24.4	3.6	35.4	35.4	32.5	64.3	
Actuated g/C Ratio		0.22			0.22	0.22	0.03	0.32	0.32	0.30	0.59	
Clearance Time (s)		6.0			6.0	6.0	6.0	6.0	6.0	6.0	6.0	
Vehicle Extension (s)		5.0			5.0	5.0	5.0	5.0	5.0	5.0	5.0	
Lane Grp Cap (vph)		363			287	350	59	677	540	532	1070	
v/s Ratio Prot							0.01	c0.22		c0.32	0.19	
v/s Ratio Perm		0.00			c0.14	0.07			0.04			
v/c Ratio		0.01			0.61	0.32	0.22	0.68	0.14	1.09	0.32	

3: Main Street /Dover Road & Newmarket Road/Holiday Inn Express Driveway

01/07/2025



Movement	SEL	SET	SER	NWL	NWT	NWR	NEL	NET	NER	SWL	SWT	SWR	
Uniform Delay, d1		32.9			38.0	35.3	51.3	31.9	26.0	38.3	11.3		
Progression Factor		1.00			1.00	1.00	1.00	1.00	1.00	1.00	1.00		
Incremental Delay, d2		0.0			5.3	1.1	3.9	3.6	0.2	65.2	0.4		
Delay (s)		33.0			43.2	36.4	55.3	35.5	26.3	103.4	11.7		
Level of Service		C			D	D	E	D	C	F	B		
Approach Delay (s/veh)		33.0			38.2			32.9			69.1		
Approach LOS		C			D			C			E		
Intersection Summary													
HCM 2000 Control Delay (s/veh)			48.9		HCM 2000 Level of Service					D			
HCM 2000 Volume to Capacity ratio			0.78										
Actuated Cycle Length (s)			109.0		Sum of lost time (s)					14.0			
Intersection Capacity Utilization			76.1%		ICU Level of Service					D			
Analysis Period (min)			15										

c Critical Lane Group

5: Dover Road & Irving Gas Station Driveway

01/07/2025



Movement	NWL	NWR	NET	NER	SWL	SWT
Lane Configurations			↔			↔↔
Traffic Volume (veh/h)	0	0	804	59	3	834
Future Volume (Veh/h)	0	0	804	59	3	834
Sign Control	Stop		Free		Free	
Grade	0%		-3%		3%	
Peak Hour Factor	0.90	0.90	0.90	0.90	0.90	0.90
Hourly flow rate (vph)	0	0	893	66	3	927
Pedestrians	5					
Lane Width (ft)	0.0					
Walking Speed (ft/s)	3.5					
Percent Blockage	0					
Right turn flare (veh)						
Median type	None			None		
Median storage veh						
Upstream signal (ft)	136					
pX, platoon unblocked	0.80	0.80			0.80	
vC, conflicting volume	1401	931			964	
vC1, stage 1 conf vol						
vC2, stage 2 conf vol						
vCu, unblocked vol	1376	792			833	
tC, single (s)	6.8	6.9			4.1	
tC, 2 stage (s)						
tF (s)	3.5	3.3			2.2	
p0 queue free %	100	100			100	
cM capacity (veh/h)	111	270			645	
Direction, Lane #	NE 1	SW 1	SW 2			
Volume Total	959	312	618			
Volume Left	0	3	0			
Volume Right	66	0	0			
cSH	1700	645	1700			
Volume to Capacity	0.56	0.00	0.36			
Queue Length 95th (ft)	0	0	0			
Control Delay (s/veh)	0.0	0.2	0.0			
Lane LOS	A					
Approach Delay (s/veh)	0.0	0.1				
Approach LOS						
Intersection Summary						
Average Delay	0.0					
Intersection Capacity Utilization	49.3%		ICU Level of Service		A	
Analysis Period (min)	15					



Movement	SEL	SET	SER	NWL	NWT	NWR	NEL	NET	NER	SWL	SWT	SWR
Lane Configurations		↔			↔	↔		↔			↔↔	
Traffic Volume (veh/h)	0	0	0	20	0	49	0	800	4	9	817	2
Future Volume (Veh/h)	0	0	0	20	0	49	0	800	4	9	817	2
Sign Control		Stop			Stop			Free			Free	
Grade		0%			0%			-3%			3%	
Peak Hour Factor	0.90	0.90	0.90	0.90	0.90	0.90	0.90	0.90	0.90	0.90	0.90	0.90
Hourly flow rate (vph)	0	0	0	22	0	54	0	889	4	10	908	2
Pedestrians		5			12			12			12	
Lane Width (ft)		11.0			10.0			12.0			12.0	
Walking Speed (ft/s)		3.5			3.5			3.5			3.5	
Percent Blockage		0			1			1			1	
Right turn flare (veh)												
Median type								None			None	
Median storage (veh)												
Upstream signal (ft)								223				
pX, platoon unblocked	0.80	0.80		0.80	0.80	0.80				0.80		
vC, conflicting volume	1891	1839	472	1389	1838	915	915			905		
vC1, stage 1 conf vol												
vC2, stage 2 conf vol												
vCu, unblocked vol	1986	1921	472	1362	1920	773	915			761		
tC, single (s)	7.5	6.5	6.9	7.5	6.5	6.9	4.1			4.1		
tC, 2 stage (s)												
tF (s)	3.5	4.0	3.3	3.5	4.0	3.3	2.2			2.2		
p0 queue free %	100	100	100	74	100	80	100			99		
cM capacity (veh/h)	23	53	535	84	53	273	744			680		
Direction, Lane #	SE 1	NW 1	NW 2	NE 1	SW 1	SW 2						
Volume Total	0	22	54	893	464	456						
Volume Left	0	22	0	0	10	0						
Volume Right	0	0	54	4	0	2						
cSH	1700	84	273	744	680	1700						
Volume to Capacity	0.00	0.26	0.20	0.00	0.01	0.27						
Queue Length 95th (ft)	0	24	18	0	1	0						
Control Delay (s/veh)	0.0	62.6	21.4	0.0	0.4	0.0						
Lane LOS	A	F	C		A							
Approach Delay (s/veh)	0.0	33.4		0.0	0.2							
Approach LOS	A	D										
Intersection Summary												
Average Delay			1.4									
Intersection Capacity Utilization			56.3%		ICU Level of Service				B			
Analysis Period (min)			15									

10: Dover Road & Site Driveway

01/07/2025



Movement	SEL	SER	NEL	NET	SWT	SWR
Lane Configurations						
Traffic Volume (veh/h)	22	18	20	829	810	15
Future Volume (Veh/h)	22	18	20	829	810	15
Sign Control	Stop			Free	Free	
Grade	0%			-3%	3%	
Peak Hour Factor	0.90	0.90	0.90	0.90	0.90	0.90
Hourly flow rate (vph)	24	20	22	921	900	17
Pedestrians	7			7	7	
Lane Width (ft)	12.0			11.0	12.0	
Walking Speed (ft/s)	3.5			3.5	3.5	
Percent Blockage	1			1	1	
Right turn flare (veh)						
Median type				None	None	
Median storage (veh)						
Upstream signal (ft)				313		
pX, platoon unblocked	0.80					
vC, conflicting volume	1888	923	924			
vC1, stage 1 conf vol						
vC2, stage 2 conf vol						
vCu, unblocked vol	1982	923	924			
tC, single (s)	6.4	6.2	4.1			
tC, 2 stage (s)						
tF (s)	3.5	3.3	2.2			
p0 queue free %	54	94	97			
cM capacity (veh/h)	53	326	739			
Direction, Lane #	SE 1	NE 1	SW 1			
Volume Total	44	943	917			
Volume Left	24	22	0			
Volume Right	20	0	17			
cSH	85	739	1700			
Volume to Capacity	0.52	0.03	0.54			
Queue Length 95th (ft)	56	2	0			
Control Delay (s/veh)	85.9	0.9	0.0			
Lane LOS	F	A				
Approach Delay (s/veh)	85.9	0.9	0.0			
Approach LOS	F					
Intersection Summary						
Average Delay			2.4			
Intersection Capacity Utilization			71.8%	ICU Level of Service	C	
Analysis Period (min)			15			

2035 Design Year Build Saturday Midday Peak Hour



3: Main Street /Dover Road & Newmarket Road/Holiday Inn Express Driveway

01/07/2025



Lane Group	SEL	SET	NWL	NWT	NWR	NEL	NET	NER	SWL	SWT	Ø9
Lane Configurations		↔		↕	↗	↘	↕	↗	↘	↕	
Traffic Volume (vph)	3	0	172	0	541	2	195	106	441	288	
Future Volume (vph)	3	0	172	0	541	2	195	106	441	288	
Turn Type	Perm	NA	Perm	NA	Perm	Prot	NA	Perm	Prot	NA	
Protected Phases		4		8		5	2		1	6	9
Permitted Phases	4		8		8			2			
Detector Phase	4	4	8	8	8	5	2	2	1	6	
Switch Phase											
Minimum Initial (s)	5.0	5.0	5.0	5.0	5.0	5.0	5.0	5.0	5.0	5.0	5.0
Minimum Split (s)	11.0	11.0	11.0	11.0	11.0	16.0	16.0	16.0	16.0	16.0	20.0
Total Split (s)	36.0	36.0	36.0	36.0	36.0	19.0	36.0	36.0	36.0	53.0	19.0
Total Split (%)	28.3%	28.3%	28.3%	28.3%	28.3%	15.0%	28.3%	28.3%	28.3%	41.7%	15%
Yellow Time (s)	4.0	4.0	4.0	4.0	4.0	4.0	4.0	4.0	4.0	4.0	2.0
All-Red Time (s)	2.0	2.0	2.0	2.0	2.0	2.0	2.0	2.0	2.0	2.0	0.0
Lost Time Adjust (s)		-2.0		-2.0	-2.0	-2.0	-2.0	-2.0	-2.0	-2.0	
Total Lost Time (s)		4.0		4.0	4.0	4.0	4.0	4.0	4.0	4.0	
Lead/Lag						Lead	Lag	Lag	Lead	Lag	
Lead-Lag Optimize?						Yes	Yes	Yes	Yes	Yes	
Recall Mode	Min	Min	Min	Min	Min	None	Min	Min	Max	Min	None

Intersection Summary

Cycle Length: 127
 Actuated Cycle Length: 92.8
 Natural Cycle: 80
 Control Type: Semi Act-Uncoord

Splits and Phases: 3: Main Street /Dover Road & Newmarket Road/Holiday Inn Express Driveway

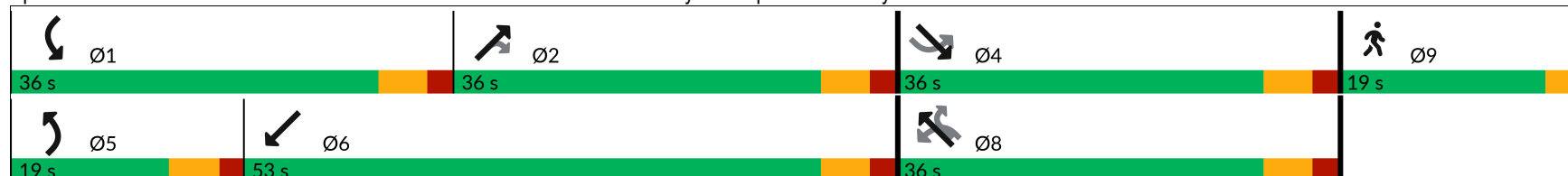

Timings

S:\Jobs\10078 - Durham, NH\Synchro\2035 Design Year No-Build AM.syn

3: Main Street /Dover Road & Newmarket Road/Holiday Inn Express Driveway

01/07/2025























Lane Group	SET	NWT	NWR	NEL	NET	NER	SWL	SWT
Lane Group Flow (vph)	6	191	601	2	217	118	490	320
v/c Ratio	0.01	0.54	0.70	0.01	0.51	0.26	0.79	0.30
Control Delay (s/veh)	0.0	37.5	7.9	46.5	38.7	4.9	40.6	14.3
Queue Delay	0.0	0.0	0.0	0.0	0.0	0.0	0.0	0.0
Total Delay (s/veh)	0.0	37.5	7.9	46.5	38.7	4.9	40.6	14.3
Queue Length 50th (ft)	0	88	0	1	107	0	238	74
Queue Length 95th (ft)	0	217	107	10	231	30	#665	269
Internal Link Dist (ft)	1	409			368			56
Turn Bay Length (ft)			155	35		300		
Base Capacity (vph)	642	479	945	286	708	658	624	1055
Starvation Cap Reductn	0	0	0	0	0	0	0	0
Spillback Cap Reductn	0	0	0	0	0	0	0	0
Storage Cap Reductn	0	0	0	0	0	0	0	0
Reduced v/c Ratio	0.01	0.40	0.64	0.01	0.31	0.18	0.79	0.30

Intersection Summary

95th percentile volume exceeds capacity, queue may be longer.
 Queue shown is maximum after two cycles.

3: Main Street /Dover Road & Newmarket Road/Holiday Inn Express Driveway

01/07/2025

												
Movement	SEL	SET	SER	NWL	NWT	NWR	NEL	NET	NER	SWL	SWT	SWR
Lane Configurations												
Traffic Volume (vph)	3	0	3	172	0	541	2	195	106	441	288	0
Future Volume (vph)	3	0	3	172	0	541	2	195	106	441	288	0
Ideal Flow (vphpl)	1900	1900	1900	1900	1900	1900	1900	1900	1900	1900	1900	1900
Lane Width	12	11	12	12	11	12	11	14	12	12	11	12
Grade (%)		0%			4%			-6%			0%	
Total Lost time (s)		4.0			4.0	4.0	4.0	4.0	4.0	4.0	4.0	
Lane Util. Factor		1.00			1.00	1.00	1.00	1.00	1.00	1.00	1.00	
Frbp, ped/bikes		1.00			1.00	1.00	1.00	1.00	1.00	1.00	1.00	
Flpb, ped/bikes		1.00			1.00	1.00	1.00	1.00	1.00	1.00	1.00	
Frt		0.93			1.00	0.85	1.00	1.00	0.85	1.00	1.00	
Flt Protected		0.98			0.95	1.00	0.95	1.00	1.00	0.95	1.00	
Satd. Flow (prot)		1671			1693	1567	1712	1988	1584	1752	1783	
Flt Permitted		0.90			0.75	1.00	0.95	1.00	1.00	0.95	1.00	
Satd. Flow (perm)		1540			1343	1567	1712	1988	1584	1752	1783	
Peak-hour factor, PHF	0.90	0.90	0.90	0.90	0.90	0.90	0.90	0.90	0.90	0.90	0.90	0.90
Adj. Flow (vph)	3	0	3	191	0	601	2	217	118	490	320	0
RTOR Reduction (vph)	0	5	0	0	0	453	0	0	88	0	0	0
Lane Group Flow (vph)	0	1	0	0	191	148	2	217	30	490	320	0
Confl. Bikes (#/hr)												2
Heavy Vehicles (%)	0%	0%	0%	1%	1%	1%	5%	5%	5%	3%	3%	3%
Turn Type	Perm	NA		Perm	NA	Perm	Prot	NA	Perm	Prot	NA	
Protected Phases		4			8		5	2		1	6	
Permitted Phases	4			8		8			2			
Actuated Green, G (s)		22.5			22.5	22.5	1.2	23.0	23.0	31.0	52.8	
Effective Green, g (s)		24.5			24.5	24.5	3.2	25.0	25.0	33.0	54.8	
Actuated g/C Ratio		0.25			0.25	0.25	0.03	0.25	0.25	0.33	0.55	
Clearance Time (s)		6.0			6.0	6.0	6.0	6.0	6.0	6.0	6.0	
Vehicle Extension (s)		5.0			5.0	5.0	5.0	5.0	5.0	5.0	5.0	
Lane Grp Cap (vph)		380			331	387	55	501	399	582	984	
v/s Ratio Prot							0.00	c0.11		c0.28	0.18	
v/s Ratio Perm		0.00			c0.14	0.09			0.02			
v/c Ratio		0.00			0.58	0.38	0.04	0.43	0.07	0.84	0.33	

3: Main Street /Dover Road & Newmarket Road/Holiday Inn Express Driveway

01/07/2025



Movement	SEL	SET	SER	NWL	NWT	NWR	NEL	NET	NER	SWL	SWT	SWR
Uniform Delay, d1		28.2			32.8	31.1	46.5	31.2	28.3	30.7	12.1	
Progression Factor		1.00			1.00	1.00	1.00	1.00	1.00	1.00	1.00	
Incremental Delay, d2		0.0			3.9	1.3	0.6	1.3	0.2	13.8	0.4	
Delay (s)		28.2			36.7	32.4	47.1	32.4	28.4	44.5	12.5	
Level of Service		C			D	C	D	C	C	D	B	
Approach Delay (s/veh)		28.2			33.4			31.1			31.9	
Approach LOS		C			C			C			C	

Intersection Summary		
HCM 2000 Control Delay (s/veh)	32.4	HCM 2000 Level of Service C
HCM 2000 Volume to Capacity ratio	0.62	
Actuated Cycle Length (s)	99.2	Sum of lost time (s) 14.0
Intersection Capacity Utilization	60.9%	ICU Level of Service B
Analysis Period (min)	15	

c Critical Lane Group



Movement	NWL	NWR	NET	NER	SWL	SWT
Lane Configurations			↔			↔↔
Traffic Volume (veh/h)	0	0	693	46	5	729
Future Volume (Veh/h)	0	0	693	46	5	729
Sign Control	Stop		Free			Free
Grade	0%		-3%			3%
Peak Hour Factor	0.90	0.90	0.90	0.90	0.90	0.90
Hourly flow rate (vph)	0	0	770	51	6	810
Pedestrians						
Lane Width (ft)						
Walking Speed (ft/s)						
Percent Blockage						
Right turn flare (veh)						
Median type			None			None
Median storage (veh)						
Upstream signal (ft)			136			
pX, platoon unblocked	0.91	0.91			0.91	
vC, conflicting volume	1213	796			821	
vC1, stage 1 conf vol						
vC2, stage 2 conf vol						
vCu, unblocked vol	1183	723			751	
tC, single (s)	6.8	6.9			4.2	
tC, 2 stage (s)						
tF (s)	3.5	3.3			2.2	
p0 queue free %	100	100			99	
cM capacity (veh/h)	167	338			769	
Direction, Lane #	NE 1	SW 1	SW 2			
Volume Total	821	276	540			
Volume Left	0	6	0			
Volume Right	51	0	0			
cSH	1700	769	1700			
Volume to Capacity	0.48	0.01	0.32			
Queue Length 95th (ft)	0	1	0			
Control Delay (s/veh)	0.0	0.3	0.0			
Lane LOS			A			
Approach Delay (s/veh)	0.0	0.1				
Approach LOS						
Intersection Summary						
Average Delay			0.1			
Intersection Capacity Utilization			42.6%	ICU Level of Service	A	
Analysis Period (min)			15			



Movement	SEL	SET	SER	NWL	NWT	NWR	NEL	NET	NER	SWL	SWT	SWR
Lane Configurations		↕↔			↕	↗		↕↔			↕↔	
Traffic Volume (veh/h)	0	0	0	33	0	71	0	690	3	30	701	1
Future Volume (Veh/h)	0	0	0	33	0	71	0	690	3	30	701	1
Sign Control		Stop			Stop			Free			Free	
Grade		0%			0%			-3%			3%	
Peak Hour Factor	0.90	0.90	0.90	0.90	0.90	0.90	0.90	0.90	0.90	0.90	0.90	0.90
Hourly flow rate (vph)	0	0	0	37	0	79	0	767	3	33	779	1
Pedestrians												
Lane Width (ft)												
Walking Speed (ft/s)												
Percent Blockage												
Right turn flare (veh)												
Median type												
								None			None	
Median storage veh												
Upstream signal (ft)												
								223				
pX, platoon unblocked	0.91	0.91		0.91	0.91	0.91					0.91	
vC, conflicting volume	1693	1616	390	1224	1615	769	780				770	
vC1, stage 1 conf vol												
vC2, stage 2 conf vol												
vCu, unblocked vol	1712	1627	390	1196	1626	695	780				697	
tC, single (s)	7.5	6.5	6.9	7.5	6.5	6.9	4.1				4.1	
tC, 2 stage (s)												
tF (s)	3.5	4.0	3.3	3.5	4.0	3.3	2.2				2.2	
p0 queue free %	100	100	100	71	100	78	100				96	
cM capacity (veh/h)	41	90	614	127	90	354	833				814	
Direction, Lane #												
	SE 1	NW 1	NW 2	NE 1	SW 1	SW 2						
Volume Total	0	37	79	770	423	391						
Volume Left	0	37	0	0	33	0						
Volume Right	0	0	79	3	0	1						
cSH	1700	127	354	833	814	1700						
Volume to Capacity	0.00	0.29	0.22	0.00	0.04	0.23						
Queue Length 95th (ft)	0	28	21	0	3	0						
Control Delay (s/veh)	0.0	44.7	18.1	0.0	1.2	0.0						
Lane LOS	A	E	C		A							
Approach Delay (s/veh)	0.0	26.6		0.0	0.6							
Approach LOS	A	D										
Intersection Summary												
Average Delay			2.1									
Intersection Capacity Utilization			51.4%		ICU Level of Service				A			
Analysis Period (min)			15									

10: Dover Road & Site Driveway

01/07/2025



Movement	SEL	SER	NEL	NET	SWT	SWR
Lane Configurations						
Traffic Volume (veh/h)	0	0	0	761	732	0
Future Volume (Veh/h)	0	0	0	761	732	0
Sign Control	Stop			Free	Free	
Grade	0%			-3%	3%	
Peak Hour Factor	0.90	0.90	0.90	0.90	0.90	0.90
Hourly flow rate (vph)	0	0	0	846	813	0
Pedestrians						
Lane Width (ft)						
Walking Speed (ft/s)						
Percent Blockage						
Right turn flare (veh)						
Median type				None	None	
Median storage (veh)						
Upstream signal (ft)	313					
pX, platoon unblocked	0.91					
vC, conflicting volume	1659	813	813			
vC1, stage 1 conf vol						
vC2, stage 2 conf vol						
vCu, unblocked vol	1675	813	813			
tC, single (s)	6.4	6.2	4.1			
tC, 2 stage (s)						
tF (s)	3.5	3.3	2.2			
p0 queue free %	100	100	100			
cM capacity (veh/h)	97	382	814			
Direction, Lane #	SE 1	NE 1	SW 1			
Volume Total	0	846	813			
Volume Left	0	0	0			
Volume Right	0	0	0			
cSH	1700	814	1700			
Volume to Capacity	0.00	0.00	0.48			
Queue Length 95th (ft)	0	0	0			
Control Delay (s/veh)	0.0	0.0	0.0			
Lane LOS	A					
Approach Delay (s/veh)	0.0	0.0	0.0			
Approach LOS	A					
Intersection Summary						
Average Delay	0.0					
Intersection Capacity Utilization	43.4%			ICU Level of Service	A	
Analysis Period (min)	15					

2035 Design Year Build Mitigated Weekday Morning Peak Hour



10: Dover Road & Site Driveway

01/07/2025



Movement	SEL	SER	NEL	NET	SWT	SWR
Lane Configurations						
Traffic Volume (veh/h)	53	47	49	711	699	34
Future Volume (Veh/h)	53	47	49	711	699	34
Sign Control	Stop			Free	Free	
Grade	0%			-3%	3%	
Peak Hour Factor	0.90	0.90	0.90	0.90	0.90	0.90
Hourly flow rate (vph)	59	52	54	790	777	38
Pedestrians						
Lane Width (ft)						
Walking Speed (ft/s)						
Percent Blockage						
Right turn flare (veh)						
Median type				None	None	
Median storage veh						
Upstream signal (ft)	313					
pX, platoon unblocked	0.91					
vC, conflicting volume	1694	796	815			
vC1, stage 1 conf vol						
vC2, stage 2 conf vol						
vCu, unblocked vol	1713	796	815			
tC, single (s)	6.4	6.2	4.1			
tC, 2 stage (s)						
tF (s)	3.5	3.3	2.2			
p0 queue free %	31	87	93			
cM capacity (veh/h)	86	390	812			
Direction, Lane #	SE 1	NE 1	NE 2	SW 1		
Volume Total	111	54	790	815		
Volume Left	59	54	0	0		
Volume Right	52	0	0	38		
cSH	135	812	1700	1700		
Volume to Capacity	0.82	0.07	0.46	0.48		
Queue Length 95th (ft)	128	5	0	0		
Control Delay (s/veh)	98.8	9.7	0.0	0.0		
Lane LOS	F	A				
Approach Delay (s/veh)	98.8	0.6	0.0			
Approach LOS	F					
Intersection Summary						
Average Delay	6.5					
Intersection Capacity Utilization	53.2%			ICU Level of Service	A	
Analysis Period (min)	15					

2035 Design Year Build Mitigated Weekday Evening Peak Hour



10: Dover Road & Site Driveway

01/07/2025



Movement	SEL	SER	NEL	NET	SWT	SWR
Lane Configurations						
Traffic Volume (veh/h)	22	18	20	829	810	15
Future Volume (Veh/h)	22	18	20	829	810	15
Sign Control	Stop			Free	Free	
Grade	0%			-3%	3%	
Peak Hour Factor	0.90	0.90	0.90	0.90	0.90	0.90
Hourly flow rate (vph)	24	20	22	921	900	17
Pedestrians	7			7	7	
Lane Width (ft)	12.0			11.5	12.0	
Walking Speed (ft/s)	3.5			3.5	3.5	
Percent Blockage	1			1	1	
Right turn flare (veh)						
Median type				None	None	
Median storage veh						
Upstream signal (ft)	313					
pX, platoon unblocked	0.80					
vC, conflicting volume	1888	923	924			
vC1, stage 1 conf vol						
vC2, stage 2 conf vol						
vCu, unblocked vol	1981	923	924			
tC, single (s)	6.4	6.2	4.1			
tC, 2 stage (s)						
tF (s)	3.5	3.3	2.2			
p0 queue free %	55	94	97			
cM capacity (veh/h)	53	326	739			
Direction, Lane #	SE 1	NE 1	NE 2	SW 1		
Volume Total	44	22	921	917		
Volume Left	24	22	0	0		
Volume Right	20	0	0	17		
cSH	85	739	1700	1700		
Volume to Capacity	0.52	0.03	0.54	0.54		
Queue Length 95th (ft)	56	2	0	0		
Control Delay (s/veh)	85.6	10.0	0.0	0.0		
Lane LOS	F	B				
Approach Delay (s/veh)	85.6	0.2		0.0		
Approach LOS	F					
Intersection Summary						
Average Delay			2.1			
Intersection Capacity Utilization			55.7%	ICU Level of Service	B	
Analysis Period (min)			15			

2035 Design Year Build Mitigated Saturday Midday Peak Hour





Movement	SEL	SER	NEL	NET	SWT	SWR
Lane Configurations						
Traffic Volume (veh/h)	31	25	33	821	823	22
Future Volume (Veh/h)	31	25	33	821	823	22
Sign Control	Stop			Free	Free	
Grade	0%			-3%	3%	
Peak Hour Factor	0.90	0.90	0.90	0.90	0.90	0.90
Hourly flow rate (vph)	34	28	37	912	914	24
Pedestrians						
Lane Width (ft)						
Walking Speed (ft/s)						
Percent Blockage						
Right turn flare (veh)						
Median type				None	None	
Median storage (veh)						
Upstream signal (ft)	313					
pX, platoon unblocked	0.78					
vC, conflicting volume	1912	926	938			
vC1, stage 1 conf vol						
vC2, stage 2 conf vol						
vCu, unblocked vol	2026	926	938			
tC, single (s)	6.4	6.2	4.1			
tC, 2 stage (s)						
tF (s)	3.5	3.3	2.2			
p0 queue free %	29	91	95			
cM capacity (veh/h)	48	329	735			
Direction, Lane #	SE 1	NE 1	NE 2	SW 1		
Volume Total	62	37	912	938		
Volume Left	34	37	0	0		
Volume Right	28	0	0	24		
cSH	78	735	1700	1700		
Volume to Capacity	0.80	0.05	0.54	0.55		
Queue Length 95th (ft)	98	4	0	0		
Control Delay (s/veh)	141.9	10.2	0.0	0.0		
Lane LOS	F	B				
Approach Delay (s/veh)	141.9	0.4		0.0		
Approach LOS	F					
Intersection Summary						
Average Delay	4.7					
Intersection Capacity Utilization	54.6%			ICU Level of Service	A	
Analysis Period (min)	15					